

FEATURES

- Powder iron core material
- Magnetically shielded, low EMI
- High current carrying capacity, Low core losses
- Frequency range up to 3MHz
- Operate temperature range $-40^{\circ}\text{C} \sim +125^{\circ}\text{C}$ (Including self temp. rise)
- RoHS compliant

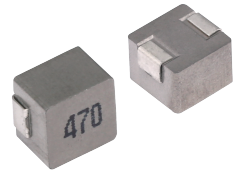

APPLICATIONS

- Voltage Regulator Module (VRM)
- Multi-phase regulators
- Point-of-load modules
- Smart phone POL modules
- SSD modules
- Notebook regulators
- Battery power systems
- Graphics cards
- Data networking and storage systems

PRODUCT IDENTIFICATION

FSA0650 -1R0 M T

1 2 3 4 5

1:Product Series:Metal Alloy Molding Power Inductor

2:Dimensions:

3: Initial inductance value: 1R0 = 1.0uH

4:Tolerance of Inductance:M: $\pm 20\%$

5:Packing:Tape Carrier Package

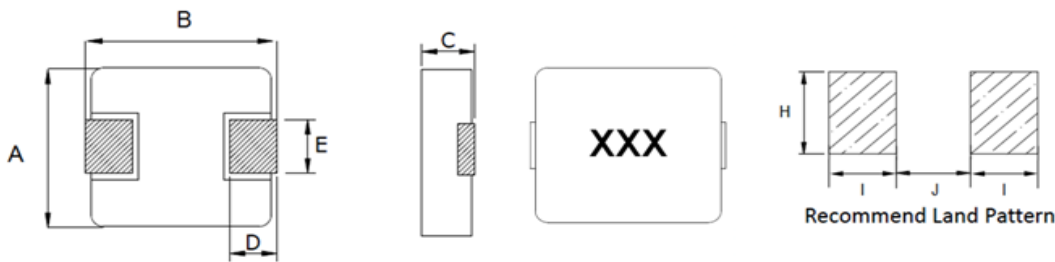

Series	A	B	C	D	E	I Typ.	J Typ.	H Typ.
FSA0650	6.6±0.2	7.0±0.3	4.8±0.2	1.6±0.3	3.0±0.3	2.35	3.7	3.5

Electrical Properties:

Part Number	Inductance	DC Resistance	Saturation Current		Heat Rating Current	
	@100KHz,1V	Max.	Max.	Typ.	Max.	Typ.
Units	μH	mΩ	A		A	
Symbol	L	DCR	Isat		Irms	
FSA0650-R47MT	0.47±20%	3.9	16.8	21.0	17.0	20.0
FSA0650-R68MT	0.68±20%	4.5	14.4	18.0	14.5	16.5
FSA0650-1R0MT	1.0±20%	6.6	12.8	16.0	10.0	12.0
FSA0650-1R5MT	1.5±20%	10	10.4	13.0	8.20	9.50
FSA0650-2R2MT	2.2±20%	12.5	8.80	11.0	8.00	9.00
FSA0650-3R3MT	3.3±20%	22	8.00	10.0	7.60	8.50
FSA0650-4R7MT	4.7±20%	29	6.40	8.00	5.00	6.00
FSA0650-6R8MT	6.8±20%	41	5.04	6.30	4.00	5.80
FSA0650-8R2MT	8.2±20%	48	4.40	5.50	4.80	5.50
FSA0650-100MT	10±20%	60	4.24	5.30	3.80	4.50
FSA0650-150MT	15±20%	90	3.20	4.00	2.60	3.10
FSA0650-220MT	22±20%	140	2.80	3.50	2.00	2.60
FSA0650-330MT	33±20%	190	2.40	3.00	1.80	2.30
FSA0650-470MT	47±20%	230	2.08	2.60	1.50	2.00

Notes

- ※1: All test data is referenced to 20°C ambient;
- ※2: Rated current: Isat or Irms, whichever is smaller;
- ※3: Isat(Typ): DC current at which the inductance drops approximate 30% from its value without current;
- ※4: Isat(Max): DC current at which the inductance drops approximate 20% from its value without current;
- ※5: Irms(Typ): DC current that causes the temperature rise (ΔT =40°C) from 20°C ambient.
- ※6: Irms(Max): DC current that causes the temperature rise (ΔT =20°C) from 20°C ambient.
- ※7: Absolute maximum voltage 30VDC

TYPICAL ELECTRICAL CHARACTERISTICS

FSA0650-R47MT

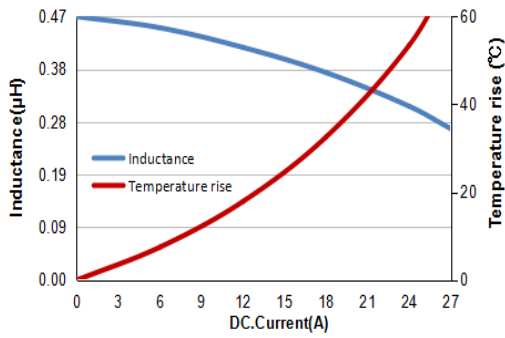

FSA0650-R68MT

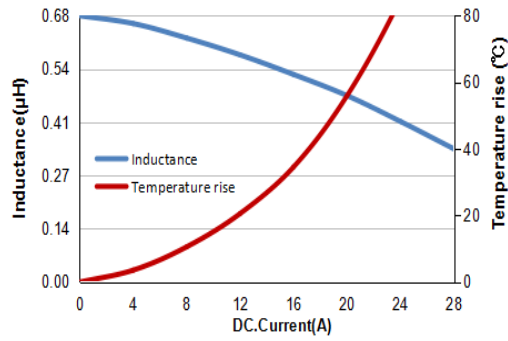

FSA0650-1R0MT

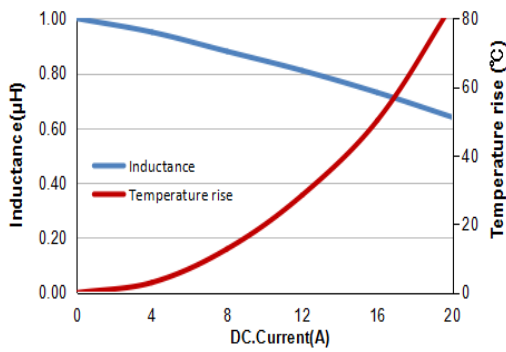

FSA0650-1R5MT

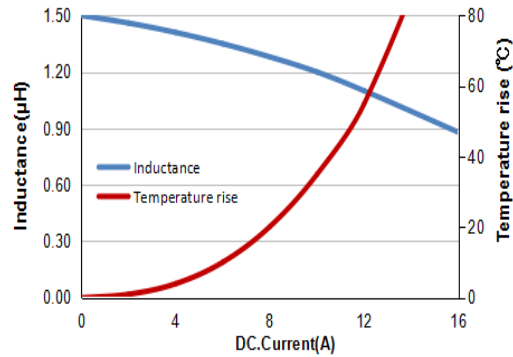

FSA0650-2R2MT

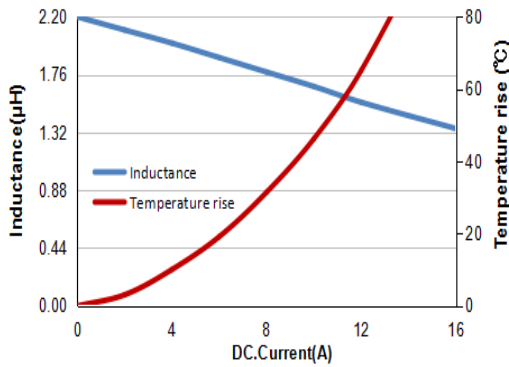

FSA0650-3R3MT

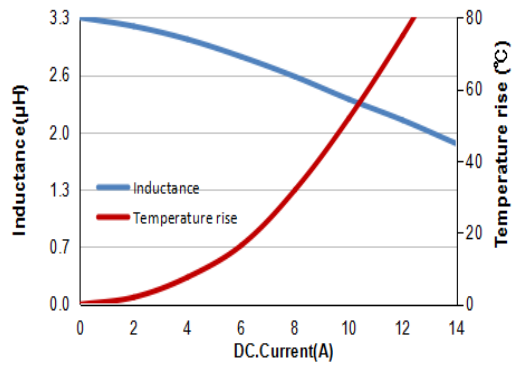

FSA0650-4R7MT

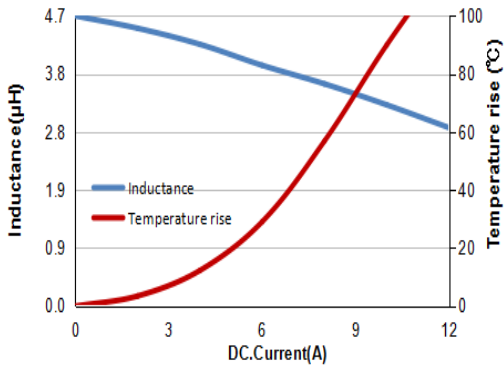

FSA0650-6R8MT

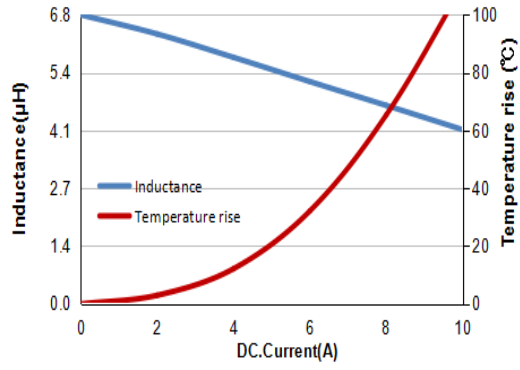

FSA0650-8R2MT

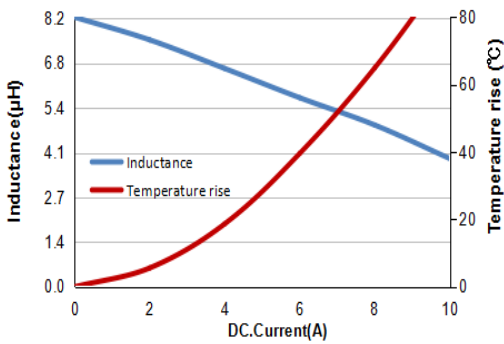

FSA0650-100MT

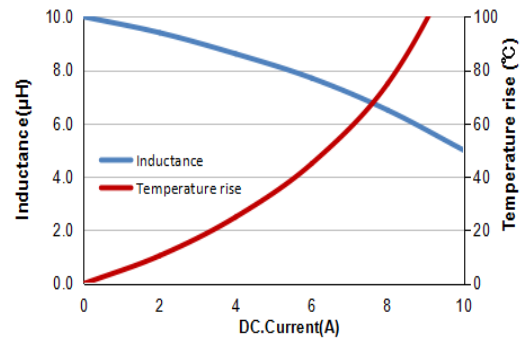

FSA0650-150MT

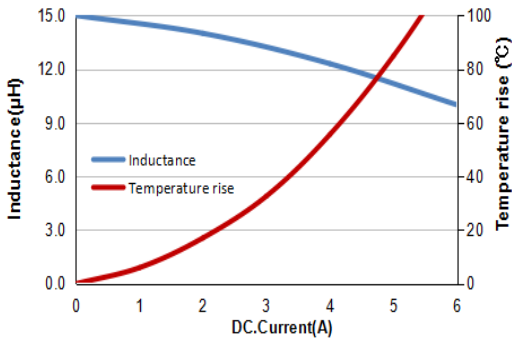

FSA0650-220MT

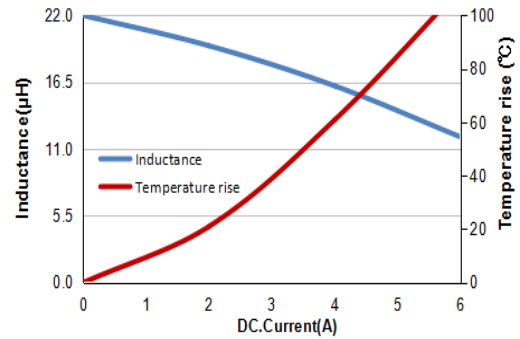

FSA0650-330MT

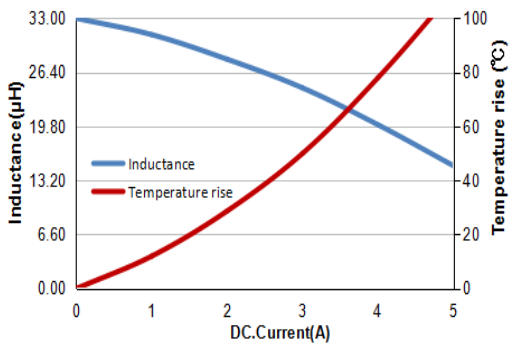

FSA0650-470MT

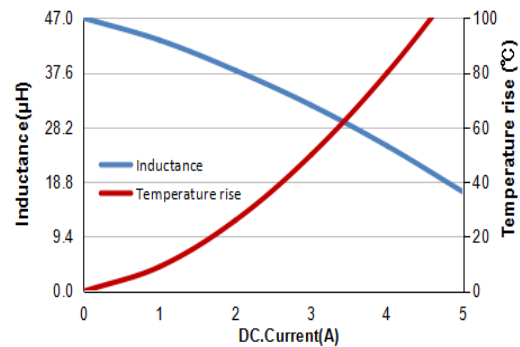

Reliability and Test Condition

Mechanical Reliability		
Item	Specification and Requirement	Test Method
Solderability	The surface of terminal immersed shall be minimum of 95% covered with a new coating of solder	Solder heat proof: 1. Preheating: 160 ± 10 °C 2. Retention time: 245 ± 5 °C for 2 ± 0.5 seconds
Vibration	Inductance change: Within $\pm 10\%$ Without mechanical damage such as break	1. Vibration frequency: (10 Hz to 55 Hz to 10Hz) in 60 seconds as a period 2. Vibration time: Period cycled for 2 hours in each of 3 mutual perpendicular directions. 3. Amplitude: 1.5 mm max.
Shock	Inductance change: Within $\pm 10\%$ Without mechanical damage such as break	1. Peak value: 100 G 2. Duration of pulse: 11ms 3. 3 times in each positive and negative direction of 3 mutual perpendicular directions
Endurance Reliability		
Item	Specification and Requirement	Test Method
Thermal Shock	Inductance change: Within $\pm 10\%$ Without distinct damage in appearance	1. Repeat 100 cycles as follow: (-55 ± 2 °C; 30 ± 3 min) →(Room temp., 5 min) → ($+125 \pm 2$ °C, 30 ± 3 min) → (Room temp., 5 min) 2. Recovery: $48 + 4 / -0$ hours of recovery under the standard condition after the test.
High Temperature Resistance	Inductance change: Within $\pm 10\%$ Without distinct damage in appearance	1. Environment condition: 85 ± 2 °C Applied Current: Rated current 2. Duration: $1000 + 4 / -0$ hours
Humidity Resistance	Inductance change: Within $\pm 10\%$ Without distinct damage in appearance	1. Environment condition: 60 ± 2 °C Humidity: 90–95% Applied Current: Rated current 2. Duration: $1000 + 4 / -0$ hours
Low Temperature Store	Inductance change: Within $\pm 10\%$ Without distinct damage in appearance	Store temperature: -55 ± 2 °C, $1000 + 4 / -0$ hours
High Temperature Store	Inductance change: Within $\pm 10\%$ Without distinct damage in appearance	Store temperature: $+125 \pm 2$ °C, $1000 + 4 / -0$ hours

Tape Packaging Dimensions

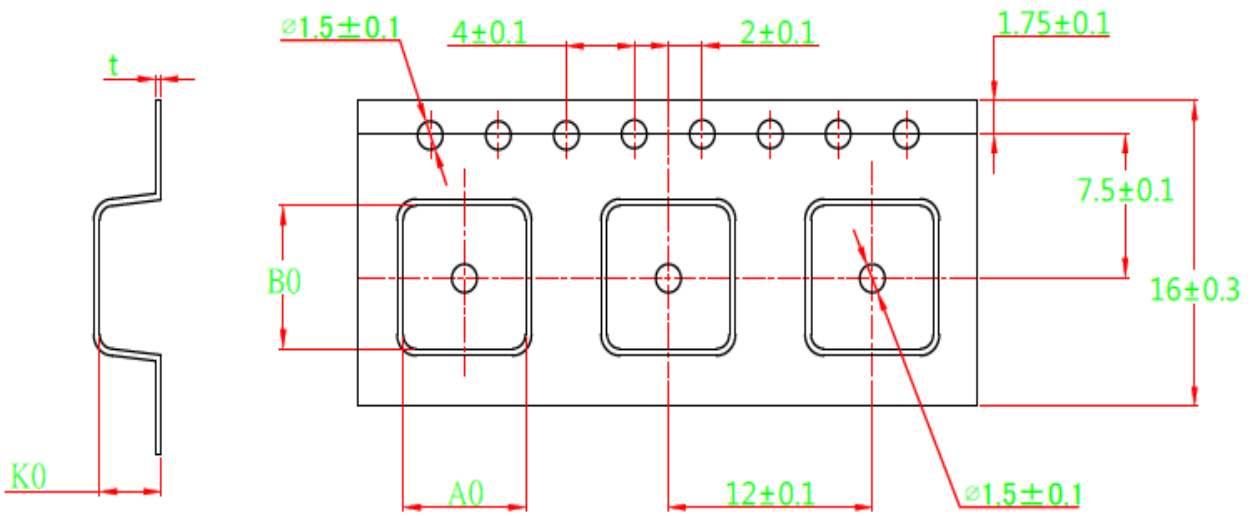

A0	B0	K0	t
7.2 ± 0.10	7.5 ± 0.10	5.6 ± 0.15	0.31 ± 0.05

Reel Dimensions

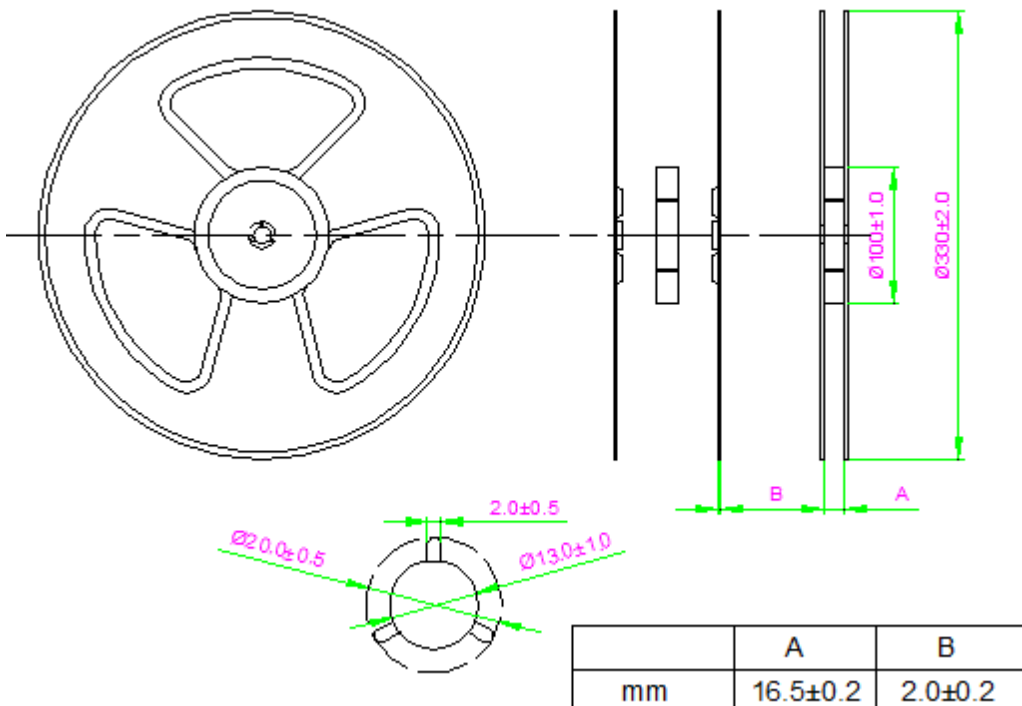

	A	B
mm	16.5 ± 0.2	2.0 ± 0.2

Packaging Quantity: 1000PCS/Reel

Recommended Soldering Technologies

(1) Re-flowing Profile

Preheat condition: 150 ~200°C/60~120sec.

Allowed time above 217°C: 60~90sec.

Max temp: 260°C

Max time at max temp: 10 sec.

Solder paste: Sn/3.0Ag/0.5Cu

Allowed Reflow time: 2x max

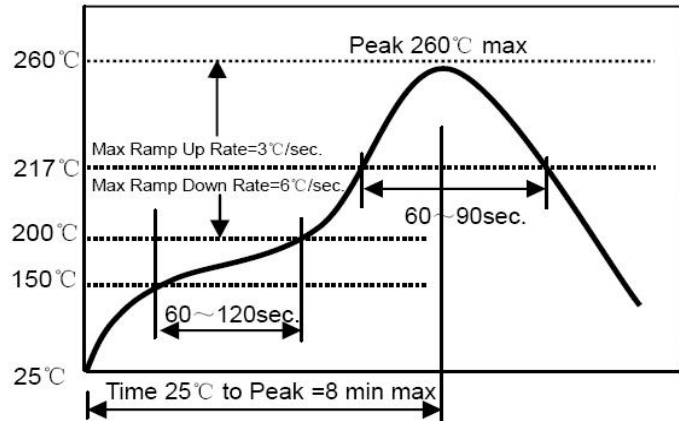

(2) Iron Soldering Profile

Iron soldering power: Max. 30W

Pre-heating: 150°C/60sec.

Soldering Tip temperature: 350°C Max.

Soldering time: 3sec. Max.

Solder paste: Sn/3.0Ag/0.5Cu

Max. 1 times for iron soldering

