

## Description:

This N-Channel MOSFET uses advanced trench technology and design to provide excellent  $R_{DS(on)}$  with low gate charge. It can be used in a wide variety of applications.

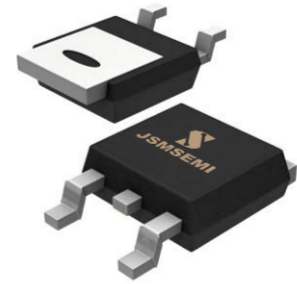

TO-252

## Features:

- 1)  $V_{DS}=30V, I_D=55A, R_{DS(ON)} < 10m\ \Omega @ V_{GS}=10V$
- 2) Low gate charge.
- 3) Green device available.
- 4) Advanced high cell density trench technology for ultra low  $R_{DS(ON)}$ .
- 5) Excellent package for good heat dissipation.

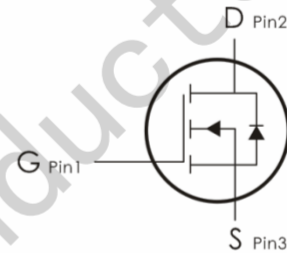

## Absolute Maximum Ratings: ( $T_C=25^\circ C$ unless otherwise noted)

Symbol	Parameter	Ratings	Units
$V_{DS}$	Drain-Source Voltage	30	V
$V_{GS}$	Gate-Source Voltage	$\pm 20$	V
$I_D$	Continuous Drain Current- $T_C=25^\circ C^1$	55	A
	Continuous Drain Current- $T_C=100^\circ C$	30	
	Pulsed Drain Current <sup>2</sup>	112	
$E_{AS}$	Single Pulse Avalanche Energy <sup>3</sup>	24.2	mJ
$I_{AS}$	Avalanche Current	22	A
$P_D$	Power Dissipation, $T_C=25^\circ C^4$	37.5	W
$T_J, T_{STG}$	Operating and Storage Junction Temperature Range	-55 to +175	$^\circ C$

## Thermal Characteristics:

Symbol	Parameter	Max	Units
$R_{\theta JC}$	Thermal Resistance, Junction to Case <sup>1</sup>	4	$^\circ C/W$
$R_{\theta JA}$	Thermal Resistance Junction-Ambient <sup>1</sup>	62	$^\circ C/W$

**Electrical Characteristics:** ( $T_C=25^\circ\text{C}$  unless otherwise noted)

Symbol	Parameter	Conditions	Min	Typ	Max	Units
<b>Off Characteristics</b>						
$BV_{DSS}$	Drain-Source Breakdown Voltage	$V_{GS}=0V, I_D=250\ \mu\text{A}$	30	---	---	V
$I_{DSS}$	Zero Gate Voltage Drain Current	$V_{GS}=0V, V_{DS}=30V$	---	---	1	$\mu\text{A}$
$I_{GSS}$	Gate-Source Leakage Current	$V_{GS}=\pm 20V, V_{DS}=0A$	---	---	$\pm 100$	nA
<b>On Characteristics</b>						
$V_{GS(th)}$	GATE-Source Threshold Voltage	$V_{GS}=V_{DS}, I_D=250\ \mu\text{A}$	1.2	---	2.5	V
$R_{DS(ON)}$	Drain-Source On Resistance <sup>2</sup>	$V_{GS}=10V, I_D=30A$	---	7.5	10	m $\Omega$
		$V_{GS}=4.5V, I_D=15A$	---	11	18	
<b>Dynamic Characteristics</b>						
$C_{iss}$	Input Capacitance	$V_{DS}=15V, V_{GS}=0V, f=1\text{MHz}$	---	940	---	pF
$C_{oss}$	Output Capacitance		---	131	---	
$C_{rss}$	Reverse Transfer Capacitance		---	109	---	
<b>Switching Characteristics</b>						
$t_{d(on)}$	Turn-On Delay Time	$V_{DD}=15V, I_D=15A,$ $V_{GS}=10V, R_{GEN}=3.3\Omega$	---	4	---	ns
$t_r$	Rise Time		---	8	---	ns
$t_{d(off)}$	Turn-Off Delay Time		---	31	---	ns
$t_f$	Fall Time		---	4	---	ns
$Q_g$	Total Gate Charge	$V_{GS}=4.5V, V_{DS}=15V,$ $I_D=15A$	---	9.8	---	nC
$Q_{gs}$	Gate-Source Charge		---	4.2	---	nC
$Q_{gd}$	Gate-Drain "Miller" Charge		---	3.6	---	nC
<b>Drain-Source Diode Characteristics</b>						

<b>V<sub>SD</sub></b>	Source-Drain Diode Forward Voltage	V <sub>GS</sub> =0V, I <sub>S</sub> =1A	---	---	1	V
<b>I<sub>S</sub></b>	Continuous Source Current <sup>1,5</sup>	V <sub>G</sub> =V <sub>D</sub> =0V, Force Current	---	---	43	A
<b>I<sub>SM</sub></b>	Pulsed Source Current <sup>2,5</sup>		---	--	112	Ns
<b>T<sub>rr</sub></b>	Reverse Recovery Time	I <sub>F</sub> =30A, dI/dt=100A/μs, T <sub>J</sub> =25°C	---	8.5	---	
<b>Q<sub>rr</sub></b>	Reverse Recovery Charge		---	2.2	---	

**Notes:**

- 1.The data tested by surface mounted on a 1 inch<sup>2</sup> FR-4 board with 2OZ copper.
- 2.The data tested by pulsed, pulse width ≤ 300us, duty cycle ≤ 2%
- 3.The EAS data shows Max. rating. The test condition is V<sub>DD</sub>=25V, V<sub>GS</sub>=10V, L=0.1mH, I<sub>AS</sub>=22A
- 4.The power dissipation is limited by 175°C junction temperature
- 5.The data is theoretically the same as I<sub>D</sub> and I<sub>DM</sub>, in real applications, should be limited by total power dissipation.

**Typical Characteristics:** (T<sub>C</sub>=25°C unless otherwise noted)

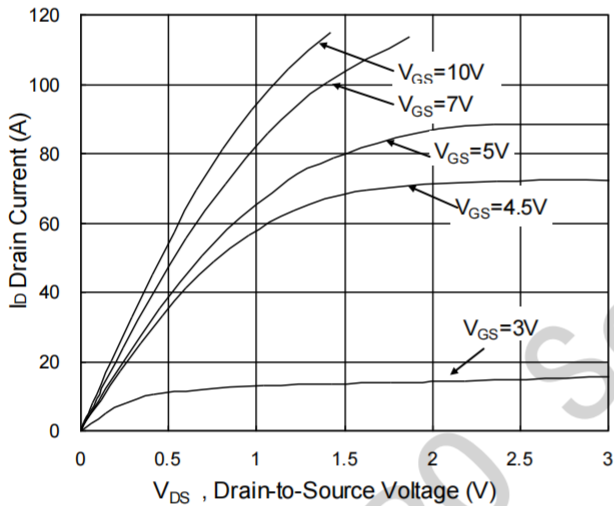

**Fig.1 Typical Output Characteristics**

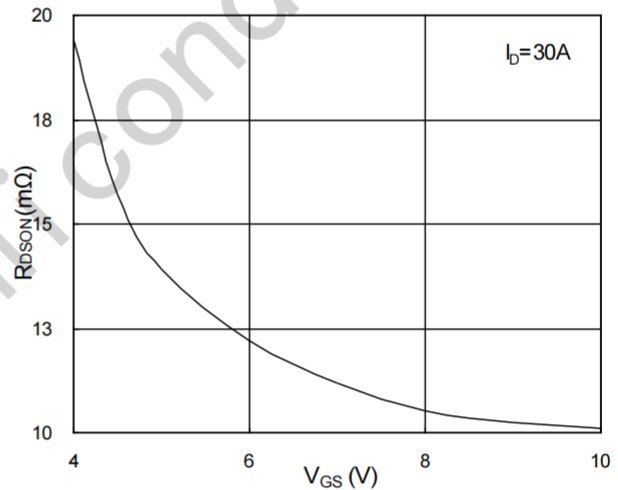

**Fig.2 On-Resistance vs. G-S Voltage**

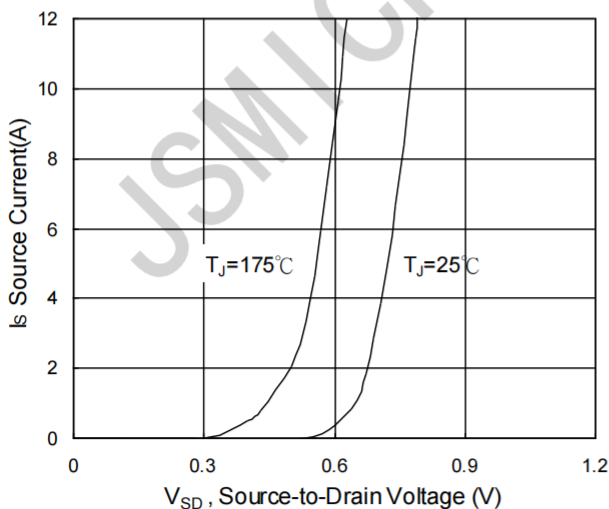

**Fig.3 Forward Characteristics of Reverse**

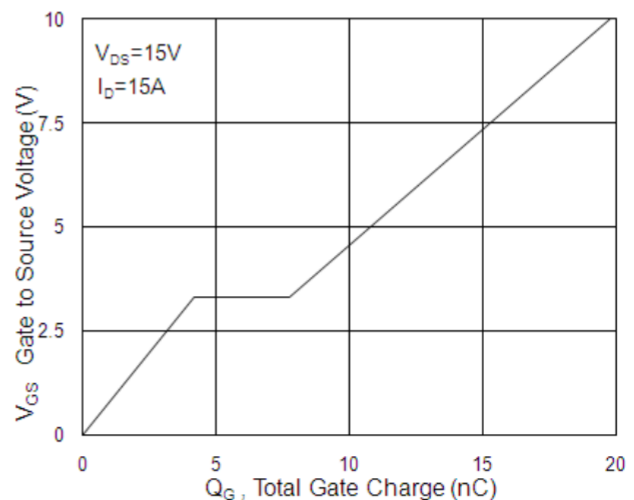

**Fig.4 Gate-Charge Characteristics**

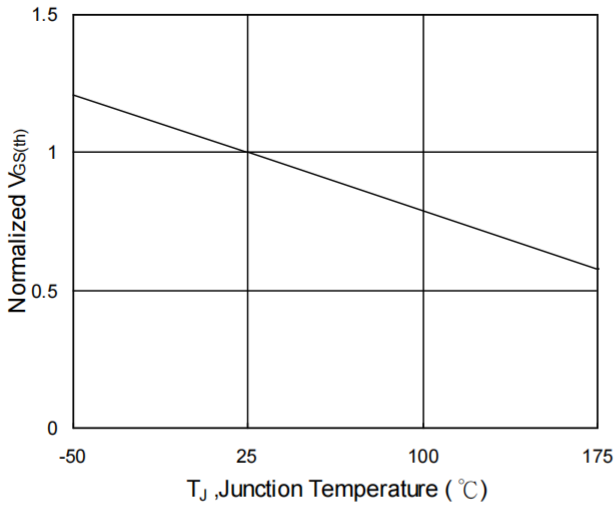

**Fig.5 Normalized  $V_{GS(th)}$  vs.  $T_J$**

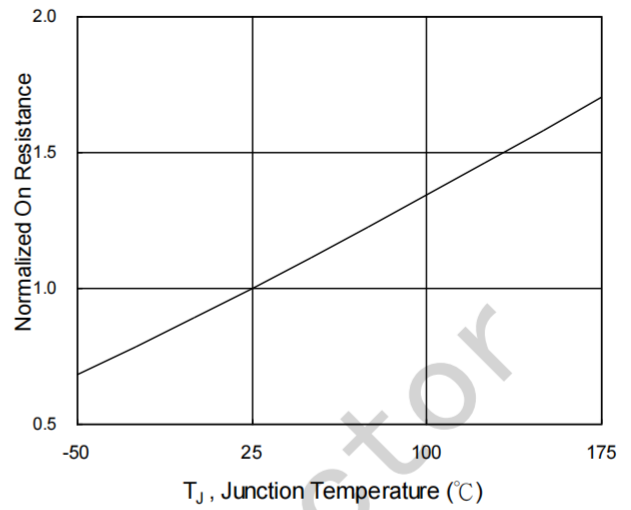

**Fig.6 Normalized  $R_{DS(on)}$  vs.  $T_J$**

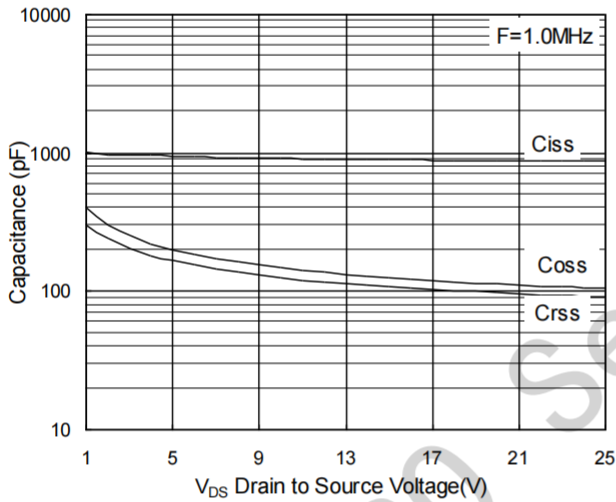

**Fig.7 Capacitance**

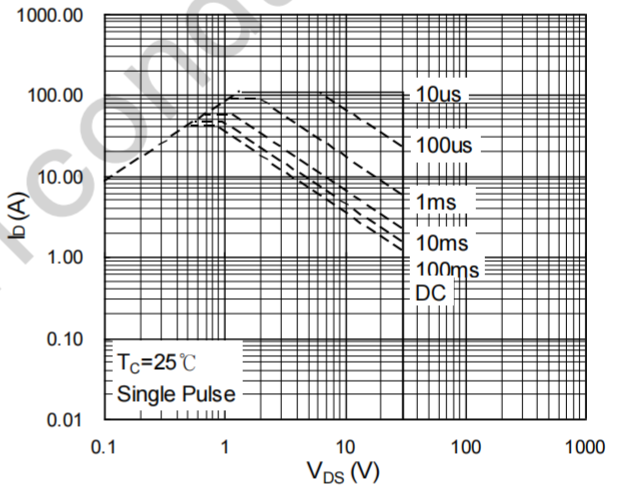

**Fig.8 Safe Operating Area**

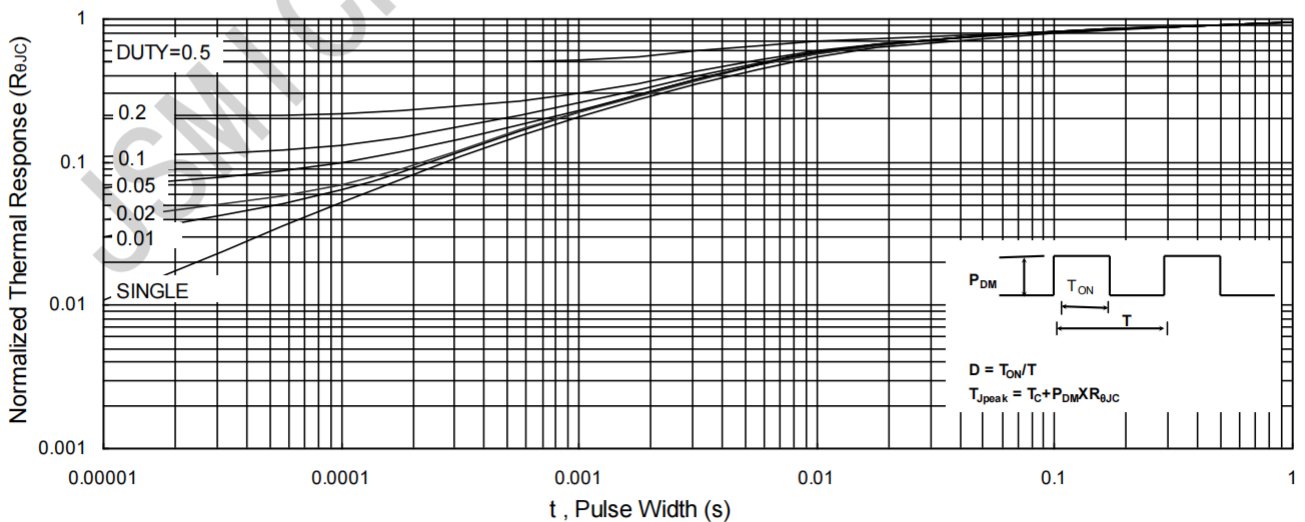

**Fig.9 Normalized Maximum Transient Thermal Impedance**

## Package Information

TO-252

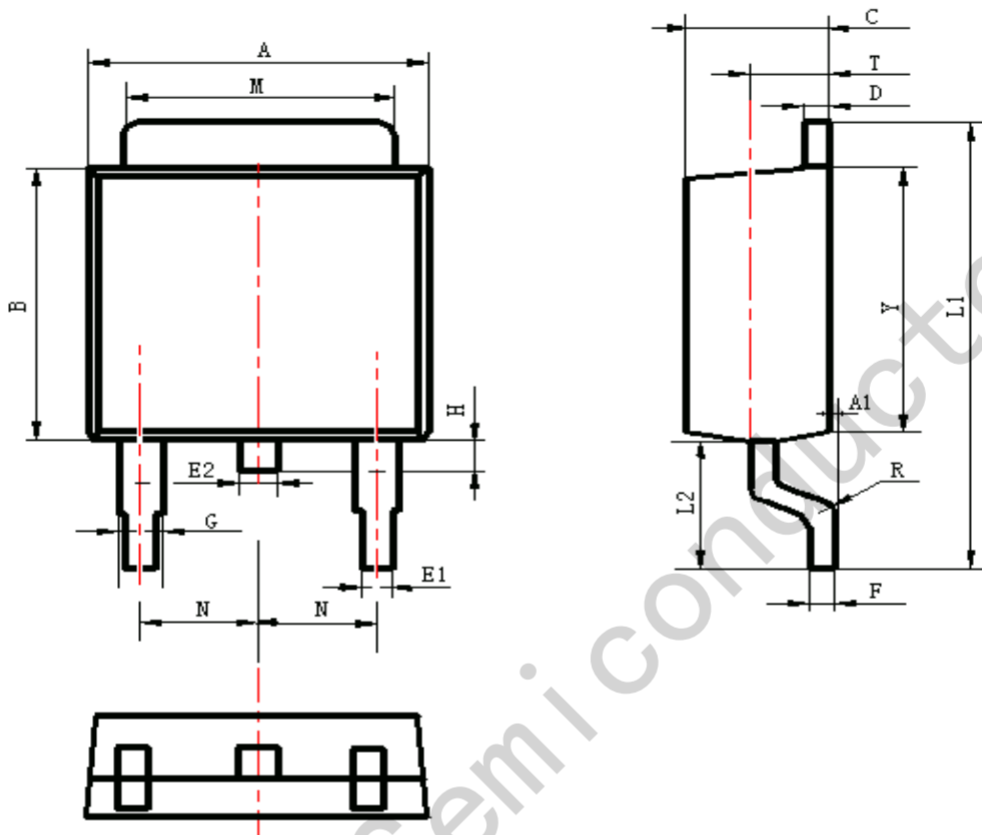

Symbol	Dimensions In Millimeters		Dimensions In Inches	
	Min.	Max.	Min.	Max.
A	6.30	6.90	0.248	0.272
A1	0.00	0.16	0.000	0.006
B	5.70	6.30	0.224	0.248
C	2.10	2.50	0.083	0.098
D	0.30	0.70	0.012	0.028
E1	0.60	0.90	0.024	0.035
E2	0.70	1.00	0.028	0.039
F	0.30	0.60	0.012	0.024
G	0.70	1.20	0.028	0.047
L1	9.60	10.50	0.378	0.413
L2	2.70	3.10	0.106	0.122
H	0.40	1.00	0.016	0.039
M	5.10	5.50	0.201	0.217
N	2.09	2.49	0.082	0.098
R	0.30		0.012	
T	1.40	1.60	0.055	0.063
Y	5.10	6.30	0.201	0.248