

## FEATURES

- Fast switching
- 100% avalanche tested
- Improved dv/dt capability

## APPLICATIONS

- Switch Mode Power Supply (SMPS)
- Uninterruptible Power Supply (UPS)
- Power Factor Correction (PFC)

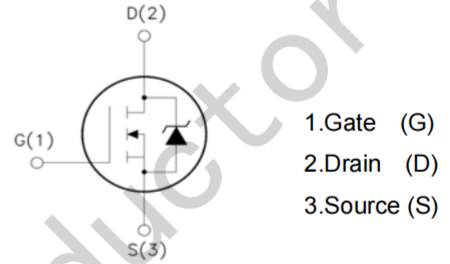
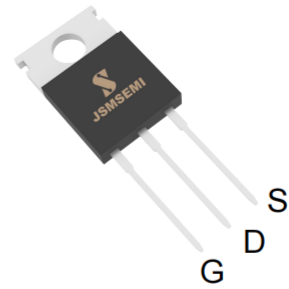

### Device Marking and Package Information

Device	Package	Marking
NTP75N06G	TO-220	NTP75N06G

### Absolute Maximum Ratings $T_C = 25^\circ\text{C}$ , unless otherwise noted

Parameter	Symbol	Value	Unit
		TO-220	
Drain-Source Voltage ( $V_{GS} = 0V$ )	$V_{DSS}$	60	V
Continuous Drain Current	$I_D$	110	A
Pulsed Drain Current (note1)	$I_{DM}$	440	A
Gate-Source Voltage	$V_{GSS}$	$\pm 20$	V
Single Pulse Avalanche Energy (note2)	$E_{AS}$	653	mJ
Avalanche Current (note1)	$I_{AS}$	40	A
Repetitive Avalanche Energy (note1)	$E_{AR}$	391.8	mJ
Power Dissipation ( $T_C = 25^\circ\text{C}$ )	$P_D$	358	W
Operating Junction and Storage Temperature Range	$T_J, T_{stg}$	-55~+150	$^\circ\text{C}$

### Thermal Resistance

Parameter	Symbol	Value	Unit
Thermal Resistance, Junction-to-Case	$R_{thJC}$	0.65	$^\circ\text{C/W}$
Thermal Resistance, Junction-to-Ambient	$R_{thJA}$	62	

**Specifications**  $T_J = 25^{\circ}\text{C}$ , unless otherwise noted

Parameter	Symbol	Test Conditions	Value			Unit
			Min.	Typ.	Max.	
<b>Static</b>						
Drain-Source Breakdown Voltage	$V_{(BR)DSS}$	$V_{GS} = 0V, I_D = 250\mu A$	60	--	--	V
Zero Gate Voltage Drain Current	$I_{DSS}$	$V_{DS} = 60V, V_{GS} = 0V, T_J = 25^{\circ}\text{C}$	--	--	1	$\mu A$
Gate-Source Leakage	$I_{GSS}$	$V_{GS} = \pm 20V, V_{DS} = 0V$	--	--	$\pm 100$	nA
Gate-Source Threshold Voltage	$V_{GS(th)}$	$V_{DS} = V_{GS}, I_D = 250\mu A$	2.0	--	4.0	V
Drain-Source On-Resistance (Note3)	$R_{DS(on)}$	$V_{GS} = 10V, I_D = 60A$	--	0.005	0.006	$\Omega$
Forward Transconductance	gfs	$V_{DS} = 25V, I_D = 60A$	--	17	--	S
<b>Dynamic</b>						
Input Capacitance	$C_{iss}$	$V_{GS} = 0V,$ $V_{DS} = 25V,$ $f = 1.0\text{MHz}$	--	2699	--	pF
Output Capacitance	$C_{oss}$		--	1016	--	
Reverse Transfer Capacitance	$C_{rss}$		--	487	--	
Total Gate Charge	$Q_g$	$V_{DS} = 28V, V_{GS} = 15V,$ $I_D = 42A$	--	115	--	nC
Gate-Source Charge	$Q_{gs}$		--	13	--	
Gate-Drain Charge	$Q_{gd}$		--	55	--	
Turn-on Delay Time	$t_{d(on)}$	$V_{DD} = 28V, I_D = 42A,$ $V_{GS} = 15V, R_G = 25\Omega$	--	52	--	ns
Turn-on Rise Time	$t_r$		--	142	--	
Turn-off Delay Time	$t_{d(off)}$		--	355	--	
Turn-off Fall Time	$t_f$		--	230	--	
<b>Drain-Source Body Diode Characteristics</b>						
Continuous Source Current	$I_{SD}$	$T_J = 25^{\circ}\text{C}, I_{SD} = 60A, V_{GS} = 0V$	--	--	110	A
Pulsed Source Current	$I_{SM}$		--	--	440	
Body Forward Voltage	$V_{SD}$	$I_S = 40A, V_{GS} = 0V$	--	--	1.2	V
Reverse Recovery Time	$t_{rr}$	$V_{GS} = 0V, I_F = 180A,$ $di_F/dt = 100A/\mu s$	--	100	--	ns
Reverse Recovery Charge	$Q_{rr}$		--	0.33	--	$\mu C$

**Notes**

1. Repetitive Rating: Pulse width limited by maximum junction temperature
2.  $L = 1\text{mH}, V_{DD} = 50V, R_G = 25\Omega, \text{Starting } T_J = 25^{\circ}\text{C}$
3. Pulse Test: Pulse width  $\leq 300\mu s$ , Duty Cycle  $\leq 1\%$

Typical Characteristics  $T_J = 25^\circ\text{C}$ , unless otherwise noted

Figure 1. Output Characteristics ( $T_J = 25^\circ\text{C}$ )

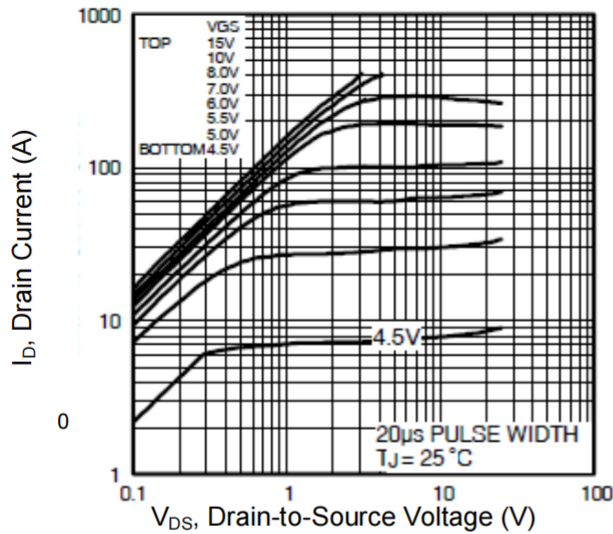

Figure 2. Body Diode Forward Voltage

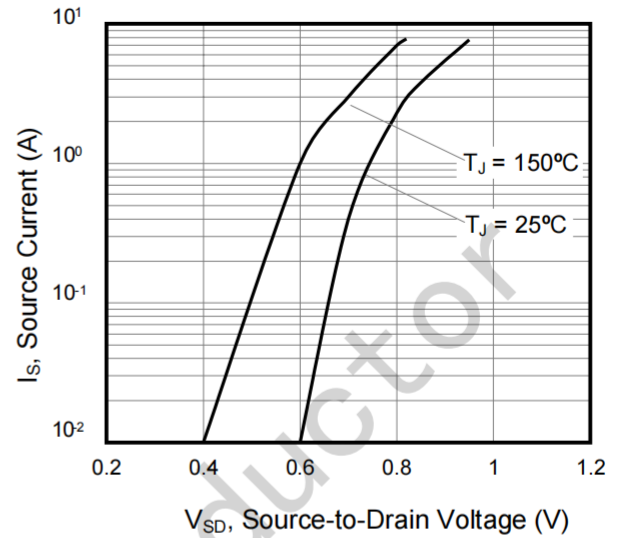

Figure 3. Drain Current vs. Temperature

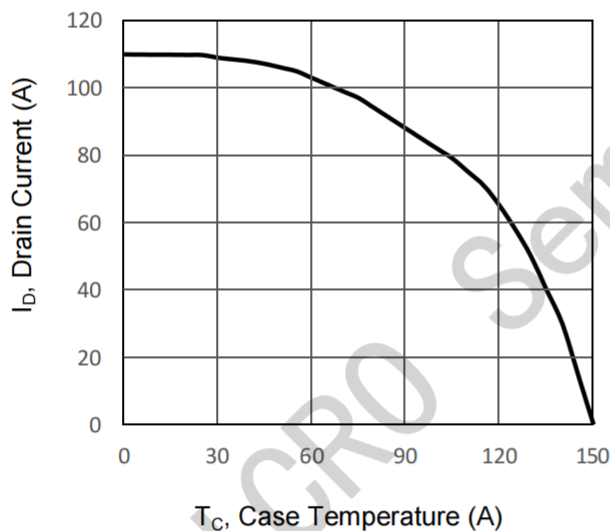

Figure 4.  $BV_{DSS}$  Variation vs. Temperature

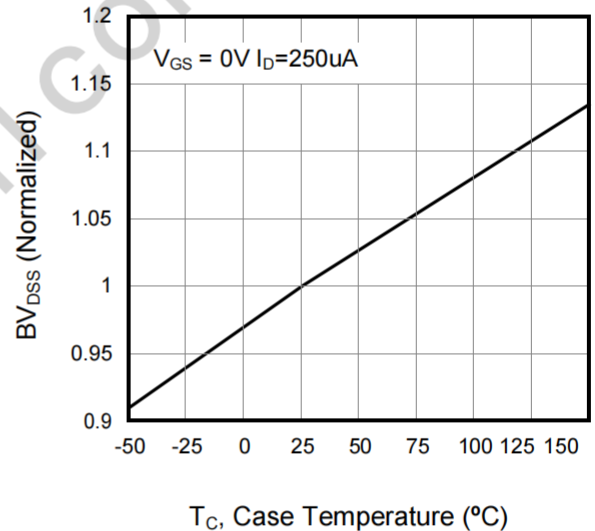

Figure 5. Transfer Characteristics

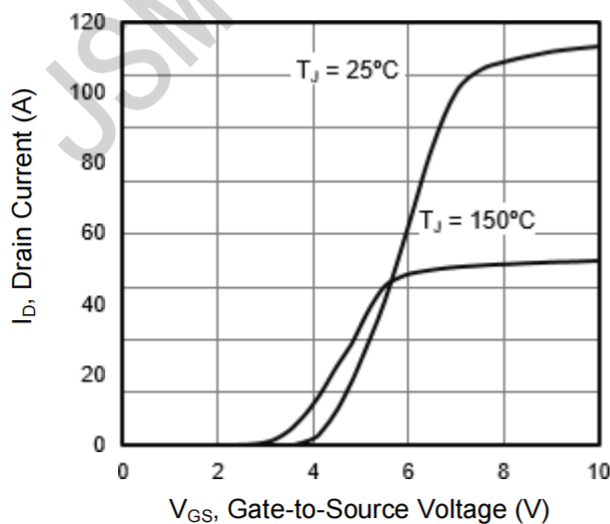
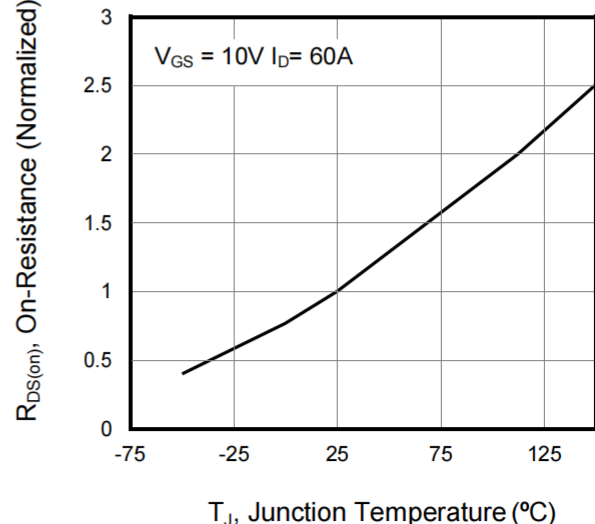

Figure 6. On-Resistance vs. Temperature



Typical Characteristics  $T_J = 25^\circ\text{C}$ , unless otherwise noted

Figure 7. Capacitance

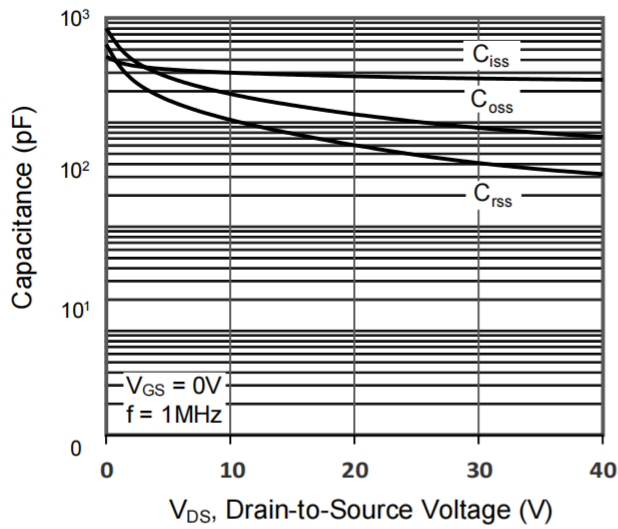

Figure 8. Gate Charge

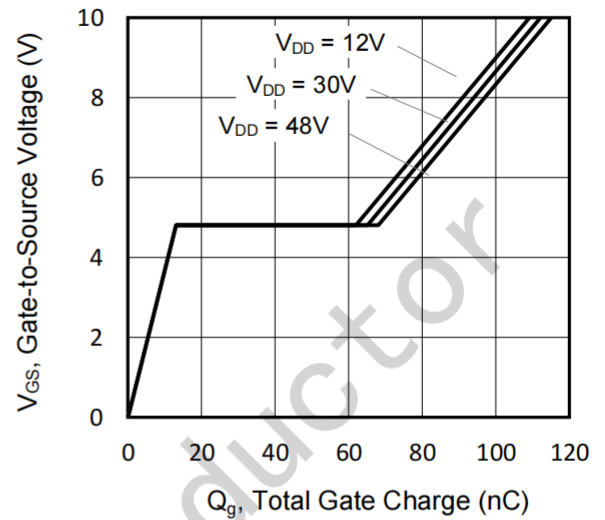

Figure 9. Transient Thermal Impedance  
TO-220

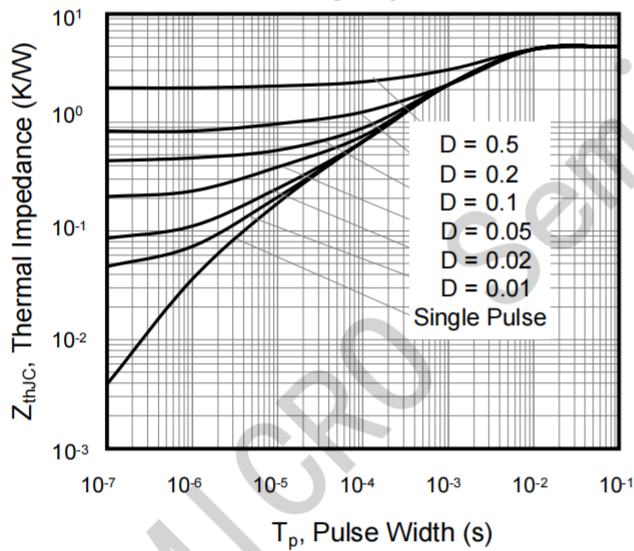

Figure A: Gate Charge Test Circuit and Waveform

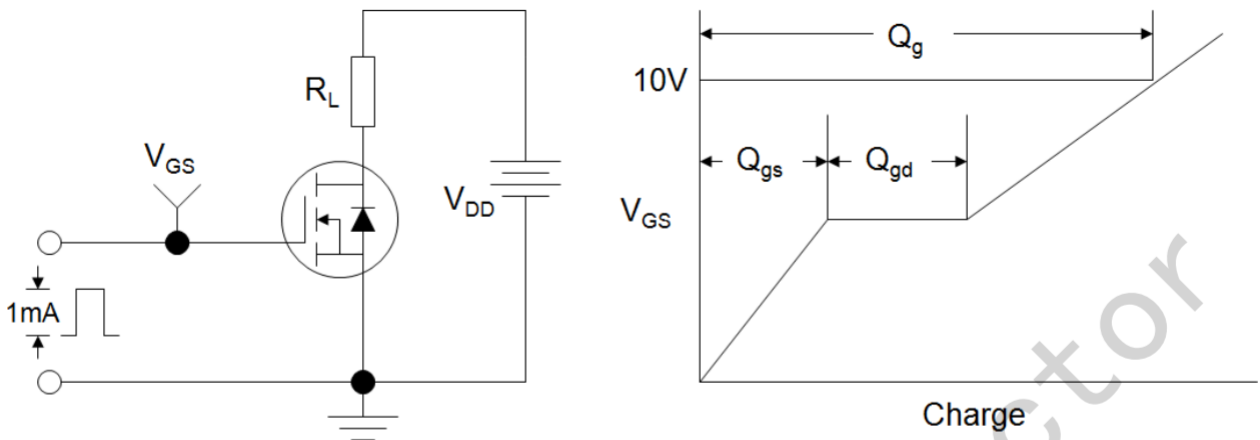

Figure B: Resistive Switching Test Circuit and Waveform

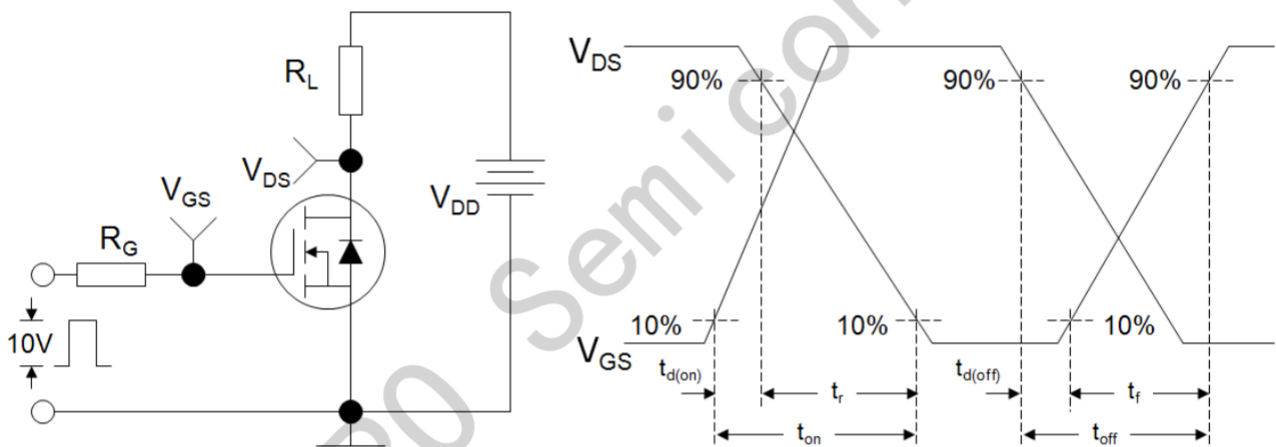
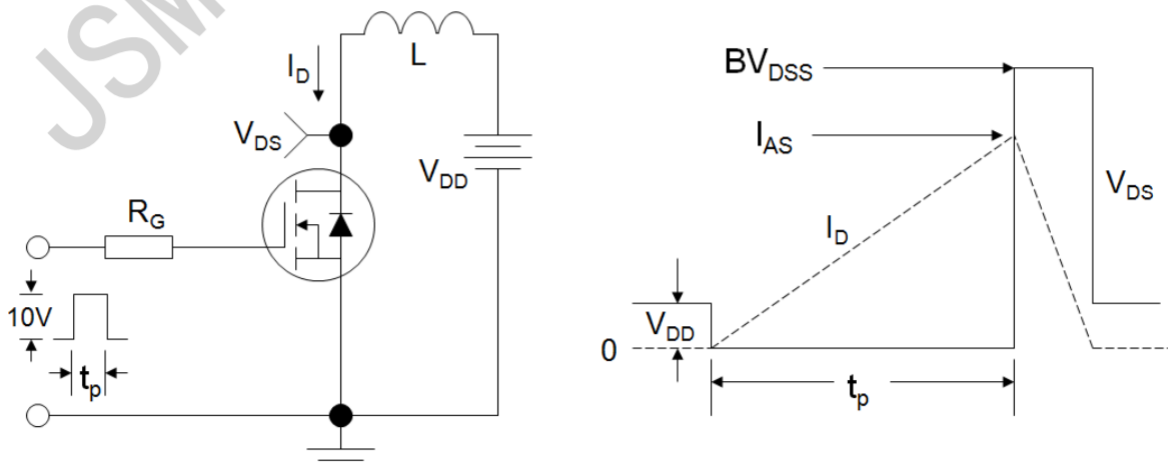
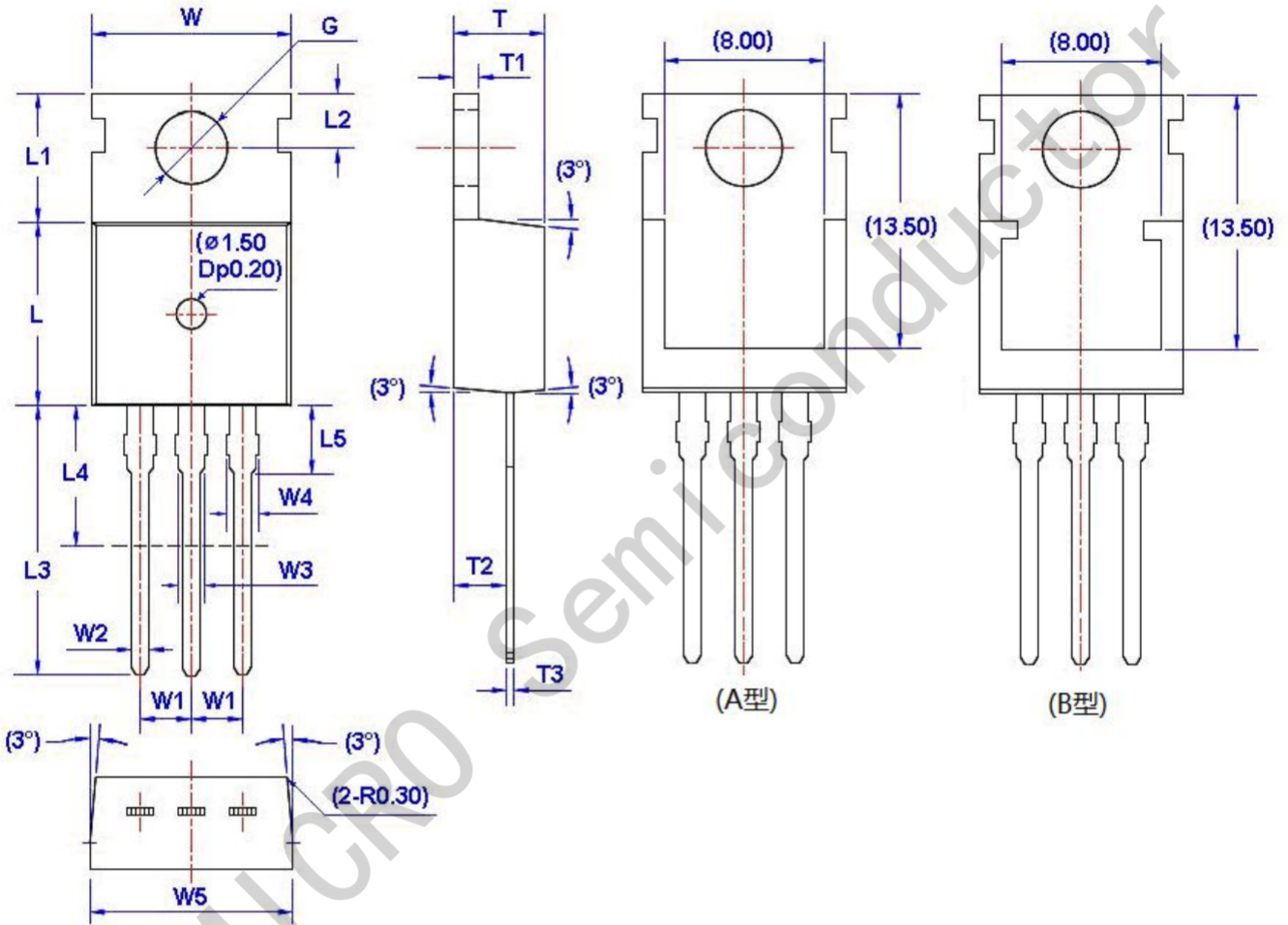

Figure C: Unclamped Inductive Switching Test Circuit and Waveform



**Package Information**

TO-220



Unit: mm

Symbol	Size		Symbol	Size		Symbol	Size		Symbol	Size	
	Min	Max		Min	Max		Min	Max		Min	Max
W	9.66	10.28	W5	9.80	10.20	L4**	6.20	6.60	T3	0.45	0.60
W1	2.54 (TYP)		L	9.00	9.40	L5	2.79	3.30	G(Φ)	3.50	3.70
W2	0.70	0.95	L1	6.40	6.80	T	4.30	4.70			
W3	1.17	1.37	L2	2.70	2.90	T1	1.15	1.40			
W4*	1.32	1.72	L3	12.70	14.27	T2	2.20	2.60			