

标记 MARK	ECN编号/变更内容 ECN NO/DEFINITION					修改 REVISE	日期 DATE			核准 APPROVE	
PIN	DIM A	DIM B	PIN	DIM A	DIM B	PIN	DIM A	DIM B	PIN	DIM A	DIM B
1	—	2.00	11	20.00	22.00	21	40.00	42.00	31	60.00	62.00
2	2.00	4.00	12	22.00	24.00	22	42.00	44.00	32	62.00	64.00
3	4.00	6.00	13	24.00	26.00	23	44.00	46.00	33	64.00	66.00
4	6.00	8.00	14	26.00	28.00	24	46.00	48.00	34	66.00	68.00
5	8.00	10.00	15	28.00	30.00	25	48.00	50.00	35	68.00	70.00
6	10.00	12.00	16	30.00	32.00	26	50.00	52.00	36	70.00	72.00
7	12.00	14.00	17	32.00	34.00	27	52.00	54.00	37	72.00	74.00
8	14.00	16.00	18	34.00	36.00	28	54.00	56.00	38	74.00	76.00
9	16.00	18.00	19	36.00	38.00	29	56.00	58.00	39	76.00	78.00
10	18.00	20.00	20	38.00	40.00	30	58.00	60.00	40	78.00	80.00

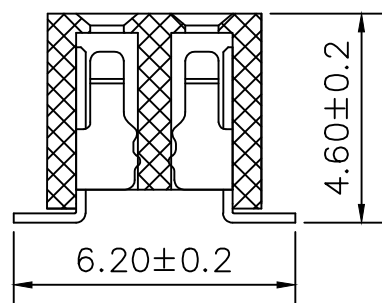
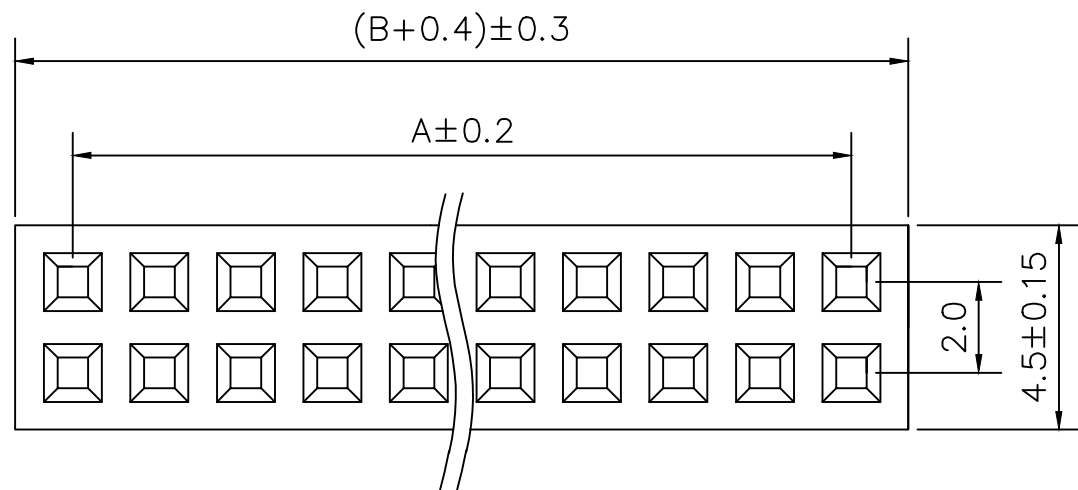

SPECIFICATIONS

Current Rating: 1.5 Amps  
 Withstanding Voltage: AC 500V  
 Insulation Resistance: 1000MΩ Min  
 Contact Resistance: 20mΩ Max  
 Operation Temperature: -40°to+105°  
 Insulator Material: Polyester  
 Contact Material: Brass  
 Standard: PA6T  
 Contact Plating: Gold Flash  
 Max.Processing Temp: 200°C for 30-60seconds  
 (255°C for 5seconds)

H	PC	PB
4.3	6.2	4.6

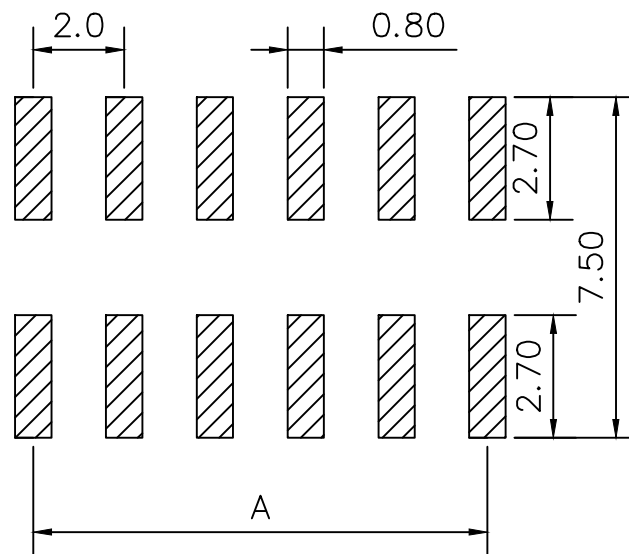
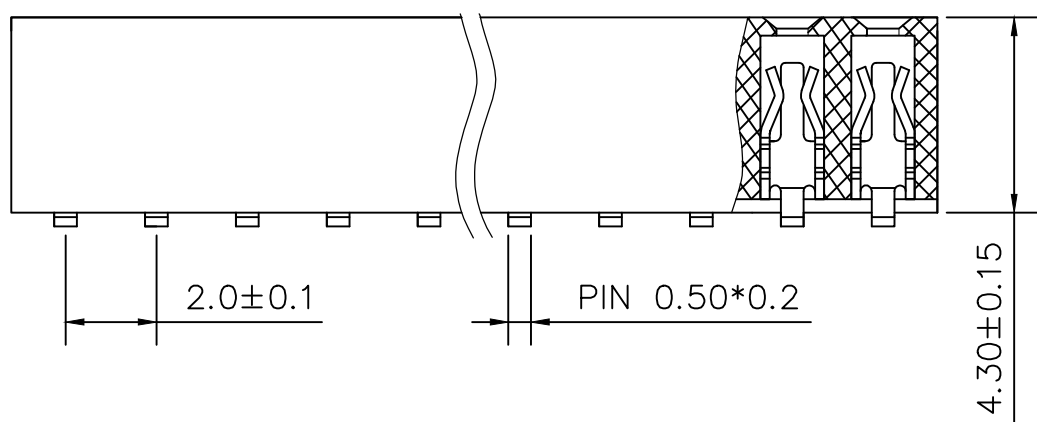

RECOMMEND P.C.B LAYOUT  
 PCB TOLERANCE: ±0.05 (TOP VIEW)

2	接触	铜	镀金	
1	基座	PA6T	本色	
序号	品名	材质	电镀/颜色	备注

	深圳市虹成电子有限公司		品名 TITLE	排母	
			料号 PART NO	HC-PM200-4.3H-2x29PS	
一般公差 TOLERANCE		比列 SCALE	1:1		
X : ±0.30	X° : ±5°	单位 UNIT	MM		
X.X : ±0.25	X.X° : ±1°	张数 PART NO	1 OF 1		
X.XX : ±0.20	X.XX° : ±0.5°	版本 REV	A		制图 DRAW
			审核 CHECKED	AhYe	
			批准 APPROVE	夏操云	
					赵亮亮

