

## 1. Features

- $R_{DS(on)}=4.5m\Omega$  (typ.)@  $V_{GS}=10V$
- Lead free and Green Device Available
- Low  $R_{ds-on}$  to Minimize Conductive Loss
- High avalanche Current

## 2. Application

- Load Switch
- SMPS

## 3. Pin configuration

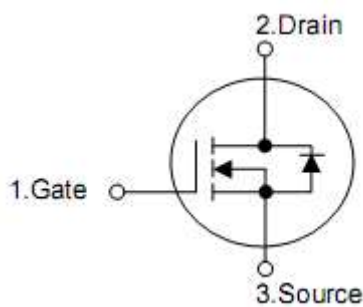

Pin DFN5*6	Pin TO-252	Function
4	1	Gate
5,6,7,8	2	Drain
1,2,3	3	Source

#### 4. Ordering Information

Part Number	Package	Brand
KND3403A	TO-252	KIA
KNY3403A	DFN5*6	KIA

#### 5. Absolute maximum ratings

TC=25 °C unless otherwise specified

Parameter		Symbol	Ratings	Unit
Drain-to-Source Voltage		$V_{DSS}$	30	V
Gate-to-Source Voltage		$V_{GSS}$	±20	
Continuous Drain Current	$T_C=25\text{ °C}$ (Silicon limited)	$I_D$ $V_{GS}=10V$	85	A
	$T_C=100\text{ °C}$ (Silicon limited)		61	
	$T_C=25\text{ °C}$ (Package limited)		50	
	$T_C=25\text{ °C}$ (Silicon limited)	$I_D$ $V_{GS}=4.5V$	76	
	$T_C=100\text{ °C}$ (Silicon limited)		54	
	$T_C=25\text{ °C}$ (Package limited)		50	
Pulsed Drain Current Tested	$T_C=25\text{ °C}$ (Silicon Limit)	$I_{DM}$	340	
Avalanche Current (L=0.5mH)		$I_{AS}$	25	A
Avalanche Energy (L=0.5mH)		$E_{AS}$	156	mJ
Maximum power Dissipation	$T_C=25\text{ °C}$	$P_D$	71	W
	$T_C=100\text{ °C}$		35	
Junction & Storage Temperature Range		$T_J$ & $T_{STG}$	-55 to 175	°C

#### 6. Thermal characteristics

Parameter	Symbol	Ratings	Units
Thermal resistance, Junction-case	$R_{\theta JC}$	2.1	°C/W
Thermal resistance, junction-ambient	$R_{\theta JA}$	106	°C/W

## 7. Electrical characteristics

(T<sub>J</sub>=25°C, unless otherwise notes)

Parameter	Symbol	Conditions	Min	Typ	Max	Units
Static characteristics						
Drain-source breakdown voltage	BV <sub>DSS</sub>	V <sub>GS</sub> =0V, I <sub>D</sub> =250μA	30	-	-	V
Zero Gate Voltage Drain Current	I <sub>DSS</sub>	V <sub>DS</sub> =24V, V <sub>GS</sub> =0V	-	-	1	μA
Gate threshold voltage	V <sub>GS(th)</sub>	V <sub>DS</sub> =V <sub>GS</sub> , I <sub>D</sub> =250μA	0.8	-	2.0	V
Gate leakage current	I <sub>GSS</sub>	V <sub>GS</sub> =±20V, V <sub>DS</sub> =0V	-	-	±100	nA
Drain-source on-resistance	R <sub>DS(on)</sub>	V <sub>GS</sub> =10V, I <sub>D</sub> =30A	-	4.5	5.5	mΩ
		V <sub>GS</sub> =4.5V, I <sub>D</sub> =30A	-	5.5	7	
Forward Transconductance	g <sub>fs</sub>	V <sub>DS</sub> =5V, I <sub>D</sub> =90A	-	74	-	S
Dynamic characteristics						
Gate Resistance	R <sub>G</sub>	V <sub>GS</sub> =0V, V <sub>DS</sub> =0V Frequency=1MHz	-	2.0	-	Ω
Input capacitance	C <sub>iss</sub>	V <sub>DS</sub> =15V, V <sub>GS</sub> =0V, F=1MHz	-	3000	-	pF
Output capacitance	C <sub>oss</sub>		-	330	-	pF
Reverse transfer capacitance	C <sub>rss</sub>		-	285	-	pF
Turn-on delay time	t <sub>d(on)</sub>	V <sub>DS</sub> =15V, I <sub>D</sub> =1A, V <sub>GS</sub> =4.5V, R <sub>G</sub> =3Ω	-	20	-	ns
Rise time	t <sub>r</sub>		-	32	-	ns
Turn-off delay time	t <sub>d(off)</sub>		-	60	-	ns
Fall time	t <sub>f</sub>		-	33	-	ns
Gate Charge Characteristics						
Total gate charge	Q <sub>g</sub>	V <sub>DS</sub> =25V, I <sub>D</sub> =14A, V <sub>GS</sub> =4.5V	-	25	-	nC
Gate-source charge	Q <sub>gs</sub>		-	3.2	-	nC
Gate-drain charge	Q <sub>gd</sub>		-	12	-	nC
Diode characteristics						
Diode forward voltage	V <sub>SD</sub>	V <sub>GS</sub> =0V, I <sub>SD</sub> =25A	-	0.82	1.3	V
Drain Continuous Forward current	I <sub>S</sub>		-	-	50	A
Reverse recovery time	t <sub>rr</sub>	I <sub>S</sub> =20A di/dt=100A/μs	-	14	-	ns
Reverse recovery charge	Q <sub>rr</sub>		-	2.8	-	μC

**8. Typical Characteristics**

**Figure 1. Typ. Output Characteristics**

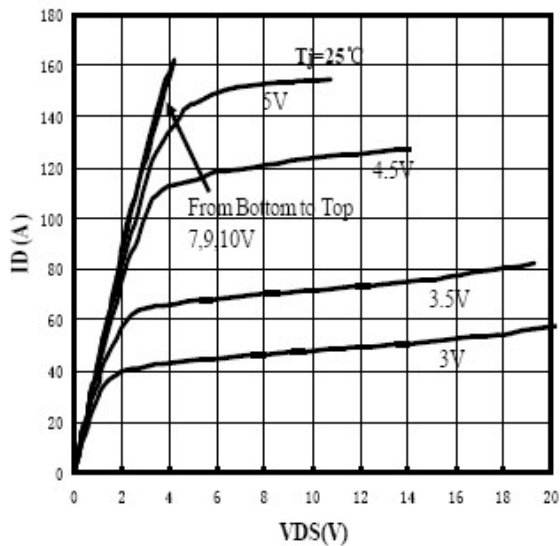

**Figure 2. Typ. Output Characteristics**

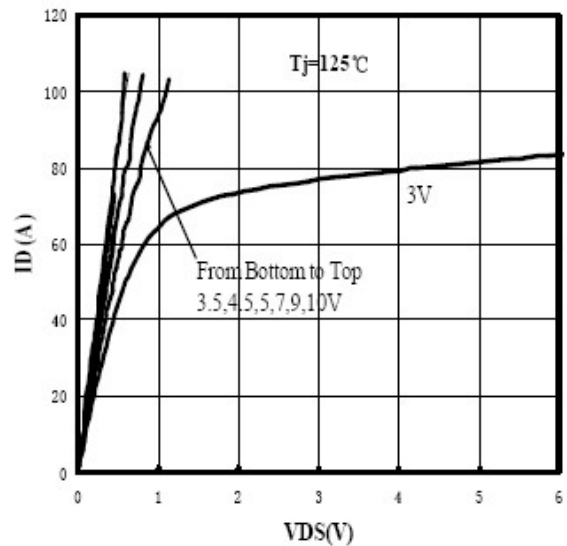

**Figure 3. Transfer Characteristics**

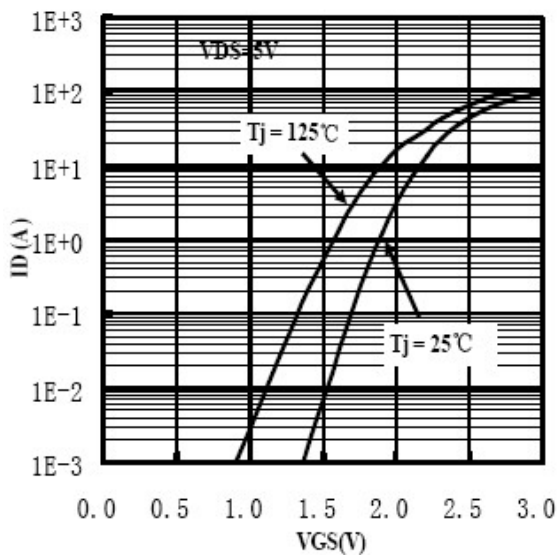

**Figure 4. Gate Threshold Voltage Characteristics**

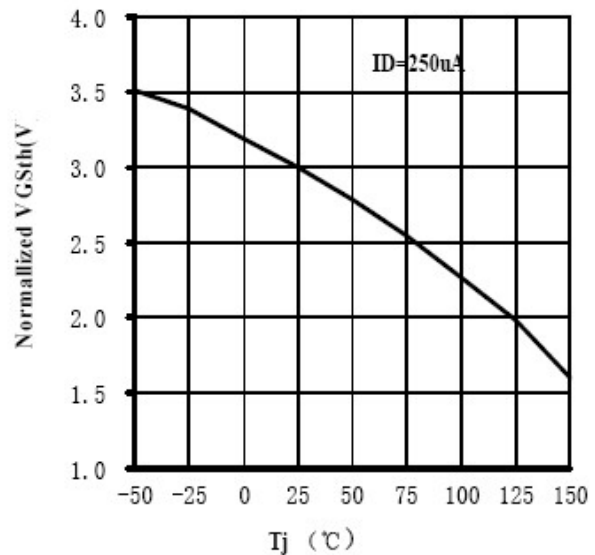

Figure 5. Rdson vs. Drain Current Characteristics

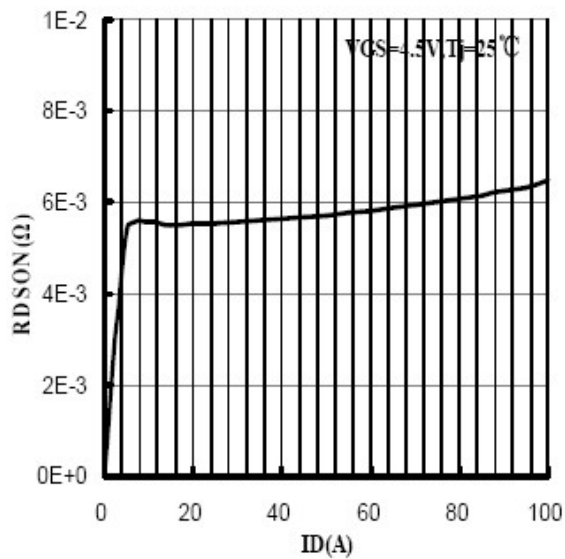

Figure 6. Rdson vs. Junction Tem Characteristics

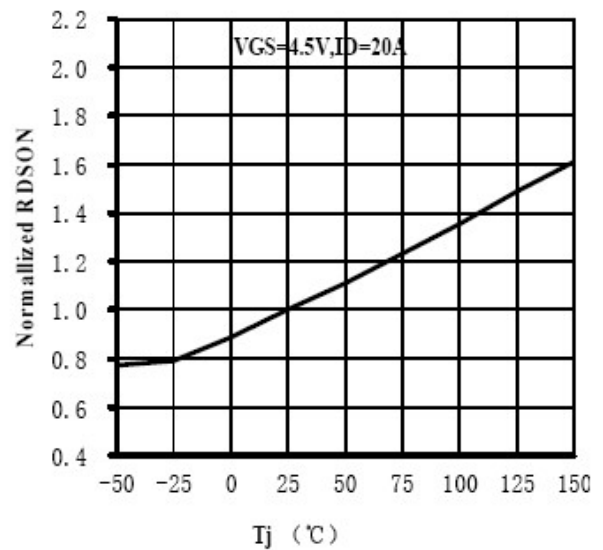

Figure 7. Rdson vs. VGS Characteristics

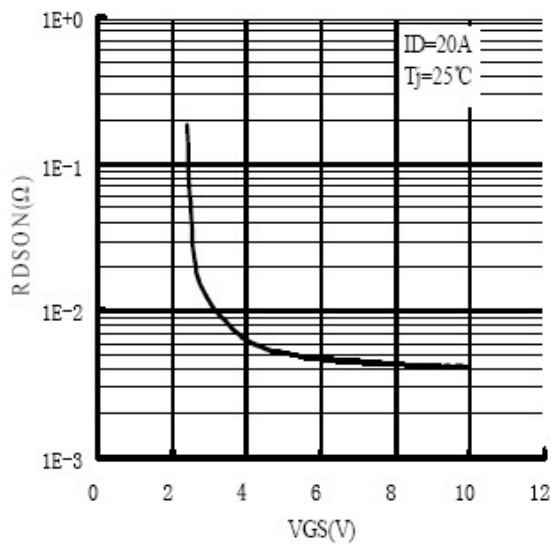

Figure 8. IS vs. VSD Characteristics

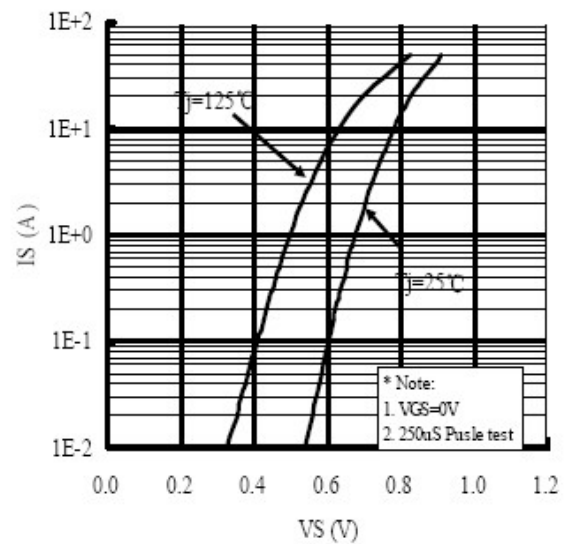

Figure 9. Gate Charge Characteristics

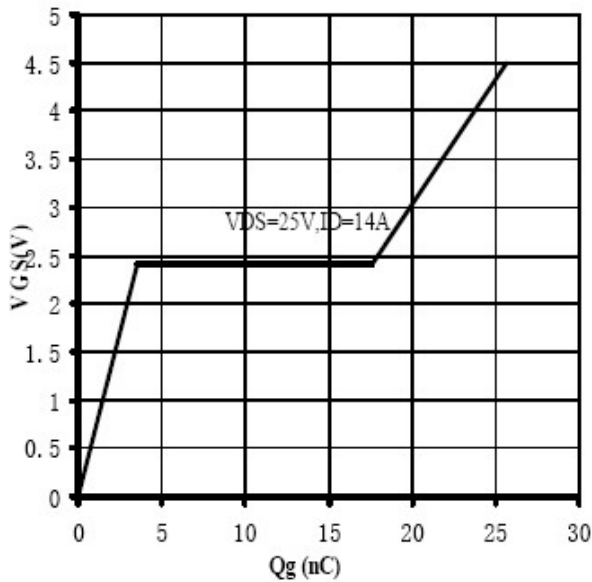

Figure 10. Capacitance Characteristics

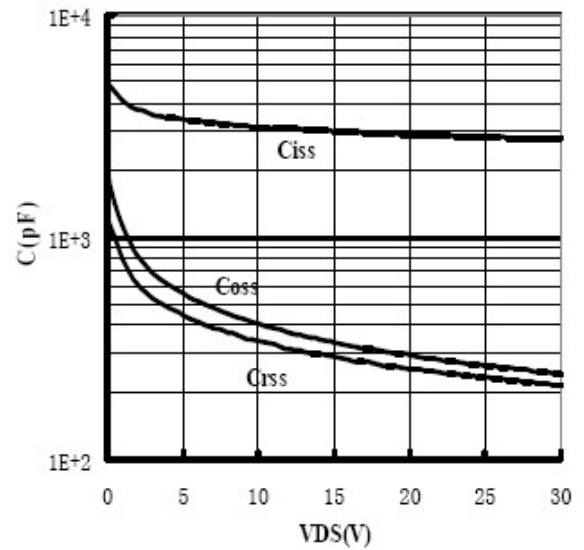
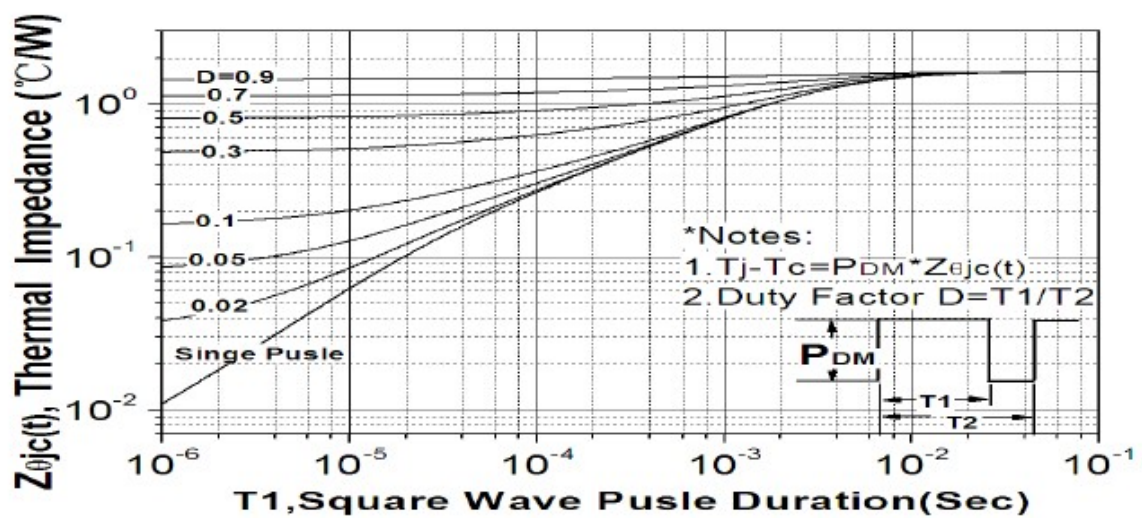
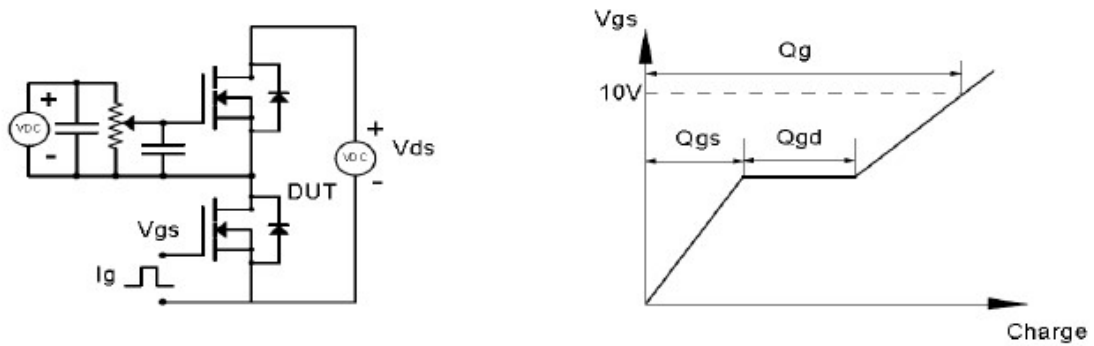

Figure 11. Thermal Resistance Characteristics



Gate Charge Test Circuit & Waveform



Resistive Switching Test Circuit & Waveforms

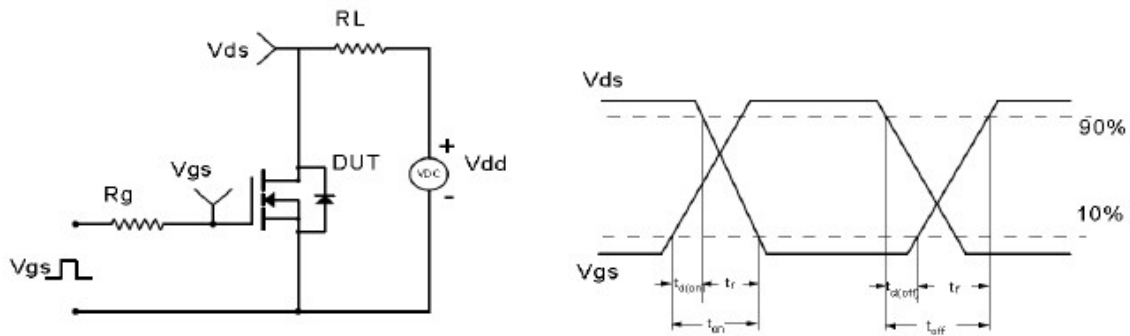

Unclamped Inductive Switching (UIS) Test Circuit & Waveforms

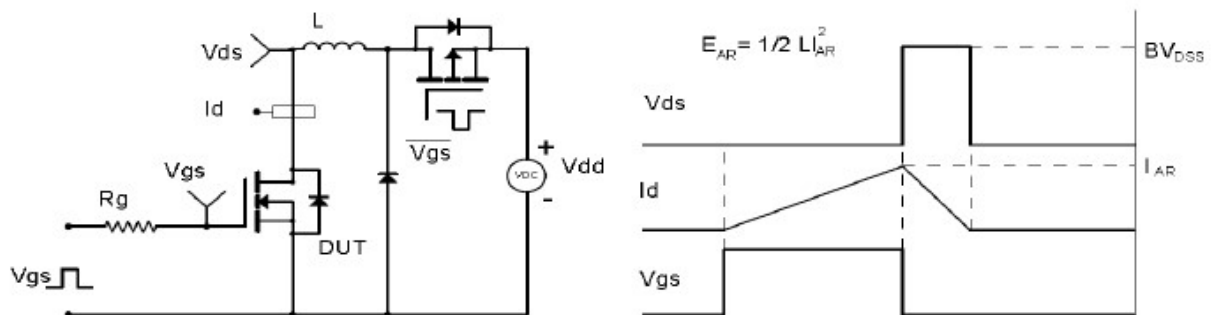

Diode Recovery Test Circuit & Waveforms

