

• General Description

The AGM216ME combines advanced trench MOSFET technology with a low resistance package to provide extremely low $R_{DS(ON)}$.

This device is ideal for load switch and battery protection applications.

• Features

- Advance high cell density Trench technology
- Low $R_{DS(ON)}$ to minimize conductive loss
- Low Gate Charge for fast switching
- Low Thermal resistance
- 100% Avalanche tested
- 100% DVDS tested

• Application

- MB/VGA Vcore
- SMPS 2nd Synchronous Rectifier
- POL application
- BLDC Motor driver

Product Summary

BVDSS	RDSON	ID
20V	21mΩ	3.3A
-20V	27.5mΩ	-5.6A

SOT23-6L Pin Configuration

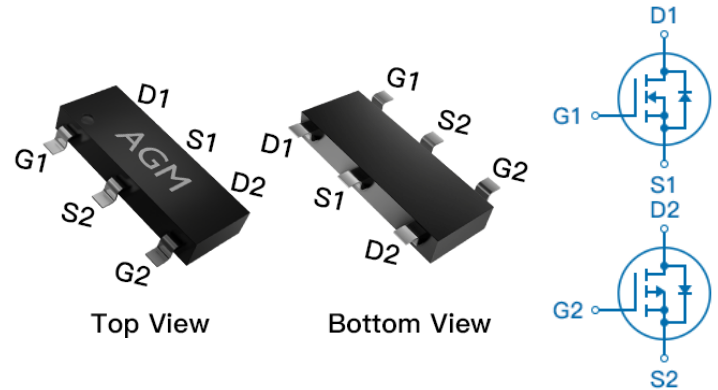

Package Marking and Ordering Information

Device Marking	Device	Device Package	Reel Size	Tape width	Quantity
AGM216ME	AGM216ME	SOT23-6L	178mm	8mm	3000

Table 1. Absolute Maximum Ratings (TA=25°C)

Symbol	Parameter	Rating		Units
		N-Ch	P-Ch	
V_{DS}	Drain-Source Voltage ($V_{GS}=0V$)	20	-20	V
V_{GS}	Gate-Source Voltage ($V_{DS}=0V$)	±12	±10	V
I_D	Drain Current-Continuous(TA=25°C) (Note 1)	3.3	-5.6	A
	Drain Current-Continuous(TA=100°C)	2.1	-3.7	A
IDM (pluse)	Drain Current-Pulsed (Note 2)	13.2	-22.4	A
P_D	Total Power Dissipation(TA=25°C)	1.25	1.25	W
EAS	Avalanche energy (Note 3)	25	16	mJ
TJ,TSTG	Operating Junction and Storage Temperature Range	-55 To 150	-55 To 150	°C

Table 2. Thermal Characteristic

Symbol	Parameter	Typ	Max	Unit
$R_{\theta Ja}$	Thermal Resistance Junction-ambient (Steady State) ¹	---	100	°C/W

Table 3. N- Channel Electrical Characteristics (T_J=25°C unless otherwise noted)

Symbol	Parameter	Conditions	Min	Typ	Max	Unit
On/Off States						
BVDSS	Drain-Source Breakdown Voltage	VGS=0V ID=250μA	20	--	--	V
IDSS	Zero Gate Voltage Drain Current	VDS=19.5V,VGS=0V	--	--	1	μA
IGSS	Gate-Body Leakage Current	VGS=±12V,VDS=0V	--	--	±100	nA
VGS(th)	Gate Threshold Voltage	VDS=VGS,ID=250μA	0.5	0.7	0.9	V
gFS	Forward Transconductance	VDS=5V,ID=4A	--	3	--	S
RDS(on)	Drain-Source On-State Resistance	VGS=4.5V, ID=5A	--	21	24	mΩ
		VGS=2.5V, ID=4A	--	26	30	mΩ
Dynamic Characteristics						
Ciss	Input Capacitance	VDS=10V,VGS=0V, F=1MHZ	--	355	--	pF
Coss	Output Capacitance		--	68	--	pF
Crss	Reverse Transfer Capacitance		--	59	--	pF
Rg	Gate resistance	VGS=0V, VDS=0V,f=1.0MHz	--	--	--	Ω
Switching Times						
td(on)	Turn-on Delay Time	VGS=4.5V,VDS=10V ID=4A, RGEN=3Ω	--	15	--	nS
tr	Turn-on Rise Time		--	49	--	nS
td(off)	Turn-Off Delay Time		--	19	--	nS
tf	Turn-Off Fall Time		--	16	--	nS
Qg	Total Gate Charge	VGS=4.5V, VDS=10V, ID=2A	--	5.5	--	nC
Qgs	Gate-Source Charge		--	0.6	--	nC
Qgd	Gate-Drain Charge		--	0.9	--	nC
Source-Drain Diode Characteristics						
ISD	Source-Drain Current(Body Diode)		--	--	3.3	A
VSD	Forward on Voltage	VGS=0V,IS=5A	--	--	1.2	V
trr	Reverse Recovery Time	IF=5A , dl/dt=100A/μs ,	--	--	--	ns
Qrr	Reverse Recovery Charge	TJ=25°C	--	--	--	nc

Notes 1.The maximum current rating is package limited.

Notes 2.Repetitive Rating: Pulse width limited by maximum junction temperature

Notes 3.EAS condition: T_J=25°C, VDD=15V, Vgs=10V, ID=10A, L=0.5mH, RG=25ohm

Table 3. P-Channel Electrical Characteristics (T_J=25°C unless otherwise noted)

Symbol	Parameter	Conditions	Min	Typ	Max	Unit
On/Off States						
BVDSS	Drain-Source Breakdown Voltage	VGS=0V ID=-250μA	-20	--	--	V
IDSS	Zero Gate Voltage Drain Current	VDS=-20V,VGS=0V	--	--	-1	μA
IGSS	Gate-Body Leakage Current	VGS=±10V,VDS=0V	--	--	±100	nA
VGS(th)	Gate Threshold Voltage	VDS=VGS,ID=-250μA	-0.4	-0.6	-1.0	V
gFS	Forward Transconductance	VDS=-5V,ID=-3A	--	3	--	S
RDS(on)	Drain-Source On-State Resistance	VGS=-4.5V, ID=-4A	--	27.5	32	mΩ
		VGS=-2.5V, ID=-3A	--	37	45	mΩ
Dynamic Characteristics						
Ciss	Input Capacitance	VDS=-10V,VGS=0V, F=1MHZ	--	671	--	pF
Coss	Output Capacitance		--	115	--	pF
Crss	Reverse Transfer Capacitance		--	110	--	pF
Rg	Gate resistance	VGS=0V, VDS=-0V,f=1.0MHz	--	--	--	Ω
Switching Times						
td(on)	Turn-on Delay Time	VGS=-10V,VDS=-10V, ID=-5A,RGEN=3Ω	--	15	--	nS
tr	Turn-on Rise Time		--	35	--	nS
td(off)	Turn-Off Delay Time		--	30	--	nS
tf	Turn-Off Fall Time		--	14	--	nS
Qg	Total Gate Charge	VGS=-10V, VDS=-10V, ID=-5A	--	18	--	nC
Qgs	Gate-Source Charge		--	1.5	--	nC
Qgd	Gate-Drain Charge		--	2.5	--	nC
Source-Drain Diode Characteristics						
ISD	Source-Drain Current(Body Diode)		--	--	-5.6	A
VSD	Forward on Voltage	VGS=0V,IS=-4A	--	--	-1.2	V
trr	Reverse Recovery Time	IF=-4A , dI/dt=100A/μs ,TJ=25°C	--	--	--	ns
Qrr	Reverse Recovery Charge		--	--	--	nc

Notes 1.The maximum current rating is package limited.

Notes 2.Repetitive Rating: Pulse width limited by maximum junction temperature

Notes 3.EAS condition: T_J=25°C ,VDD=-15V,Vgs=-10V,ID=-8A, L=0.5mH,RG=25ohm

N-Channel Typical Characteristics

Test Circuit & Waveform

Gate Charge Test Circuit & Waveform

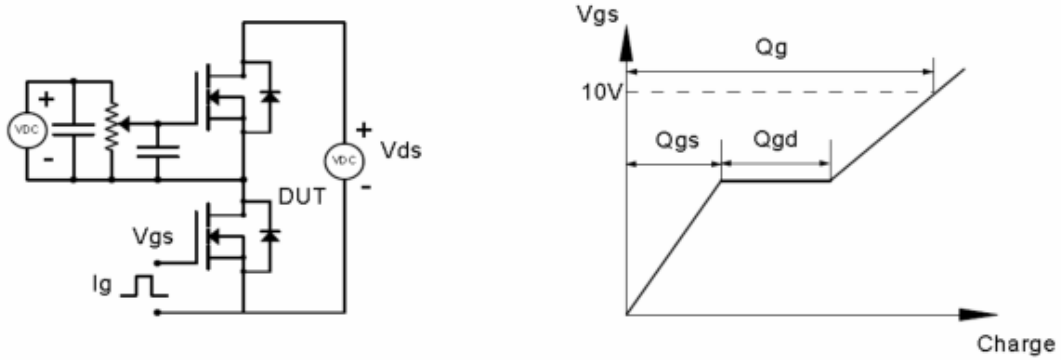

Resistive Switching Test Circuit & Waveforms

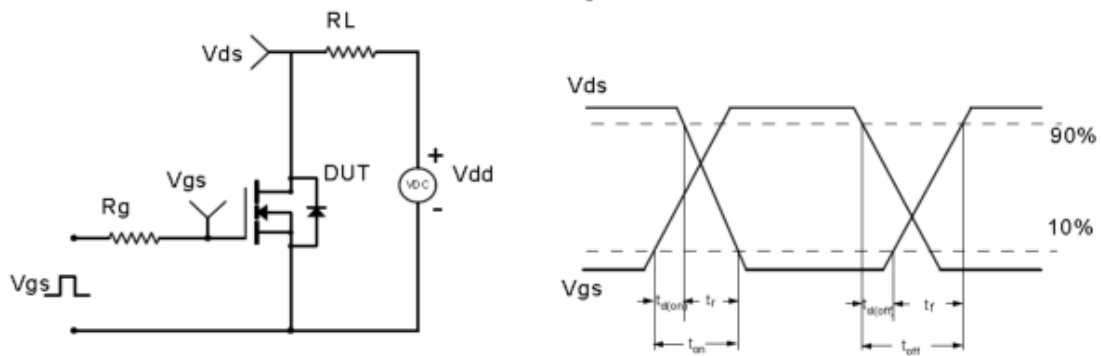

Unclamped Inductive Switching (UIS) Test Circuit & Waveforms

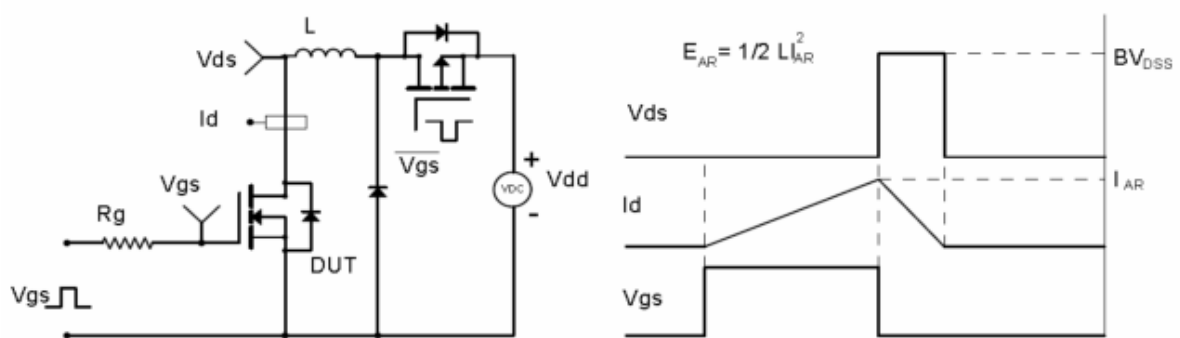

Diode Recovery Test Circuit & Waveforms

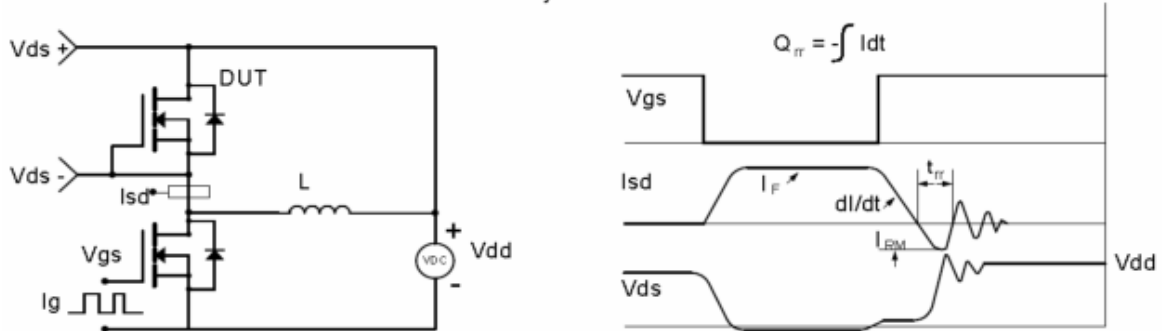

Figure 1: Output Characteristics

Figure 2: Typical Transfer Characteristics

Figure 3: On-resistance vs. Drain Current

Figure 4: Body Diode Characteristics

Figure 5: Gate Charge Characteristics

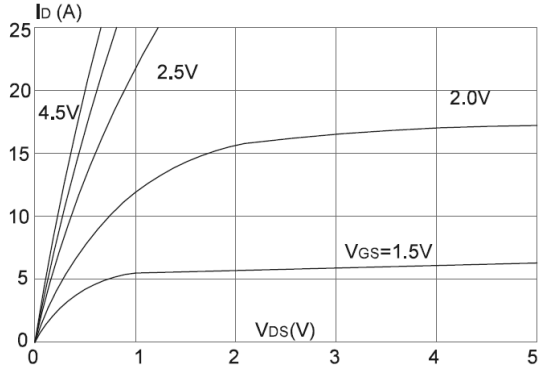
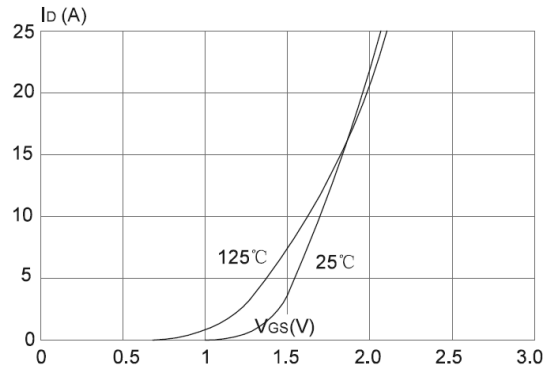
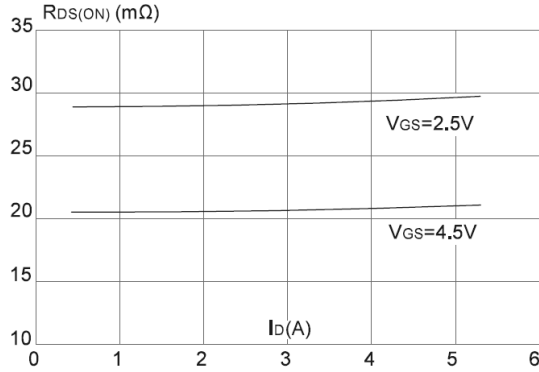
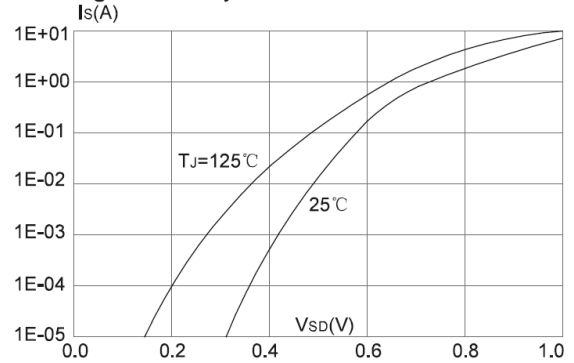
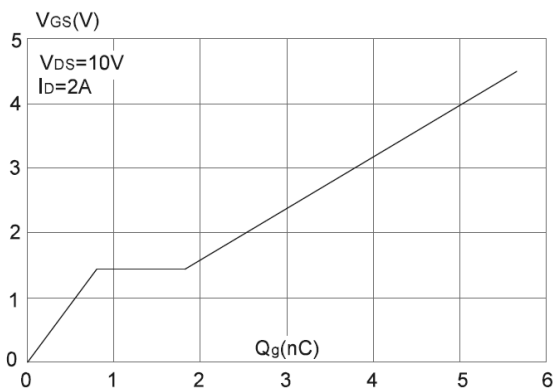
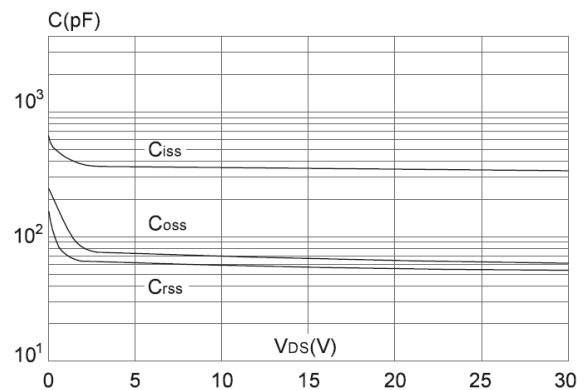
Figure 6: Capacitance Characteristics

Figure 7: Normalized Breakdown Voltage vs. Junction Temperature

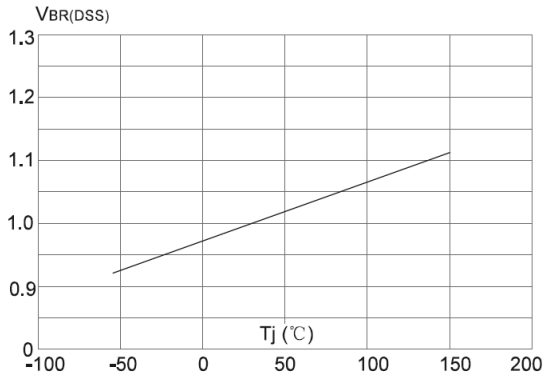

Figure 8: Normalized on Resistance vs. Junction Temperature

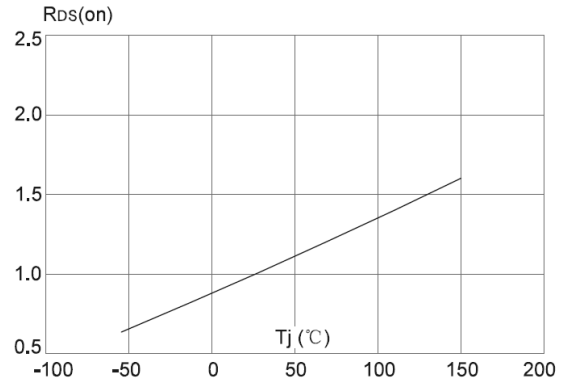

Fig.9 Maximum Continuous Drain Current VS. Ambient Temperature

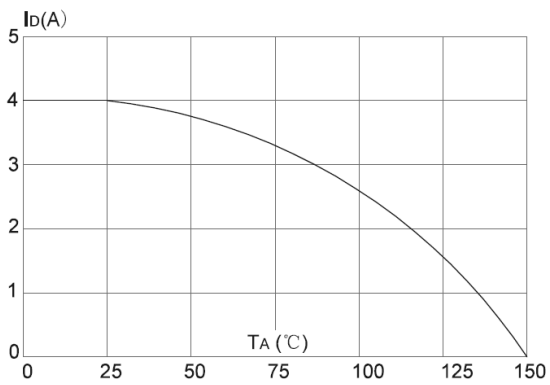

Fig.10 Maximum Safe Operating Area

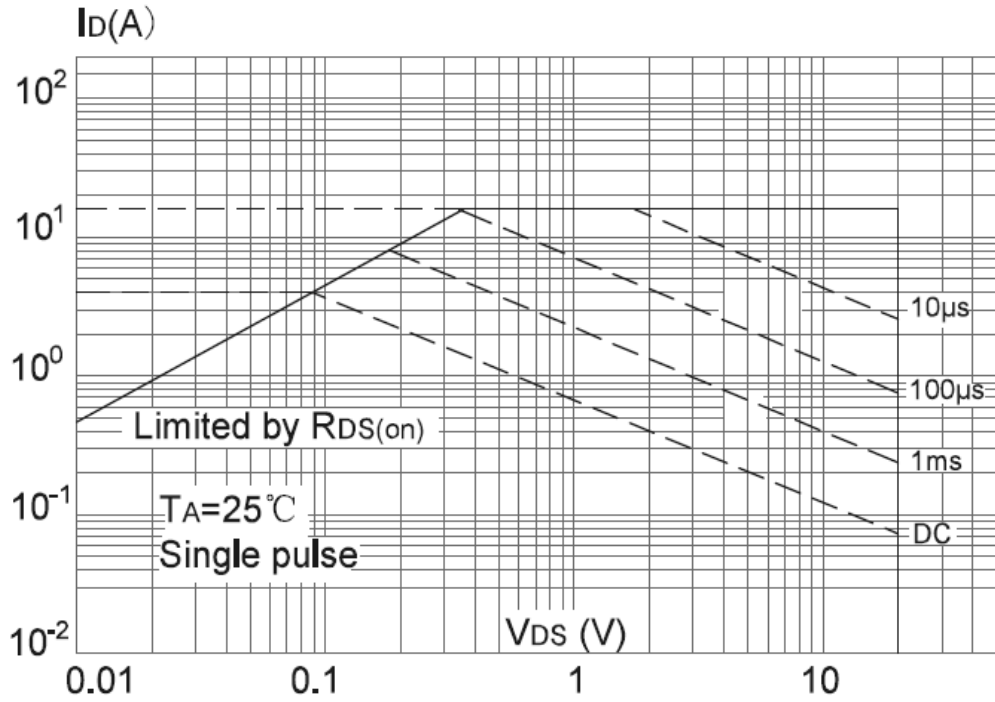
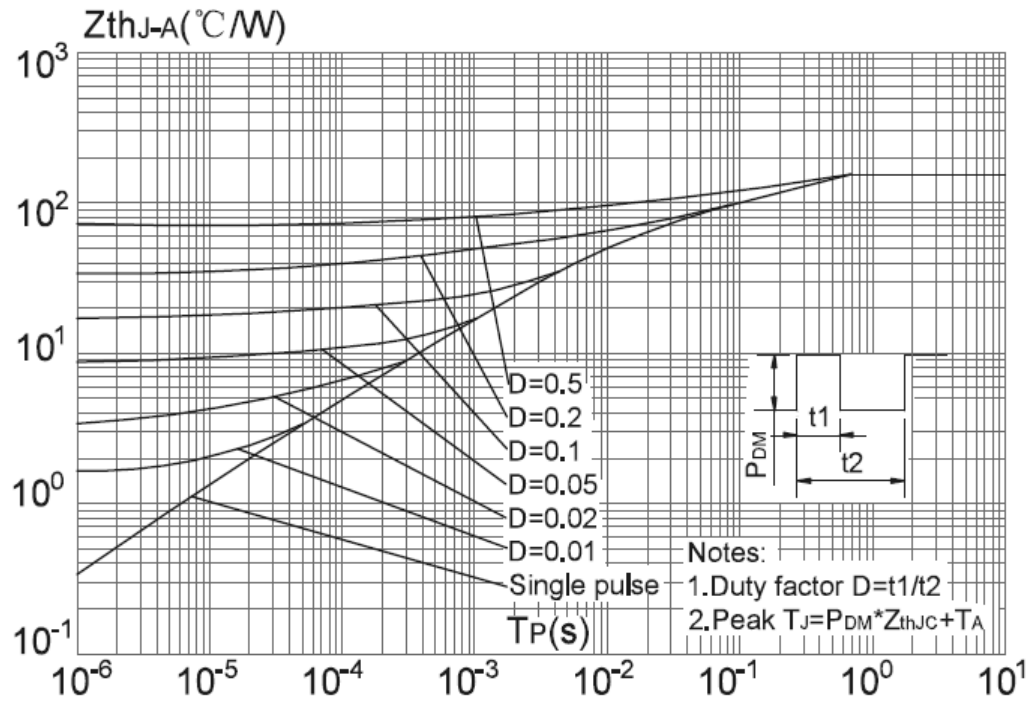
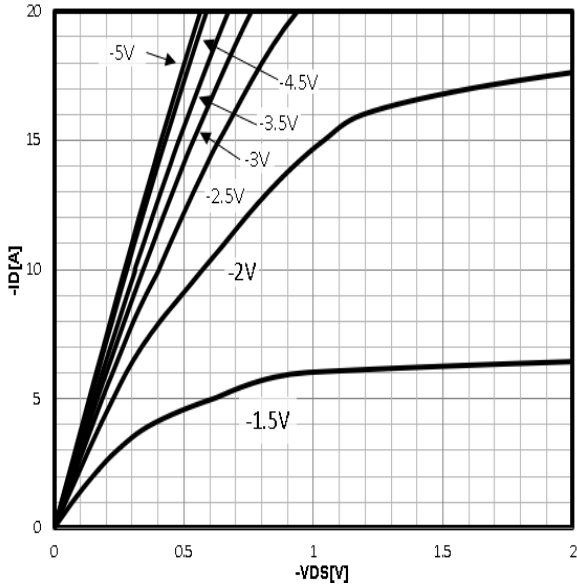

Fig. 11 Maximum Effective Transient Thermal Impedance , Junction-to-Ambient



P-Channel Typical Characteristics Curve:

Typ. output characteristics
 $I_D = f(V_{DS})$



Typ. drain-source on resistance
 $R_{DS(on)} = f(I_D)$

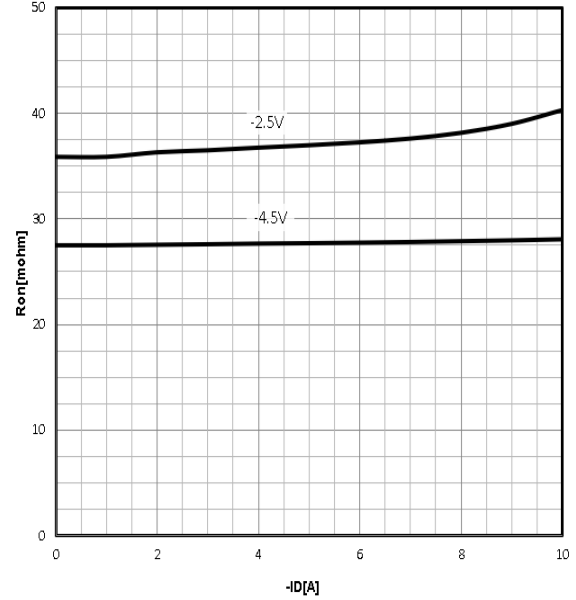

Typ. transfer characteristics
 $I_D = f(V_{GS})$

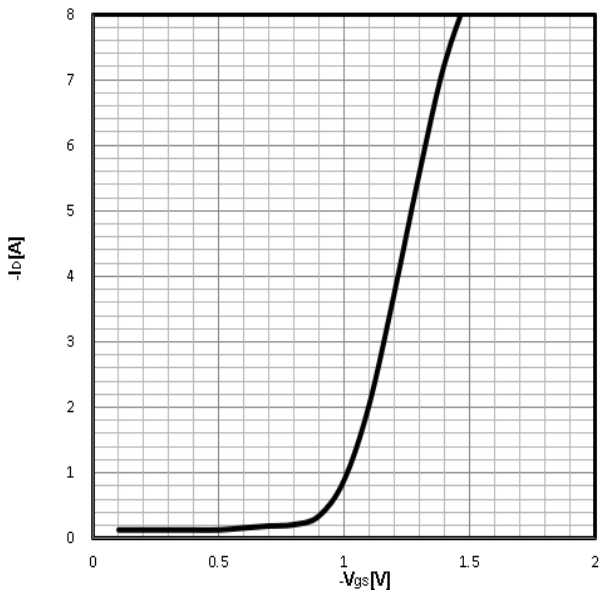

Drain-source on-state resistance
 $R_{DS(on)} = f(T_j); I_D = -4A; V_{GS} = -4.5V$

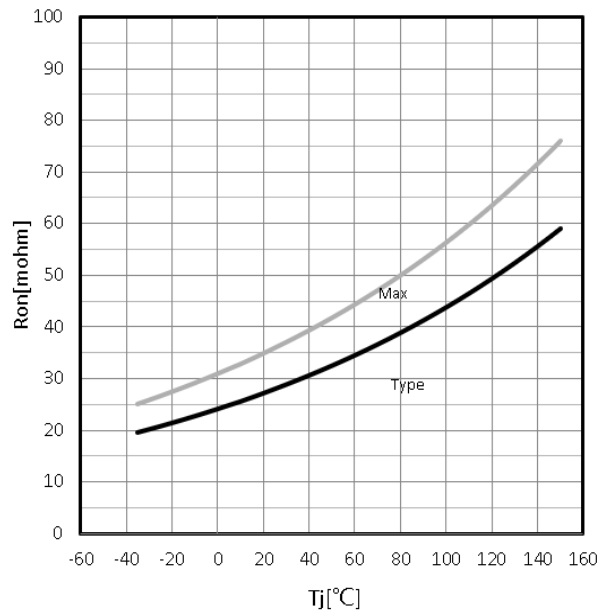

Gate Threshold Voltage
 $-V_{TH}=f(T_j); I_D=-250\mu A$

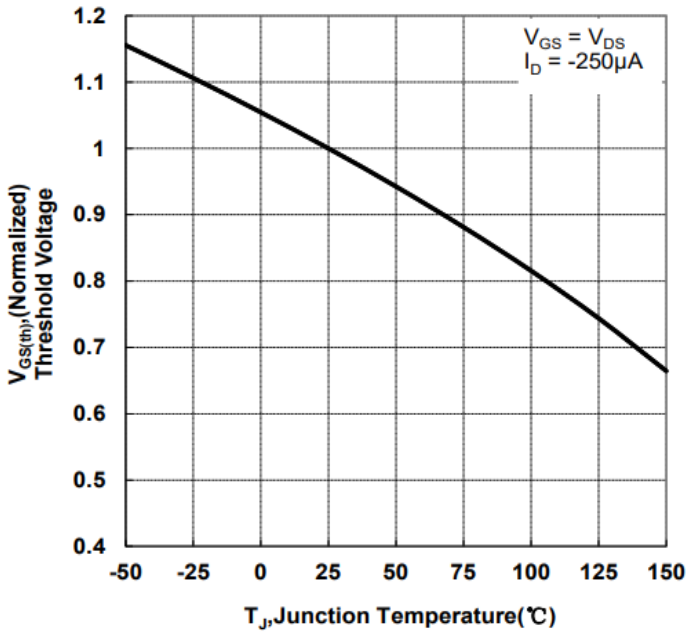

Drain-source breakdown voltage
 $V_{BR(DSS)}=f(T_j); I_D=-250\mu A$

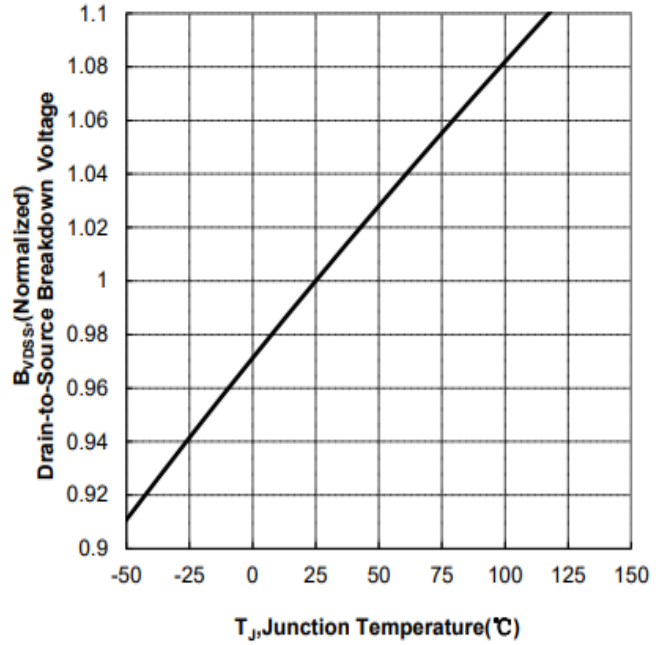

Typ. gate charge
 $V_{GS}=f(Q_{gate}); I_D=-5A$

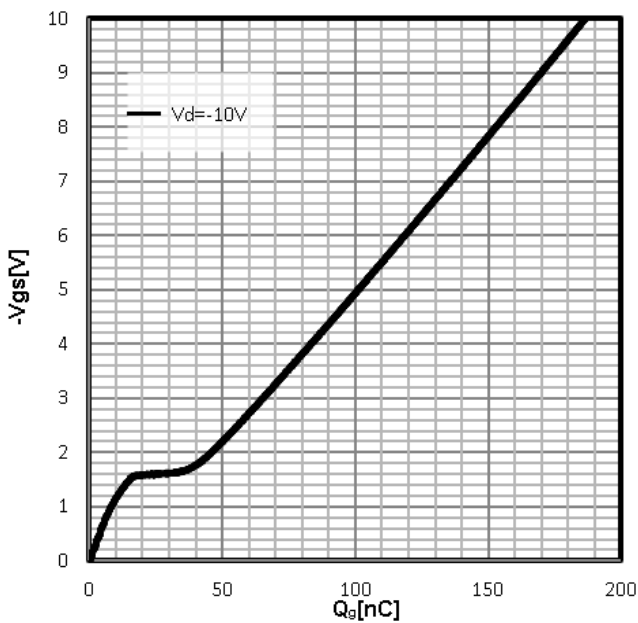

Typ. capacitances
 $C=f(V_{DS}); V_{GS}=0V; f=1MHz$

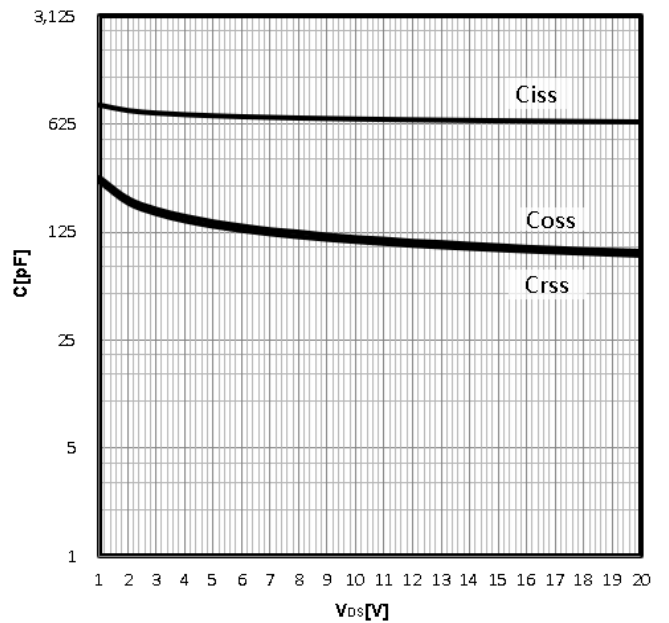

Power Dissipation

$P_{tot}=f(T_C)$

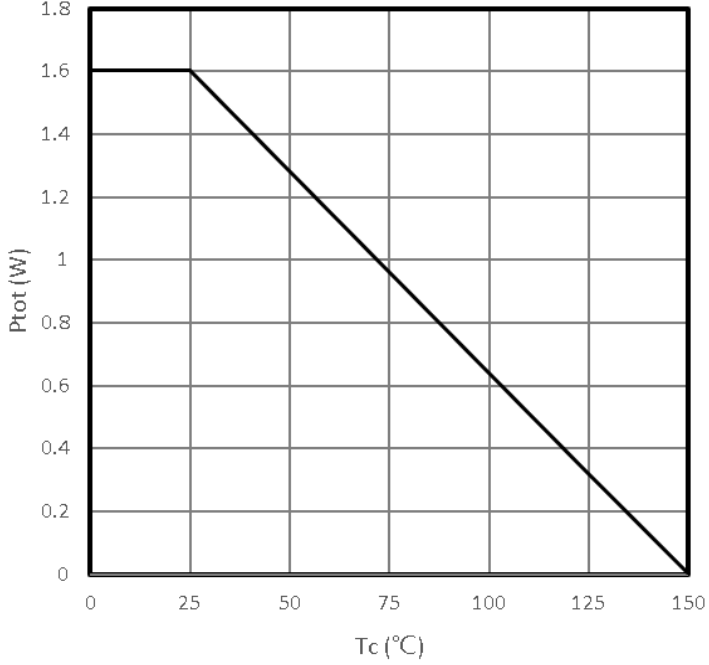

Maximum Drain Current

$-I_D=f(T_C)$

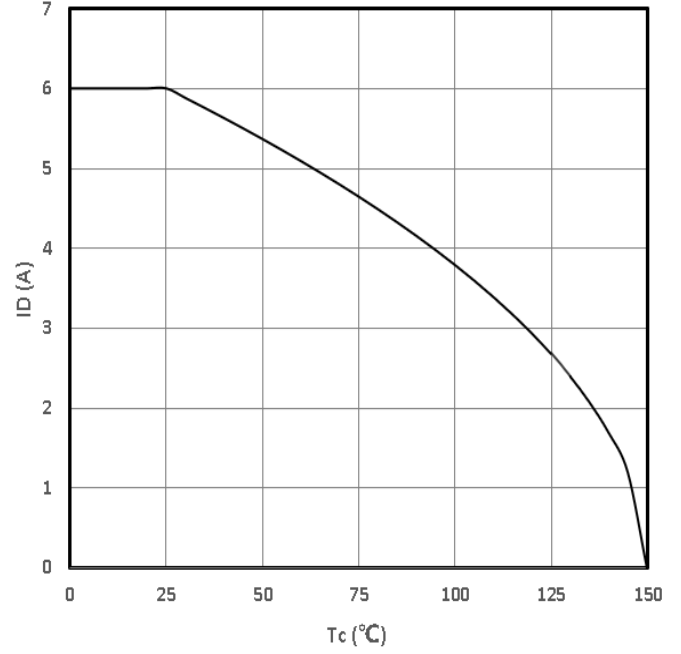

Safe operating area

$-I_D=f(-V_{DS})$

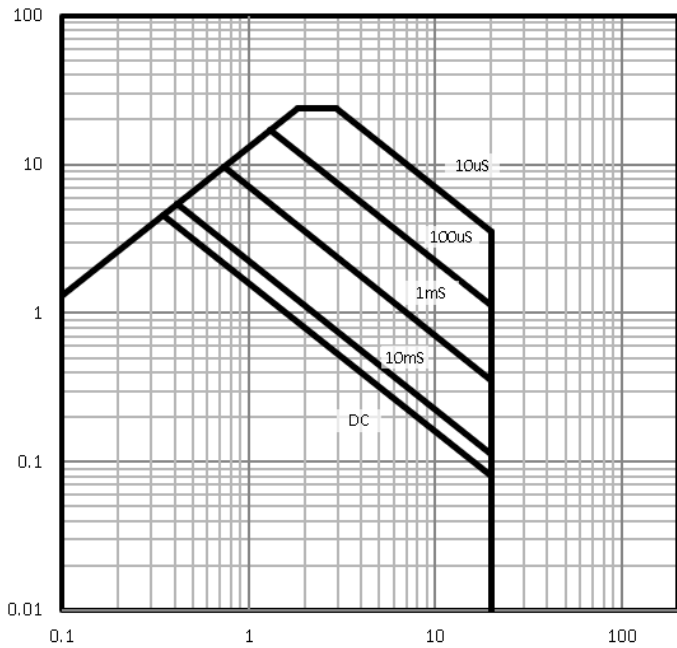

Body Diode Forward Voltage Variation

$-I_F=f(-V_{DS})$

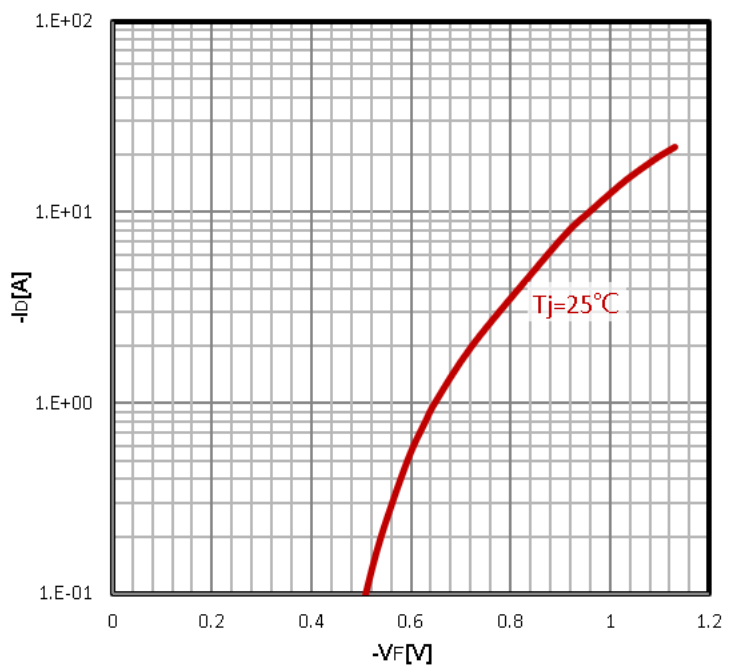

Max. transient thermal impedance

$$Z_{thJC} = f(t_p)$$

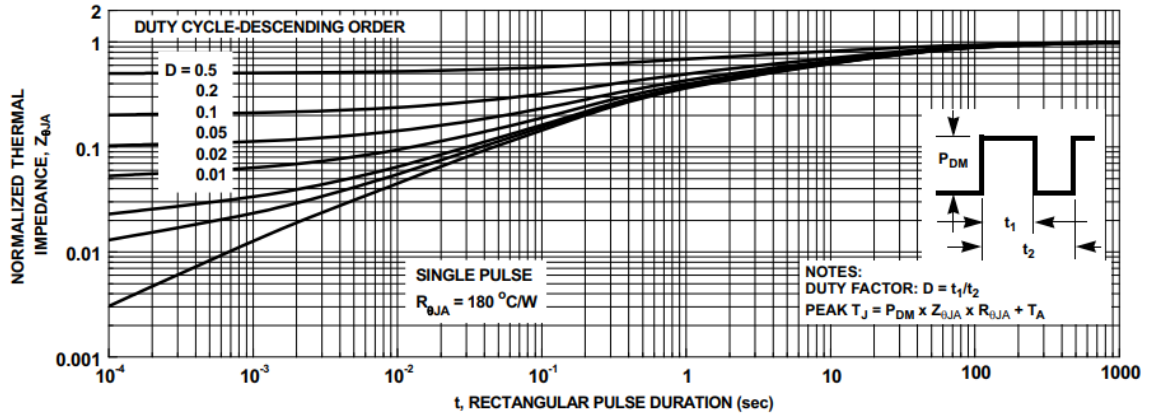

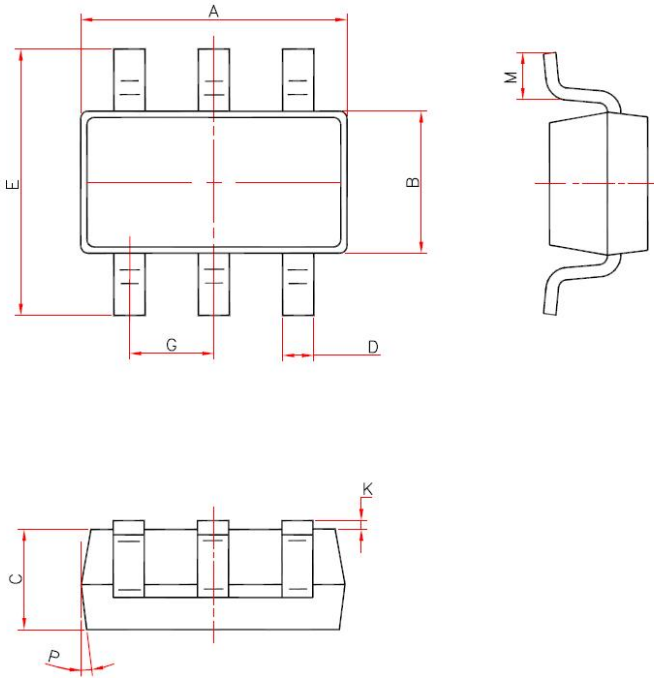
Package Outline Data SOT-23-6

DIM	MILLIMETERS
A	2.82~3.02
B	1.60 ± 0.10
C	1.10 ± 0.05
D	0.40 ± 0.10
E	2.65~2.95
G	0.95typ
K	0.00~0.10
M	0.20MIN
P	9 ± 2°

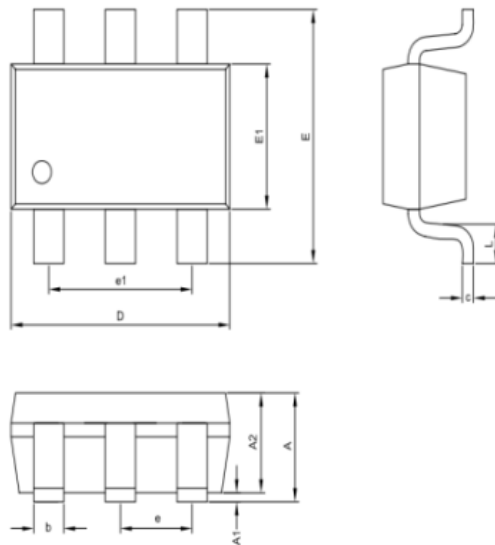

SOT23-6 Package Outline			
Symbol	Dim in mm		
	Min	Nor	Max
A	1.00	1.10	1.45
A1	0.05	0.10	0.15
A2	1.0	1.1	1.3
D	2.8	2.9	3.1
E	2.65	2.8	2.95
E1	1.5	1.6	1.7
c	0.10	0.15	0.25
b	0.3	0.4	0.5
e	0.95BSC		
e1	1.9BSC		
L	0.300	0.450	0.600

封装形式	站高		脚宽		跨度		脚厚		水口		长引脚		胶厚		毛刺
	Min	max	min	max	min	max	min	max	min	max	min	max	min	max	
SOT23-6	0.05	0.15	0.30	0.50	2.65	2.95	0.10	0.25	0.00	0.10	0.00	0.15	1.0	1.3	0.00-0.10

Disclaimer:

The information provided in this document is believed to be accurate and reliable. however, Shenzhen Core Control Electronics Technology Co., Ltd. does not assume any responsibility for the following consequences. Do not consider the use of such information or use beyond its scope.

The information mentioned in this document may be changed at any time without notice.

The products and information provided in this document do not infringe patents. Shenzhen Core Control Electronics Technology Co., Ltd. assumes no responsibility for any infringement of any other rights of third parties. The result of using such products and information.

This document is the third version issued on Dec.20th, 2023. This document replaces all previously provided information.

 It is a registered trademark of Shenzhen Core Control Electronics Technology Co., Ltd.

Copyright © 2017 Shenzhen Core Control Electronics Technology Co., Ltd. all rights reserved.