

THIS DRAWING IS THE PROPERTY OF ANALOG DEVICES INC. IT IS NOT TO BE REPRODUCED OR COPIED, IN WHOLE OR IN PART, OR USED IN FURNISHING INFORMATION TO OTHERS, OR FOR ANY OTHER PURPOSE DETRIMENTAL TO THE INTERESTS OF ANALOG DEVICES. THE EQUIPMENT SHOWN HEREON MAY BE PROTECTED BY PATENTS OWNED OR CONTROLLED BY ANALOG DEVICES.

RELAY CONTROL CHART

CONTROL	CODE	DEVICE	FUNCTION	CONNECTOR

JUMPER TABLE		
JP#	ON	OFF
1		
2		
3		
4		
5		

* SEE ASSEMBLY INSTRUCTIONS

REVISIONS			
REV	DESCRIPTION	DATE	APPROVED
A	INITIAL RELEASE	10MAR17	G.ARINUELO
B	CHANGES AS PER ECR-074043	08DEC17	G.ARINUELO

CN-0409: LOW TO HIGH LEVEL WATER TURBIDITY MEASUREMENTS

P.O SPEC.	BK/BD SPEC.	SOCKET OEM	OEM PART#	HANDLER

TEMPLATE ENGINEER N/A	DATE	<h3>SCHEMATIC</h3> 			
HARDWARE SERVICES N/A			HW TYPE : Customer Evaluation Z		
HARDWARE SYSTEMS N/A			Product(s) : ADPD107 : ADP105		
TEST ENGINEER N/A			PACKAGE : N/A-lead N/A N/A-family : Pitch-pitch StyleVendor Style		
COMPONENT ENGINEER G. CELEDONIO	10MAR17		<User Define>		
TEST PROCESS N/A			<User Define>		
HARDWARE RELEASE R. AMARILLE	10MAR17	<User Define>			
DESIGNER M. RAMILO	10MAR17	MASTER PROJECT TEMPLATE TBD	TESTER TEMPLATE no_template	DRAWING NO. 02_045872	REV. B
PTD ENGINEER G. ARINUELO	10MAR17	UNLESS OTHERWISE SPECIFIED DIMENSIONS ARE IN INCHES TOLERANCES			SIZE D
CHECKER N/A		DECIMALS X.XX +0.010 X.XXX +0.005	FRACTIONS +1/32	ANGLES +2	SCALE 1:1
				CODE ID NO. CodeID	SHEET 1 OF 3

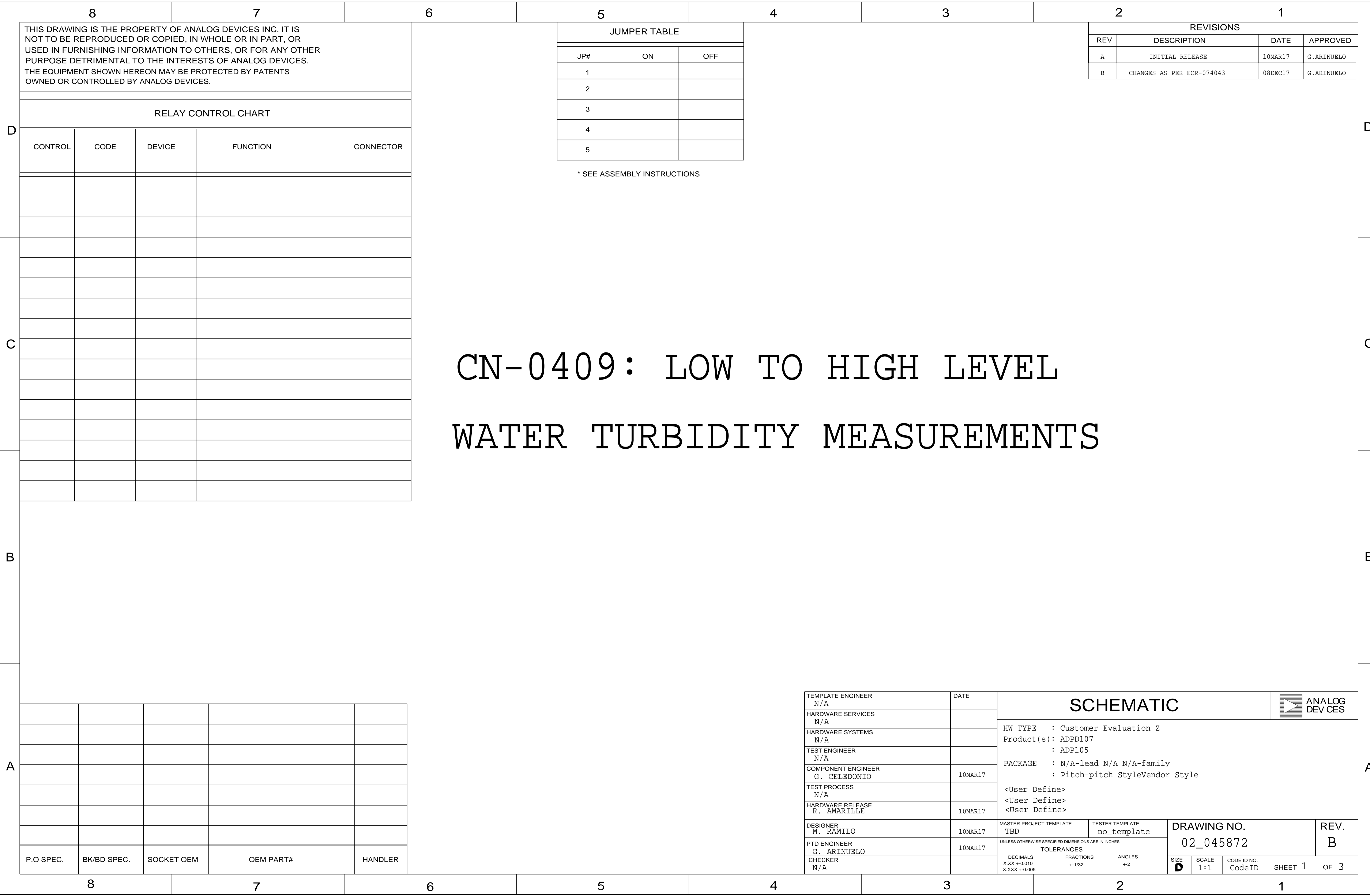

REVISIONS			
REV	DESCRIPTION	DATE	APPROVED

POWER SUPPLY

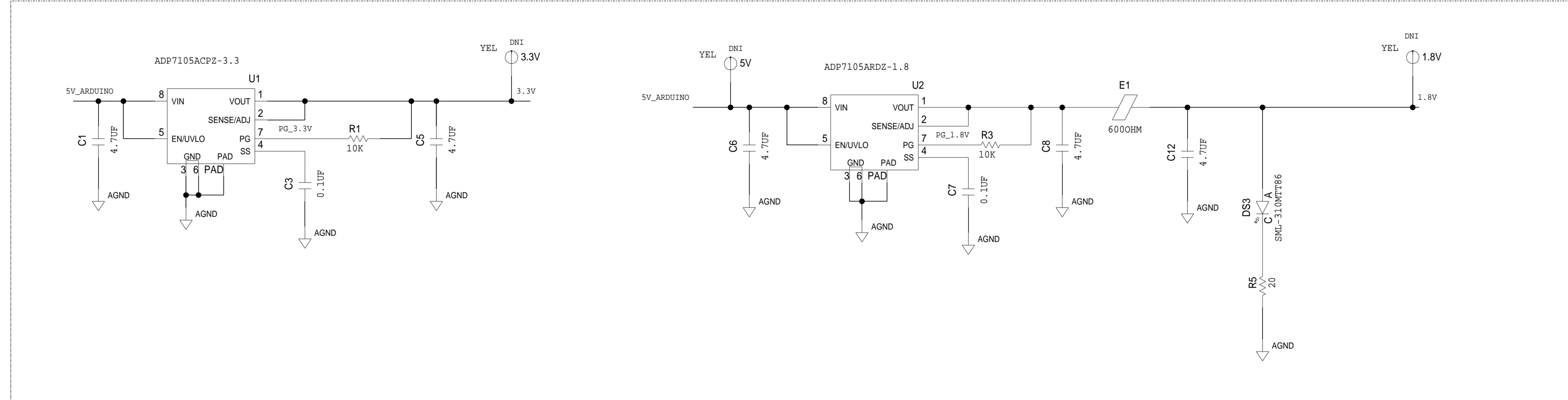

LED

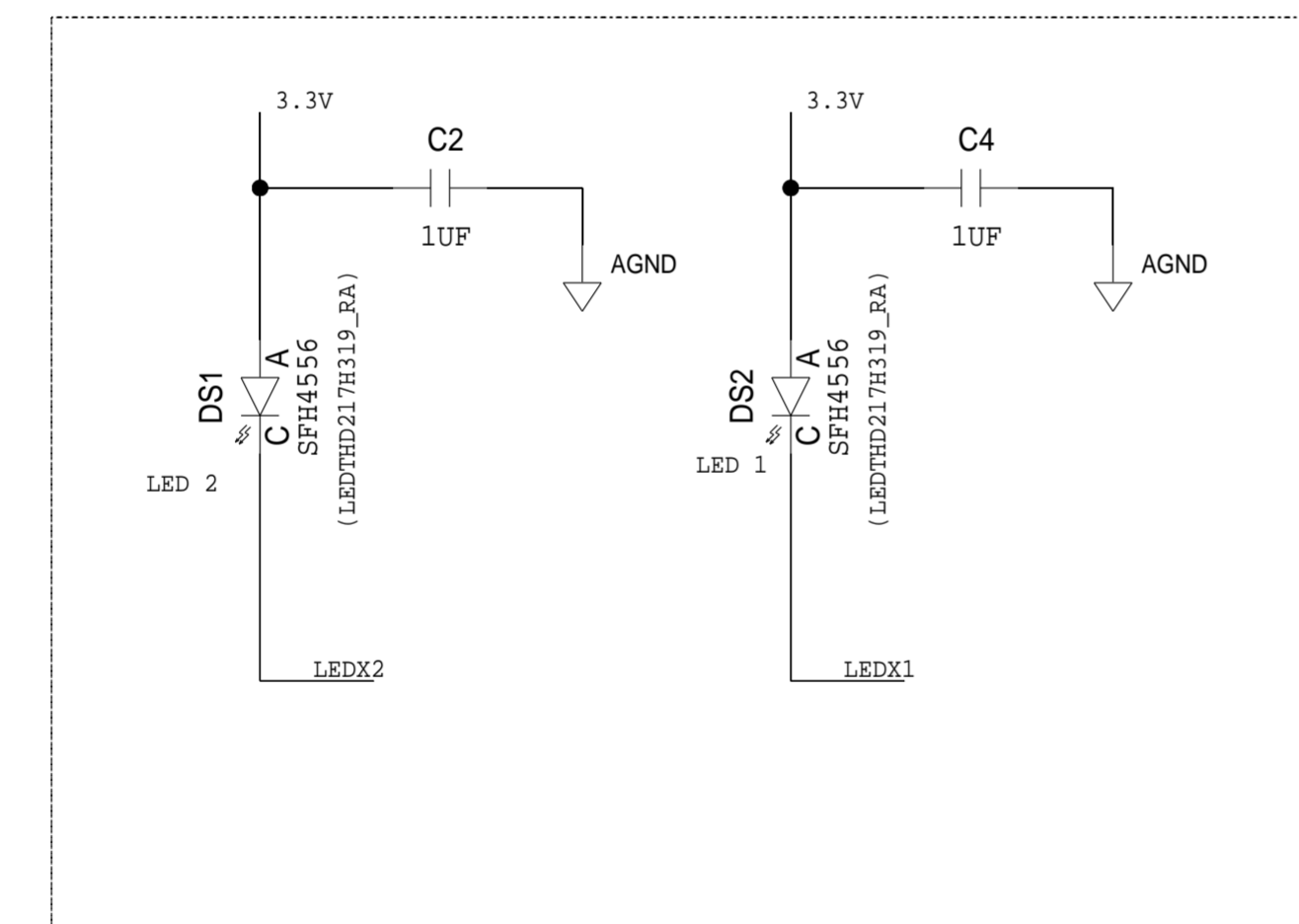

PHOTODIODE

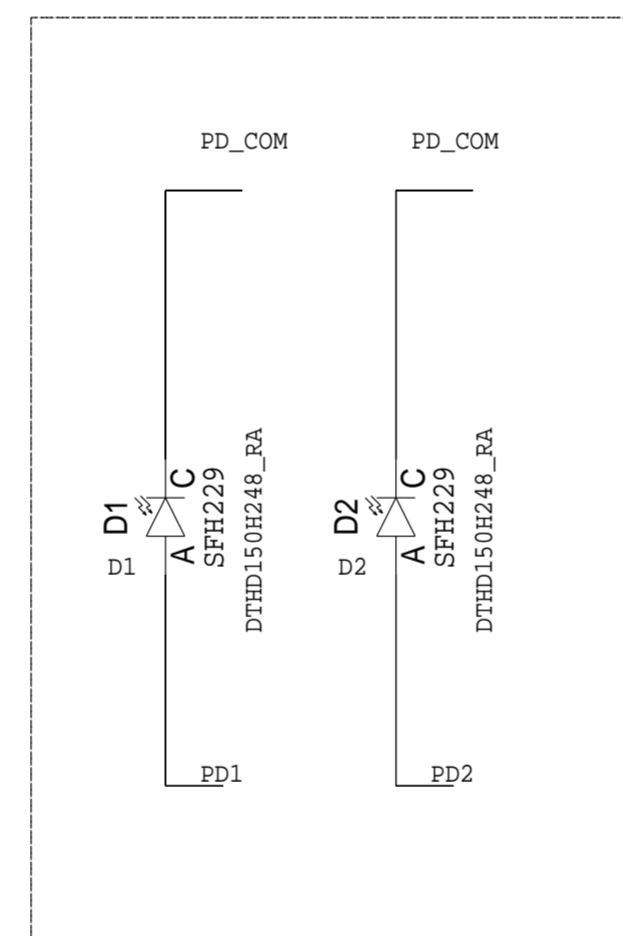

PHOTOMETRIC FRONTEND

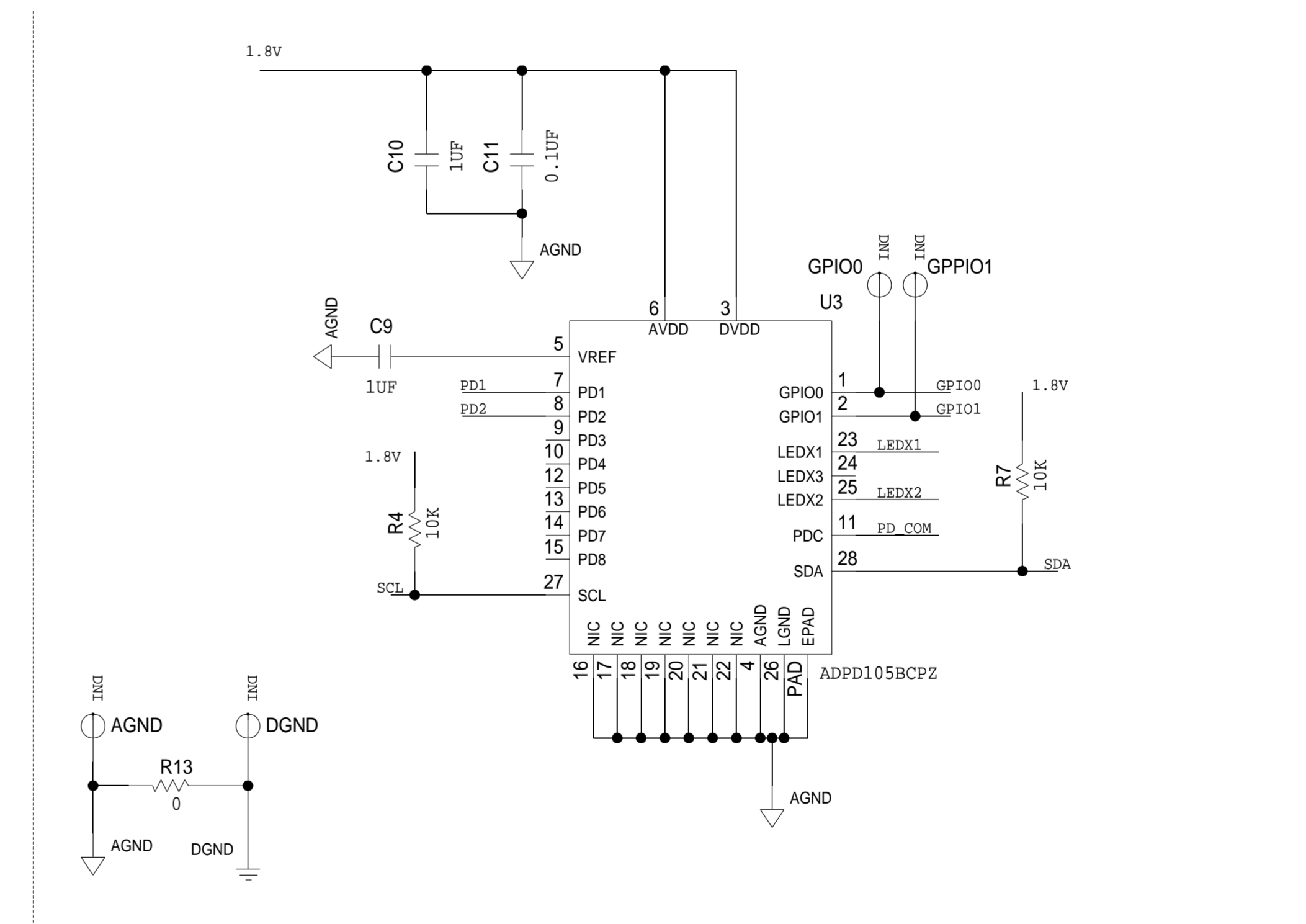

ANALOG DEVICES				SCHEMATIC			
<small>THIS DRAWING IS THE PROPERTY OF ANALOG DEVICES INC. IT IS NOT TO BE REPRODUCED OR COPIED, IN WHOLE OR IN PART, OR USED FOR ANY OTHER PURPOSE DETRIMENTAL TO THE INTERESTS OF ANALOG DEVICES. THE EQUIPMENT SHOWN HEREON MAY BE PROTECTED BY PATENTS OWNED OR CONTROLLED BY ANALOG DEVICES.</small>				HW TYPE : Customer Evaluation Z Product(s) : ADP107 : ADP105			
				DESIGN VIEW <DESIGN_VIEW>		DRAWING NO. 02_045872	
PTD ENGINEER G. ARINUELO		SIZE D		SCALE 1:1		SHEET 2 OF 3	

ARDUINO SHIED CONNECTOR

REVISIONS			
REV	DESCRIPTION	DATE	APPROVED

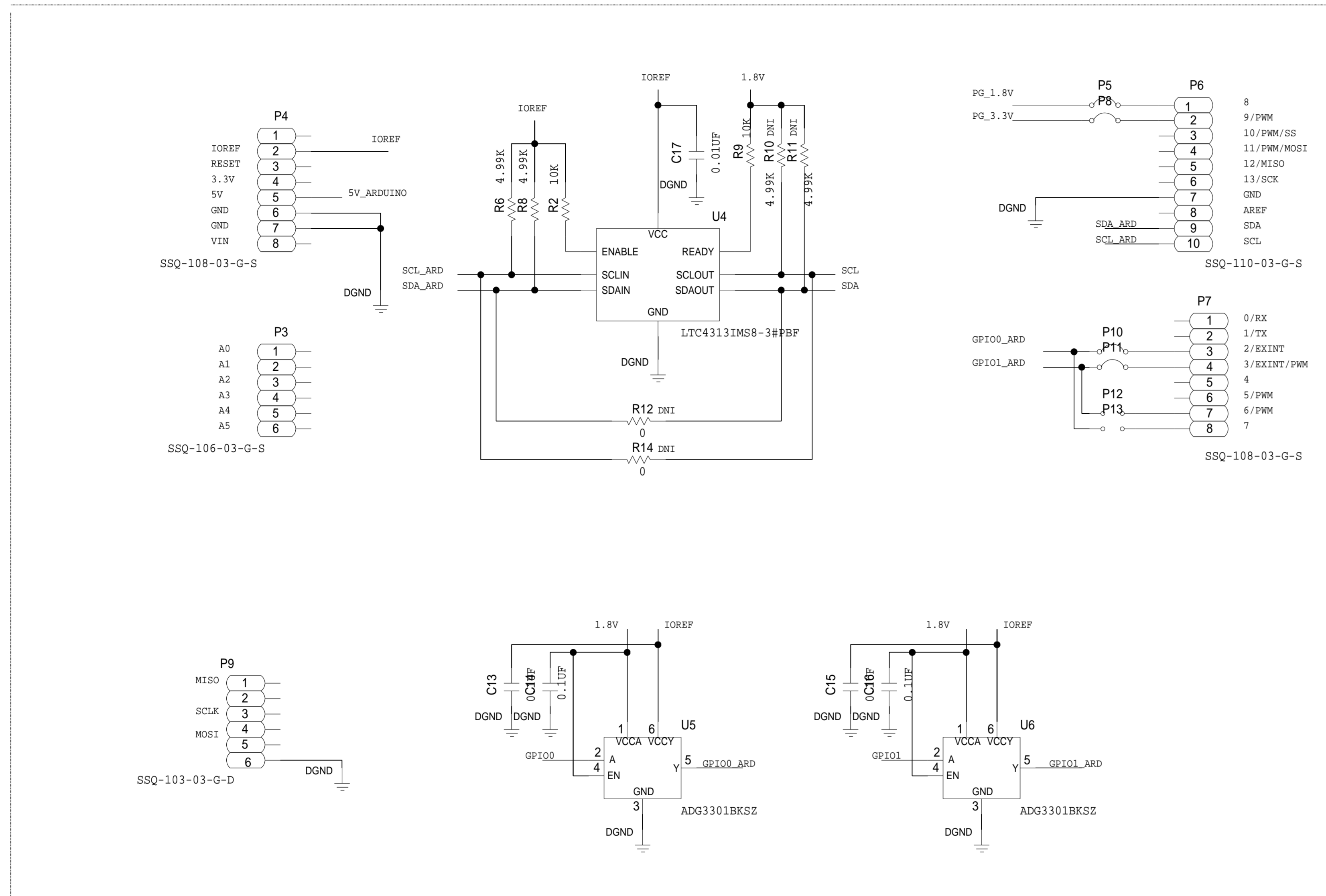

	SCHEMATIC		
	HW TYPE : Customer Evaluation Z Product(s): ADP107 : ADP105		
	DESIGN VIEW <DESIGN_VIEW>	DRAWING NO. 02_045872	REV B
	PTD ENGINEER G. ARINUELO	SIZE D	SCALE 1:1
		SHEET 3 OF 3	