

### GENERAL DESCRIPTION

The SGM2564A is a single load switch with reverse current protection function. The device can operate from 1V to 5.5V single supply and has the ability to drive up to 4A continuous current.

The device contains a 16mΩ low R<sub>ON</sub> N-MOSFET controlled by the ON pin. The small package and low R<sub>ON</sub> make the device very suitable for space limited, battery powered applications.

The device supports a wide input voltage range, which is suitable for many different voltage rails. The rise time is used to avoid inrush current.

The SGM2564A is available in a Green WLCSP-1.45×0.95-6B package.

### FEATURES

- **Input Voltage Range: 1V to 5.5V**
- **Maximum Continuous Current: 4A**
- **Low On-Resistance**
  - ◆ R<sub>ON</sub> = 16mΩ at V<sub>IN</sub> = 3.3V
  - ◆ R<sub>ON</sub> = 16mΩ at V<sub>IN</sub> = 1.8V
- **Low Shutdown Current: 170nA (TYP)**
- **Reverse Current Protection When Disabled**
- **Low Threshold 1.2V GPIO Control Input**
- **Bidirectional Power Supply for Power Zone Application**
- **Controlled Slew Rate to Avoid Inrush Current**
- **Available in a Green WLCSP-1.45×0.95-6B Package**

### APPLICATIONS

- Smartphone
- Notebook and Tablet Computer
- Solid State Drive (SSD)
- Set-Top Box and Residential Gateway
- Portable and Handheld Device

### TYPICAL APPLICATION

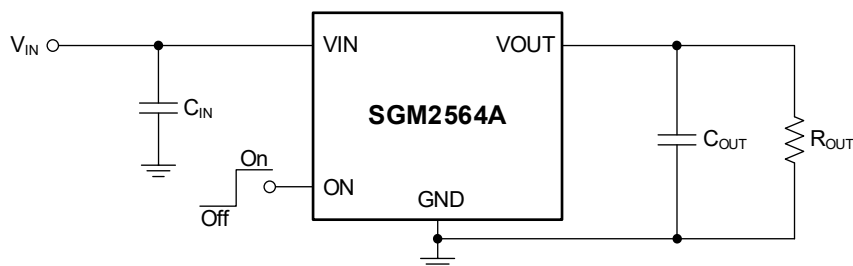

Figure 1. Typical Application Circuit

**PACKAGE/ORDERING INFORMATION**

MODEL	PACKAGE DESCRIPTION	SPECIFIED TEMPERATURE RANGE	ORDERING NUMBER	PACKAGE MARKING	PACKING OPTION
SGM2564A	WLCSP-1.45×0.95-6B	-40°C to +85°C	SGM2564AYG/TR	XXX RDE	Tape and Reel, 3000

**MARKING INFORMATION**

NOTE: XXX = Date Code and Trace Code.

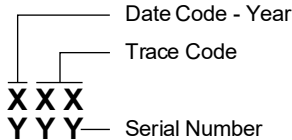

Green (RoHS & HSF): SG Micro Corp defines "Green" to mean Pb-Free (RoHS compatible) and free of halogen substances. If you have additional comments or questions, please contact your SGMICRO representative directly.

**ABSOLUTE MAXIMUM RATINGS**

Input Voltage Range, V <sub>IN</sub> .....	-0.3V to 6V
Output Voltage Range, V <sub>OUT</sub> .....	-0.3V to 6V
ON Pin Voltage Range, V <sub>ON</sub> .....	-0.3V to 6V
Maximum Continuous Switch Current, I <sub>MAX</sub> .....	4A
Package Thermal Resistance	
WLCSP-1.45×0.95-6B, θ <sub>JA</sub> .....	137.2°C/W
Junction Temperature .....	+150°C
Storage Temperature Range .....	-65°C to +150°C
Lead Temperature (Soldering, 10s) .....	+260°C
ESD Susceptibility	
HBM .....	4000V
CDM .....	1000V

**RECOMMENDED OPERATING CONDITIONS**

Input Voltage Range, V <sub>IN</sub> .....	1V to 5.5V
Output Voltage Range, V <sub>OUT</sub> .....	0V to 5.5V
ON Pin Input High Voltage, V <sub>IH</sub> .....	1.1V to 5.5V
ON Pin Input Low Voltage, V <sub>IL</sub> .....	0V to 0.4V
Operating Ambient Temperature Range .....	-40°C to +85°C
Operating Junction Temperature Range .....	-40°C to +125°C

**OVERSTRESS CAUTION**

Stresses beyond those listed in Absolute Maximum Ratings may cause permanent damage to the device. Exposure to absolute maximum rating conditions for extended periods may affect reliability. Functional operation of the device at any conditions beyond those indicated in the Recommended Operating Conditions section is not implied.

**ESD SENSITIVITY CAUTION**

This integrated circuit can be damaged if ESD protections are not considered carefully. SGMICRO recommends that all integrated circuits be handled with appropriate precautions. Failure to observe proper handling and installation procedures can cause damage. ESD damage can range from subtle performance degradation to complete device failure. Precision integrated circuits may be more susceptible to damage because even small parametric changes could cause the device not to meet the published specifications.

**DISCLAIMER**

SG Micro Corp reserves the right to make any change in circuit design, or specifications without prior notice.

PIN CONFIGURATION

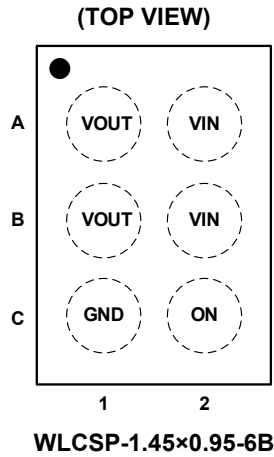

PIN DESCRIPTION

PIN	NAME	FUNCTION
A1, B1	VOUT	Switch Output.
A2, B2	VIN	Switch Input. Use a bypass capacitor (ceramic) to ground.
C1	GND	Ground.
C2	ON	Switch Control Input. High level is active. Do not float this pin.

FUNCTIONAL BLOCK DIAGRAM

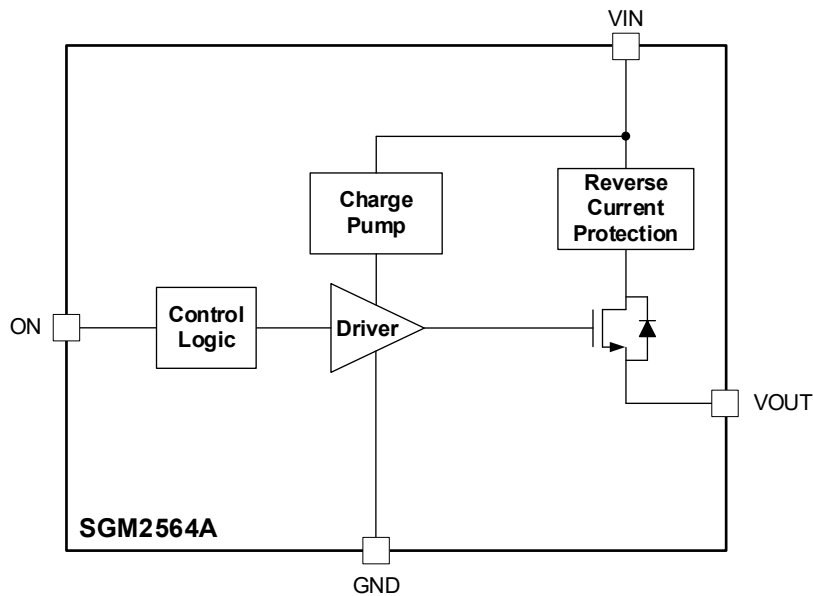

**ELECTRICAL CHARACTERISTICS**(T<sub>J</sub> = -40°C to +85°C, V<sub>IN</sub> = 1V to 5.5V, C<sub>IN</sub> = 1μF, C<sub>OUT</sub> = 0.1μF, typical values are at T<sub>J</sub> = +25°C, unless otherwise noted.)

PARAMETER	SYMBOL	CONDITIONS	MIN	TYP	MAX	UNITS
Input Voltage Range	V <sub>IN</sub>		1		5.5	V
Quiescent Current	I <sub>Q</sub>	V <sub>IN</sub> = 5.5V, V <sub>ON</sub> = 1.2V, I <sub>OUT</sub> = 0mA		580	960	nA
		V <sub>IN</sub> = 3.3V, V <sub>ON</sub> = 1.2V, I <sub>OUT</sub> = 0mA		420	700	
		V <sub>IN</sub> = 1V, V <sub>ON</sub> = 1.2V, I <sub>OUT</sub> = 0mA		280	520	
Shutdown Current	I <sub>SD</sub>	V <sub>IN</sub> = 5.5V, V <sub>ON</sub> = 0V		170	550	nA
Supply Leakage Current in Shutdown Mode	I <sub>LEAKAGE</sub>	V <sub>IN</sub> = 5.5V, V <sub>ON</sub> = 0V, V <sub>OUT</sub> = 0V			1500	nA
On-Resistance	R <sub>ON</sub>	V <sub>IN</sub> = 3.3V, V <sub>ON</sub> = 1.2V, I <sub>OUT</sub> = -200mA		16	35	mΩ
		V <sub>IN</sub> = 1.8V, V <sub>ON</sub> = 1.2V, I <sub>OUT</sub> = -200mA		16	35	mΩ
ON Pin Hysteresis	V <sub>HYS</sub>	V <sub>IN</sub> = 5V		57		mV
		V <sub>IN</sub> = 3.3V		47		
		V <sub>IN</sub> = 1.8V		37		
		V <sub>IN</sub> = 1V		32		
ON Pin Leakage Current	I <sub>ON</sub>	V <sub>ON</sub> = 5.5V			720	nA
Reverse Current When Disabled	I <sub>RC</sub>	V <sub>IN</sub> = V <sub>ON</sub> = 0V, V <sub>OUT</sub> = 5V			1	μA
ON Pin Input Low Voltage	V <sub>IL</sub>				0.4	V
ON Pin Input High Voltage	V <sub>IH</sub>		1.1			

**SWITCHING CHARACTERISTICS**

(C<sub>IN</sub> = 1μF, R<sub>OUT</sub> = 10Ω, C<sub>OUT</sub> = 0.1μF, typical values are at T<sub>J</sub> = +25°C, unless otherwise noted.)

PARAMETER	SYMBOL	CONDITIONS	MIN	TYP	MAX	UNITS
<b>V<sub>IN</sub> = 5.0V, T<sub>J</sub> = +25°C, unless otherwise noted.</b>						
Turn-On Time	t <sub>ON</sub>	Figure 2 and Figure 3		1240		μs
Turn-Off Time	t <sub>OFF</sub>			10		
V <sub>OUT</sub> Rise Time	t <sub>R</sub>			1020		
V <sub>OUT</sub> Fall Time	t <sub>F</sub>			5		
Delay Time	t <sub>D</sub>			940		
<b>V<sub>IN</sub> = 3.3V, T<sub>J</sub> = +25°C, unless otherwise noted.</b>						
Turn-On Time	t <sub>ON</sub>	Figure 2 and Figure 3		1100		μs
Turn-Off Time	t <sub>OFF</sub>			10		
V <sub>OUT</sub> Rise Time	t <sub>R</sub>			850		
V <sub>OUT</sub> Fall Time	t <sub>F</sub>			5		
Delay Time	t <sub>D</sub>			870		

**PARAMETER MEASUREMENT INFORMATION**

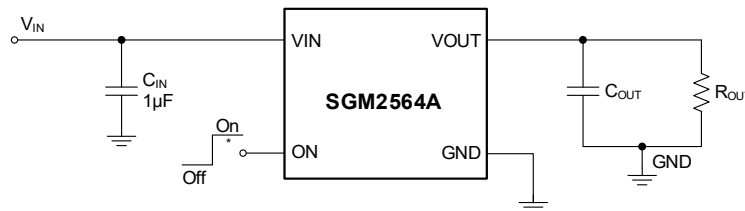

\*: Rise and fall times of the control signal are 100ns.

Figure 2. Test Circuit

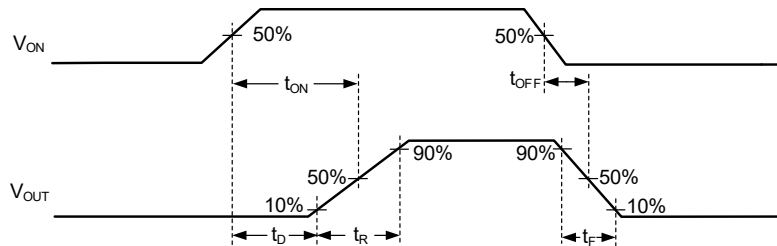
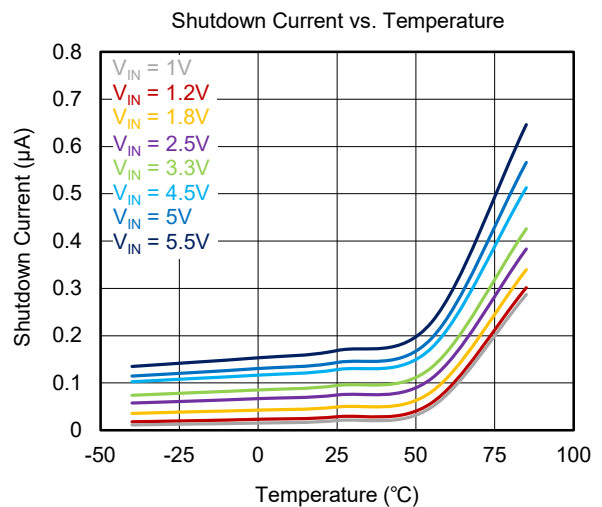
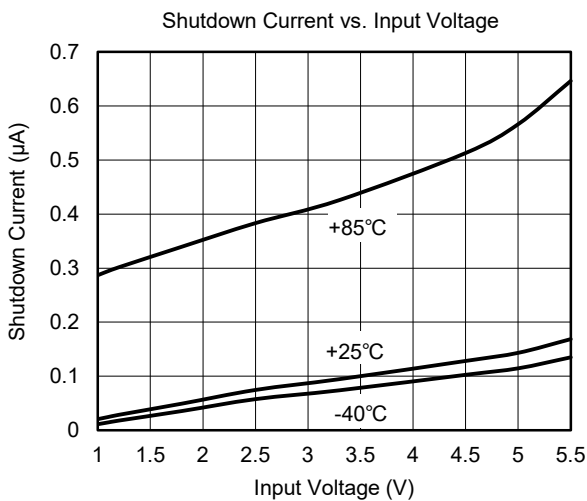
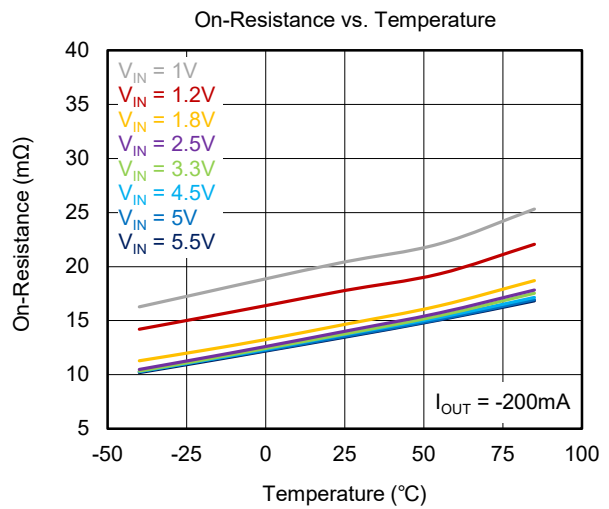
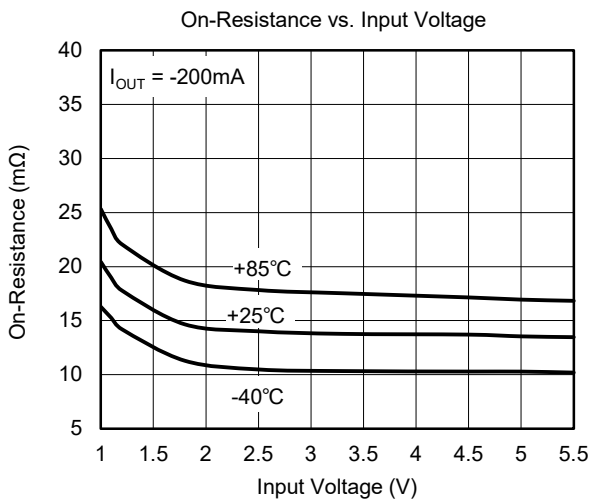
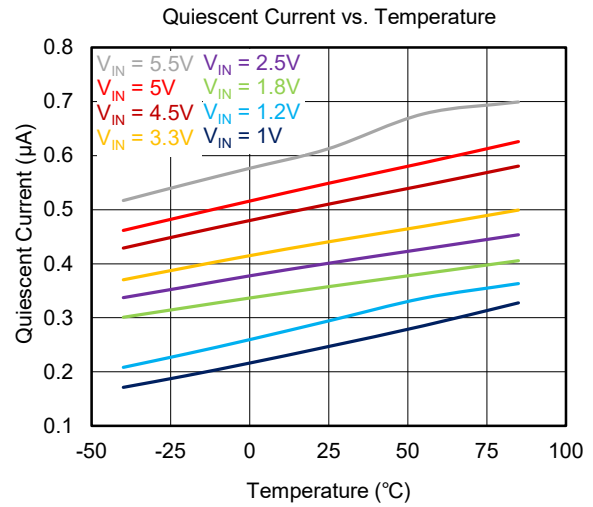
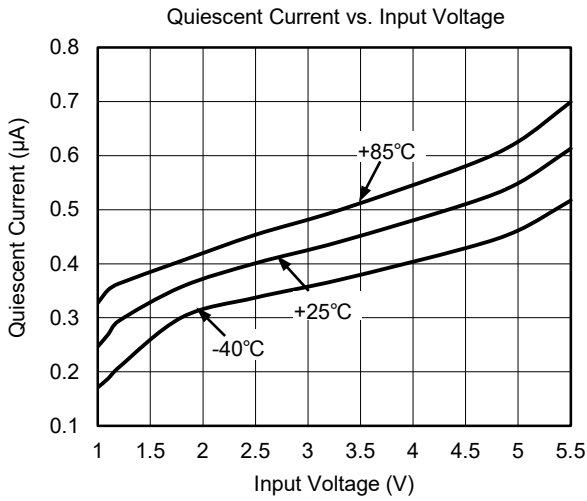

Figure 3. Timing Waveforms

TYPICAL PERFORMANCE CHARACTERISTICS

T<sub>J</sub> = +25°C, C<sub>IN</sub> = 1μF, C<sub>OUT</sub> = 0.1μF, R<sub>OUT</sub> = 10Ω, V<sub>IH</sub> = 1.2V, V<sub>IL</sub> = 0V, unless otherwise noted.



TYPICAL PERFORMANCE CHARACTERISTICS (continued)

T<sub>J</sub> = +25°C, C<sub>IN</sub> = 1μF, C<sub>OUT</sub> = 0.1μF, R<sub>OUT</sub> = 10Ω, V<sub>IH</sub> = 1.2V, V<sub>IL</sub> = 0V, unless otherwise noted.

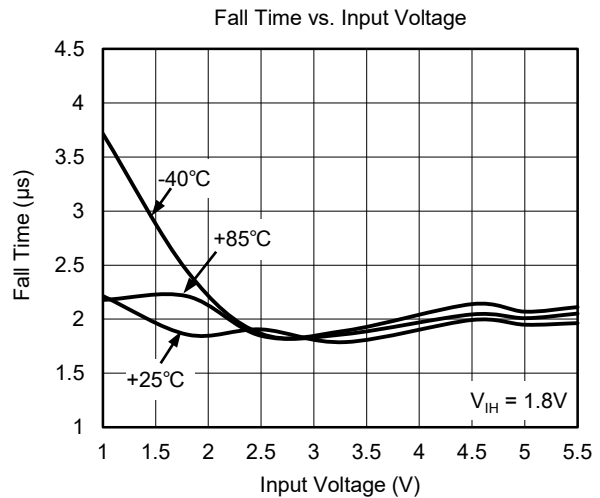
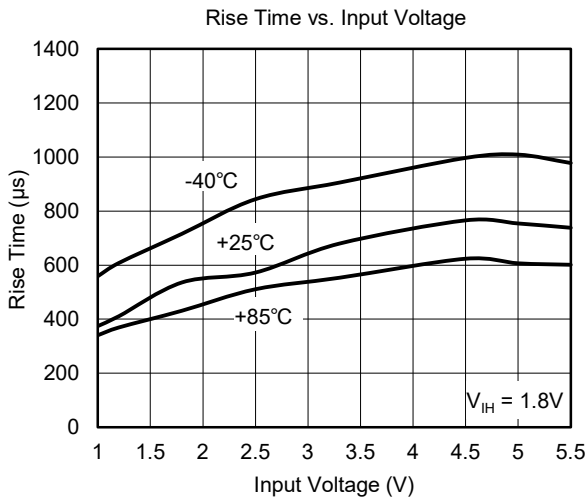
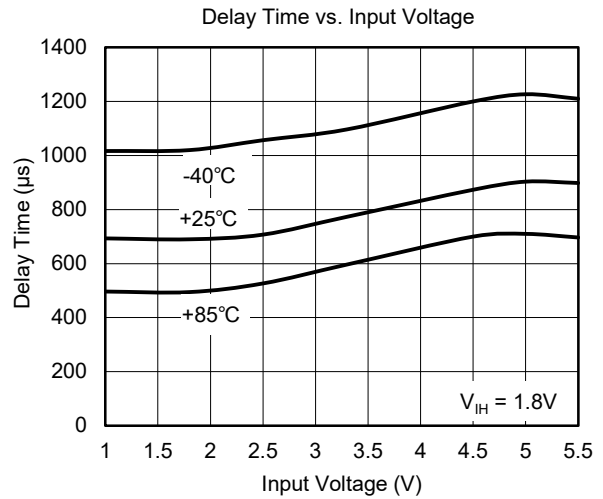
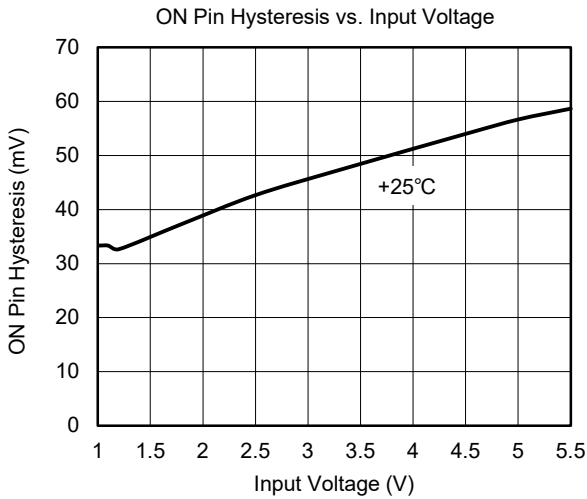
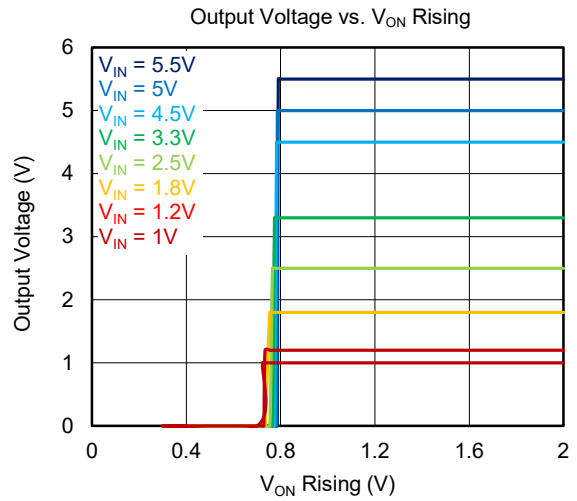
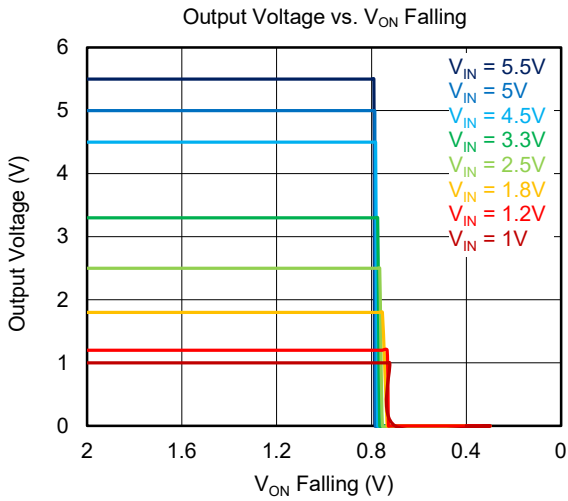

TYPICAL PERFORMANCE CHARACTERISTICS (continued)

T<sub>J</sub> = +25°C, C<sub>IN</sub> = 1μF, C<sub>OUT</sub> = 0.1μF, R<sub>OUT</sub> = 10Ω, V<sub>IH</sub> = 1.2V, V<sub>IL</sub> = 0V, unless otherwise noted.

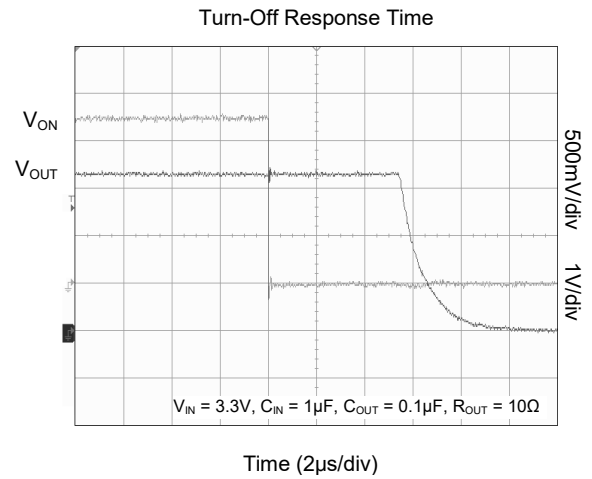
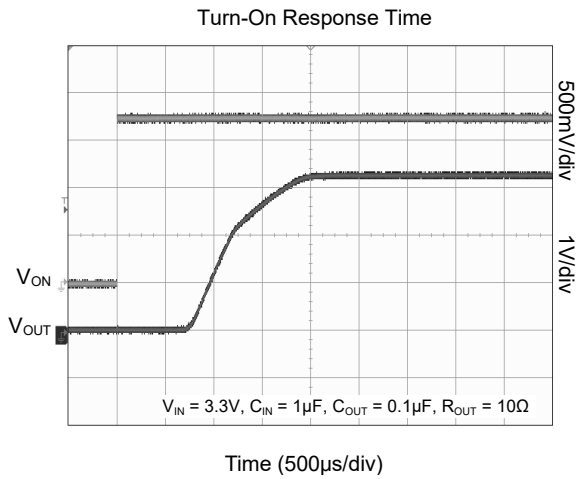
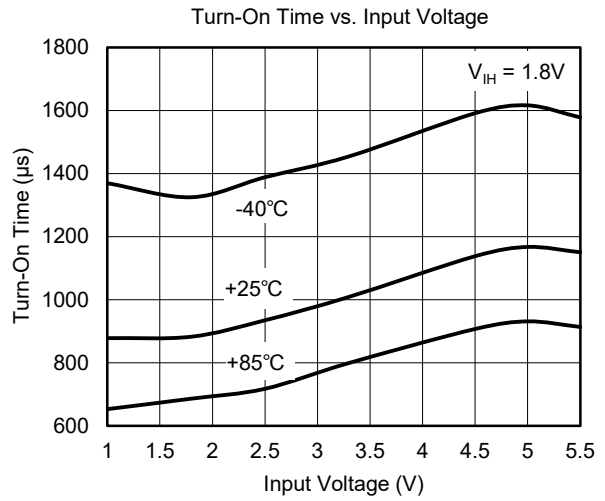
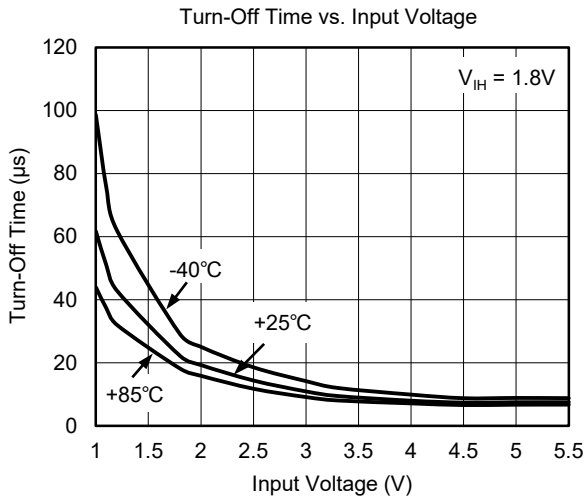



**DETAILED DESCRIPTION**

The SGM2564A is a small, 4A load switch. A low on-resistance N-MOSFET is integrated, which makes a low voltage drop across the device. To choose suitable rise time is always used to avoid inrush current.

**Control Pin**

The ON pin can control the device. Pulling the ON pin high enables the device. Logic high of V<sub>IH</sub> on the ON pin will enable the device and V<sub>IL</sub> will turn off it. It has the ability to interface with low-voltage GPIO. It can support with 1.2V GPIOs.

**APPLICATION INFORMATION**

SGM2564A is a single channel, up to 4A current capability load switch with low on-resistance. The device has a wide input range, which can be used in different end equipment to set power sequence, reduce inrush current and maintain low standby leakage current. The typical application circuit of SGM2564A is shown in Figure 4.

From the Equation 1, we can also calculate the soft-start time.

$$dt = C_{OUT} \times V_{OUT} / I_{INRUSH} \tag{2}$$

In this example: C<sub>OUT</sub> = 4.7μF, V<sub>OUT</sub> = V<sub>IN</sub> = 3.3V, I<sub>INRUSH</sub> = 30mA.

So,

$$dt = 4.7\mu F \times 3.3V / 30mA \approx 517\mu s \tag{3}$$

To ensure an inrush current is less than 30mA, the soft-start time cannot be less than 517μs. The SGM2564A has a typical rise time of 1020μs at 5V which meets the above design requirements.

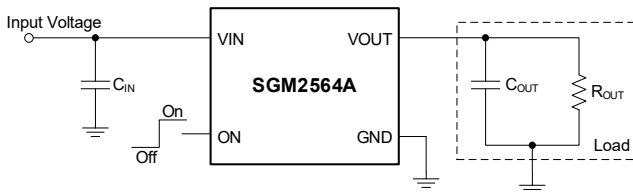

Figure 4. Typical Application Circuit

**Design Requirements**

Design Parameter	Value
Input Voltage (V <sub>IN</sub> )	3.3V
Load Capacitance (C <sub>OUT</sub> )	4.7μF
Maximum Acceptable Inrush Current (I <sub>INRUSH</sub> )	30mA

**Input Capacitor**

A 1μF input capacitor (C<sub>IN</sub>) is recommended to use between VIN and GND close to the device pins. It can limit the voltage drop on the input supply. Larger C<sub>IN</sub> can reduce voltage dip in high current applications.

**Output Capacitor**

A 0.1μF output capacitor (C<sub>OUT</sub>) should be placed between V<sub>OUT</sub> and GND close to the device pins. This capacitor will prevent parasitic board inductances from forcing V<sub>OUT</sub> below GND when the switch is turned off. To improve the VIN dropping when the device is turned on, it is recommended that C<sub>IN</sub> is placed greater than C<sub>OUT</sub>, due to the C<sub>IN</sub> is charge for C<sub>OUT</sub>.

**Inrush Current**

When the switch is enabled, V<sub>OUT</sub> begins to soft-start from 0V linearly. Inrush current can be calculated by the following formula.

$$I_{INRUSH} = C_{OUT} \times \frac{dV_{OUT}}{dt} \tag{1}$$

APPLICATION INFORMATION (continued)

Saving Standby Power

In battery-powered equipment, the strict power budget must be met under different operating modes. In standby or sleep mode, leakage current of some modules such as LCD displays, Wi-Fi, power amplifiers and GPS may be up to several mA or more. The large consumption is far from meeting the application requirements. Using load switches ahead of these modules can reduce this leakage current to μA/nA level, which can save the standby power consumption greatly. The configuration is illustrated in Figure 5.

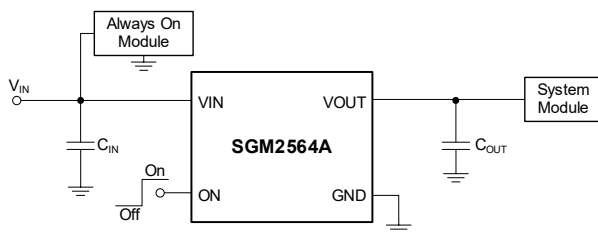
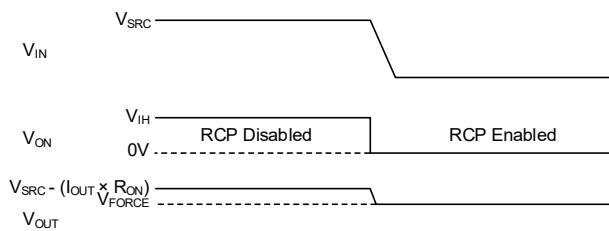

Figure 5. Standby Power Reduction

Reverse Current Protection

If the ON pin is pulled low, the device is disabled, while  $V_{IN} > 1V$  or  $V_{OUT} > 1V$  is met, the reverse current protection function is activated. This function prevents the current flowing from VOUT to VIN, and is very useful when SGM2564A is disabled and the output needs to be driven by another voltage source.



NOTES:  $V_{SRC}$  is the input power supply to the equipment.  $V_{FORCE}$  is the external power source forced at VOUT pin.

Figure 6. Reverse Current Protection

Figure 6 shows how the reverse current protection circuit is activated in SGM2564A. Pulling the ON pin down, the device is shut down and an external voltage ( $V_{FORCE}$ ) is forced to VOUT pin, the reverse current is tested very small given by  $I_{RC\_VIN}$ . This will prevent any large extra current reverse from the  $V_{FORCE}$  (added on  $V_{OUT}$ ) to  $V_{IN}$ .

Power Supply Recommendations

The SGM2564A is designed for a wide operate input voltage range of 1V to 5.5V. Place a 1μF input bypass capacitor close to the device terminal is recommended.

Power Supply Sequencing without a GPIO Input

In many terminal devices, each module needs to be powered up in a pre-determined manner. SGM2564A can set a power sequence by the  $t_{DELAY}$  without extra GPIO, and may reduce inrush current. Figure 7 shows the sequence that the ON pin of first load switch is tied to the VIN, and the second load switch ON pin is tied to the VOUT of first load switch. The second load switch is powered up when the first load switch is turned on, this is the fixed sequence and the delay time set by default  $t_{DELAY}$ .

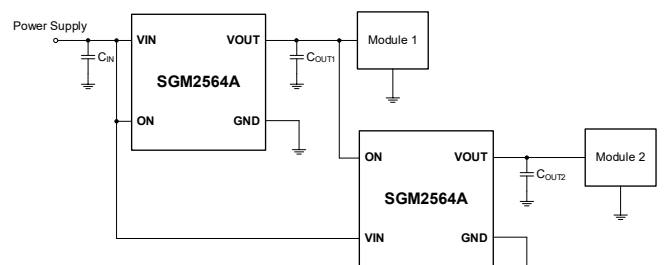

Figure 7. Power Supply Sequencing without a GPIO Input

REVISION HISTORY

NOTE: Page numbers for previous revisions may differ from page numbers in the current version.

Changes from Original (OCTOBER 2023) to REV.A	Page
Changed from product preview to production data.....	All

PACKAGE OUTLINE DIMENSIONS

WLCSP-1.45x0.95-6B

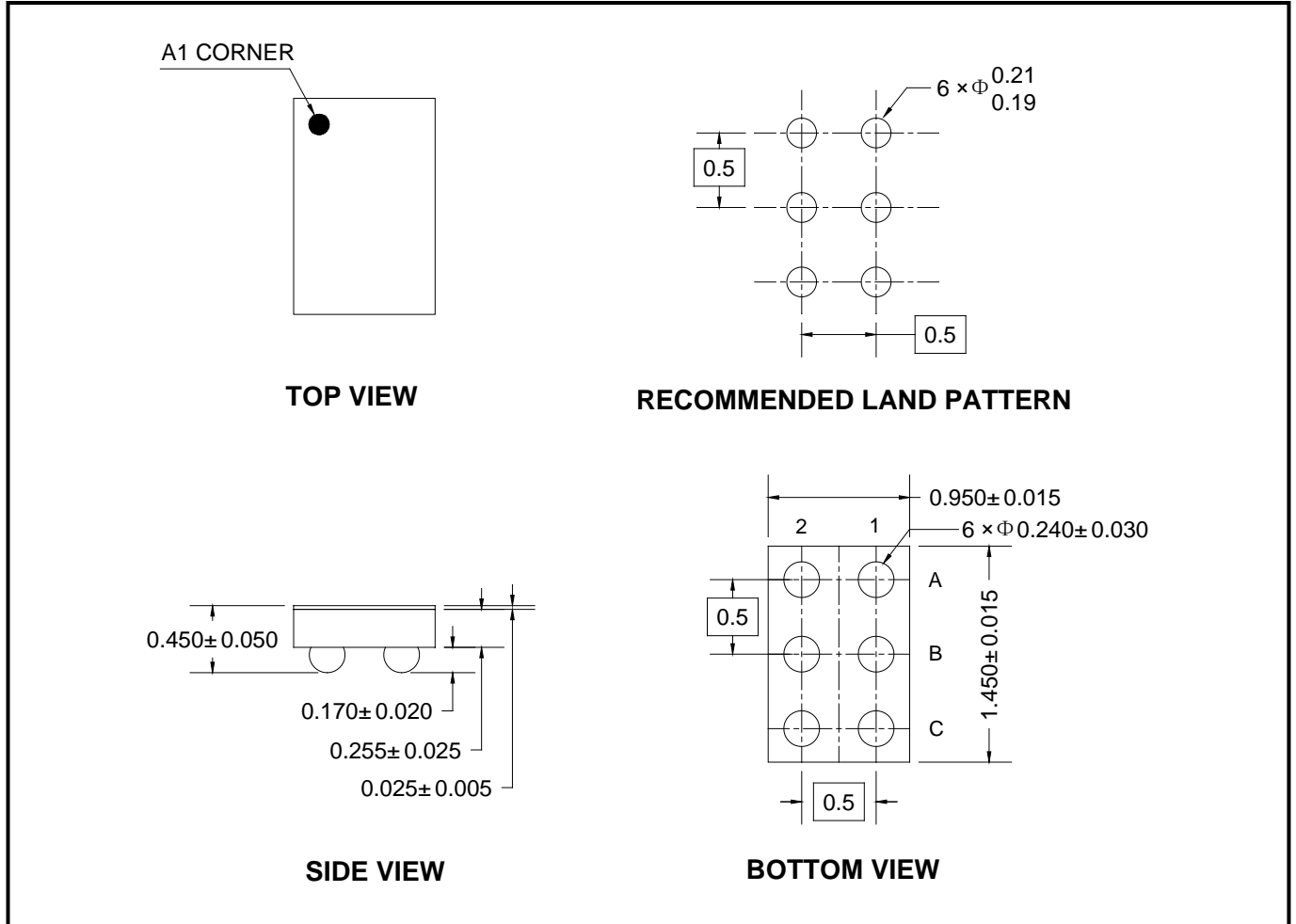

NOTES:

1. All linear dimensions are in millimeters.
2. This drawing is subject to change without notice.

# PACKAGE INFORMATION

## TAPE AND REEL INFORMATION

### REEL DIMENSIONS

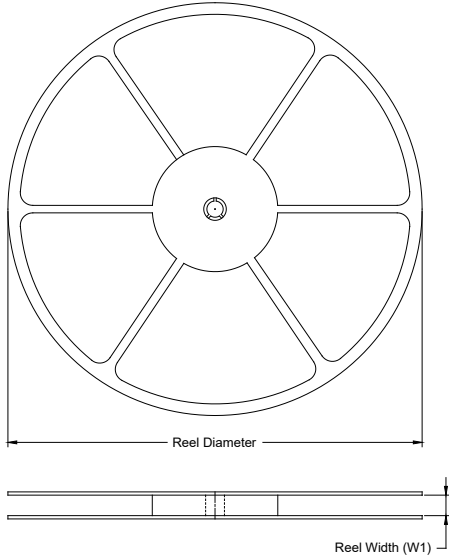

### TAPE DIMENSIONS

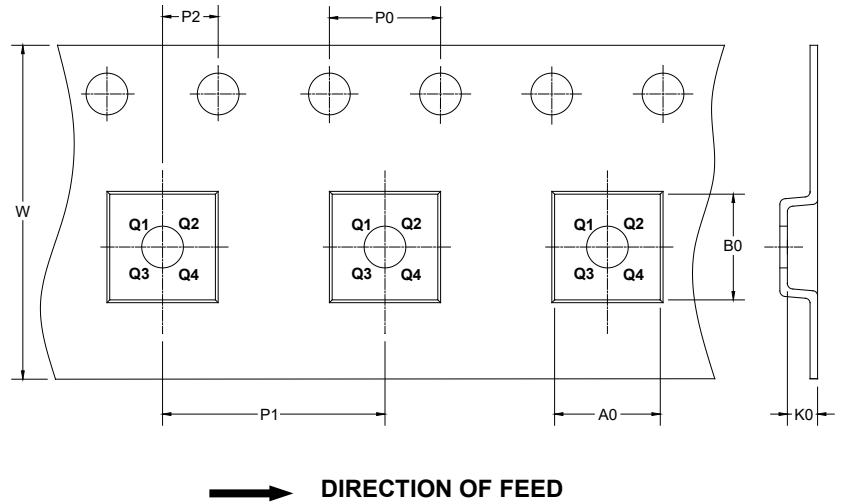

NOTE: The picture is only for reference. Please make the object as the standard.

### KEY PARAMETER LIST OF TAPE AND REEL

Package Type	Reel Diameter	Reel Width W1 (mm)	A0 (mm)	B0 (mm)	K0 (mm)	P0 (mm)	P1 (mm)	P2 (mm)	W (mm)	Pin1 Quadrant
WLCSP-1.45×0.95-6B	7"	9.0	1.12	1.57	0.62	4.0	4.0	2.0	8.0	Q1

DD0001

# PACKAGE INFORMATION

## CARTON BOX DIMENSIONS

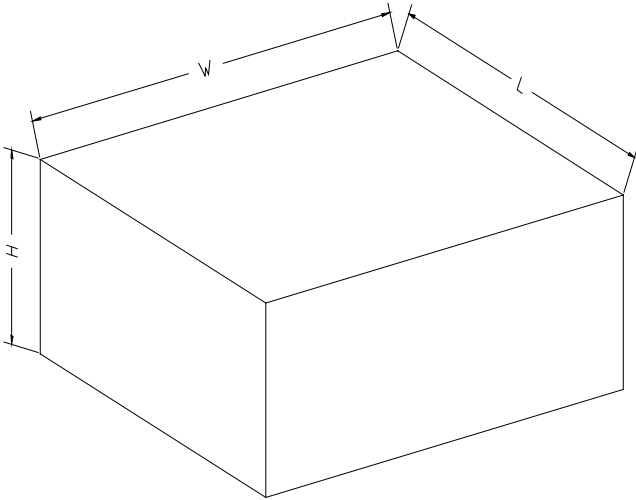

NOTE: The picture is only for reference. Please make the object as the standard.

## KEY PARAMETER LIST OF CARTON BOX

Reel Type	Length (mm)	Width (mm)	Height (mm)	Pizza/Carton
7" (Option)	368	227	224	8
7"	442	410	224	18

DD0002