



US2AF THRU US2MF

VOLTAGE RANGE 50 to 1000 Volts
CURRENT 2.0 Ampere



Features

- Fast recovery glass passivated chip
- Low forward voltage drop
- Low leakage current
- High forward surge capability
- High temperature soldering: 260°C/10S at terminals
- Component in accordance to ROHS 2002/95/1 and WEEE 2002/96/EC



Mechanical Data

- Case: JEDEC SMAF mold plastic Body over glass passivated chip
- Terminals: Solder plated, solderable per J-STD-002B and JESD22-B102D
- Polarity: Laser band denote cathode band
- Weight: 0.00095ounce, 0.028grams

Maximum Ratings and Electrical Characteristics

- Ratings at 25°C ambient temperature unless otherwise specified
- Single phase, half wave, 60Hz, resistive or inductive load
- For capacitive load derate current by 20%

TYPE NUMBER	SYMBOL	US 2AF	US 2BF	US 2DF	US 2GF	US 2JF	US 2KF	US 2MF	UNIT
Maximum Repetitive Peak Reverse Voltage	V_{RRM}	50	100	200	400	600	800	1000	Volts
Maximum RMS Voltage	V_{RMS}	35	70	140	280	420	560	700	Volts
Maximum DC Blocking Voltage	V_{DC}	50	100	200	400	600	800	1000	Volts
Maximum Average Forward Rectified Current At $T_A=100^\circ\text{C}$	$I_{(AV)}$	2.0							Amps
Peak Forward Surge Current 8.3ms single half sine wave superimposed on rated load (JEDEC Method)	I_{FSM}	60							Amps
Maximum Instantaneous Forward Voltage per at 2.0A	V_F	1.0			1.30	1.70		Volts	
Maximum DC Reverse Current at rated DC Blocking Voltage	$T_A = 25^\circ\text{C}$	5.0							μA
	$T_A = 125^\circ\text{C}$	100							
Typical Reverse Recovery Time Test conditions (Note 3)	T_{RR}	50				75		nS	
Typical Junction Capacitance (Note 2)	C_J	50				30		pF	
Typical Thermal Resistance (Note 1)	$R_{\theta JA}$	80							$^\circ\text{C/W}$
	$R_{\theta JL}$	35							
Operating Junction Temperature	T_J	-55 to +150							$^\circ\text{C}$
Storage Temperature Range	T_{STG}	-55 to +150							$^\circ\text{C}$

Notes:

1. Thermal resistance from Junction to ambient and from junction to lead mounted on PCB. with 0.2×0.2"(5.0 × 5.0mm) copper pad areas.
2. Measured at 1.0MHz and applied reverse voltage of 4.0V
3. Reverse Recovery Test Conditions: $I_f=0.5A, I_r=1.0A, I_{rr}=0.25A$.



US2AF THRU US2MF

VOLTAGE RANGE 50 to 1000 Volts
CURRENT 2.0 Ampere

Ratings and Characteristic Curves (T_A=25°C unless otherwise noted)

FIG.1-TYPICAL FORWARD CURRENT DERATING CURVE

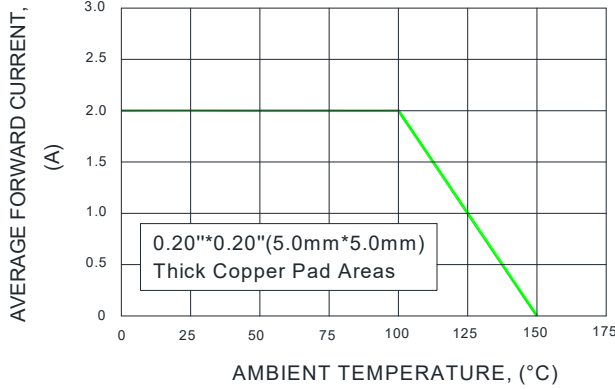

FIG.2-MAXIMUM NON-REPETITIVE PEAK FORWARD SURGE CURRENT

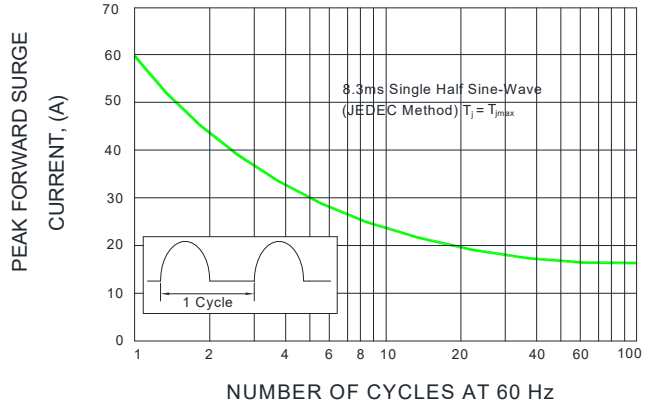

FIG.3-TYPICAL INSTANTANEOUS FORWARD CHARACTERISTICS

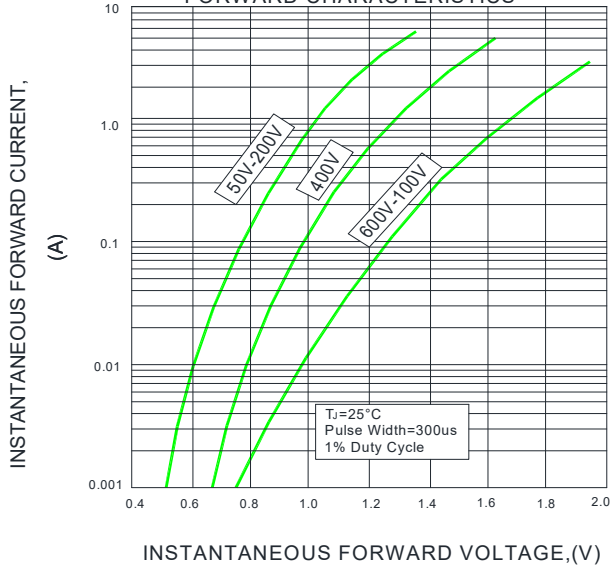

FIG.4-TYPICAL REVERSE CHARACTERISTICS

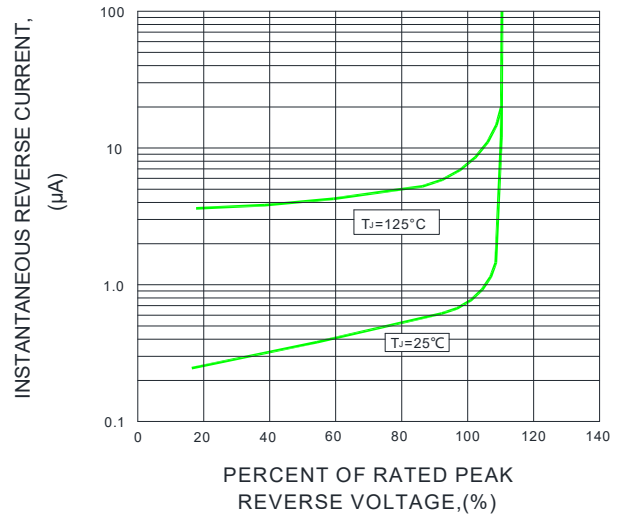

FIG.5-TYPICAL JUNCTION CAPACITANCE

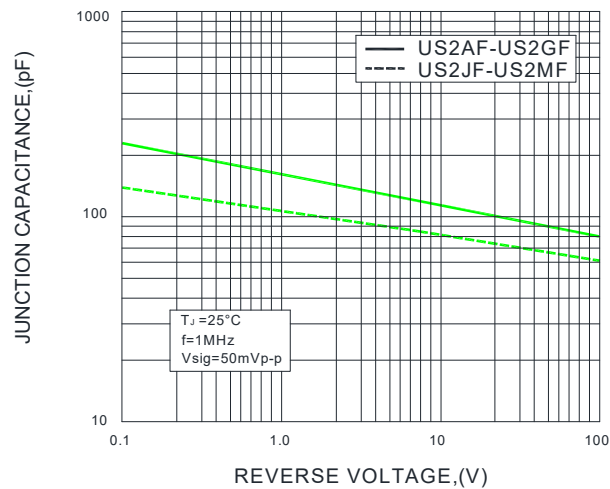
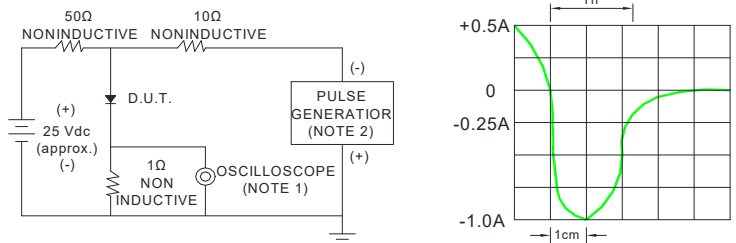

FIG.6-TEST CIRCUIT DIAGRAM AND REVERSE RECOVERY TIME CHARACTERISTIC



NOTES : 1. Rise Time=7ns max. Input Impedance= 1 magohm. 22pF
2. Rise time=10ns max. Source Impedance= 50 ohms

SET TIME BASE FOR 50/100ns/cm



US2AF THRU US2MF

VOLTAGE RANGE 50 to 1000 Volts
CURRENT 2.0 Ampere

Package Outline Dimensions in inches (millimeters)

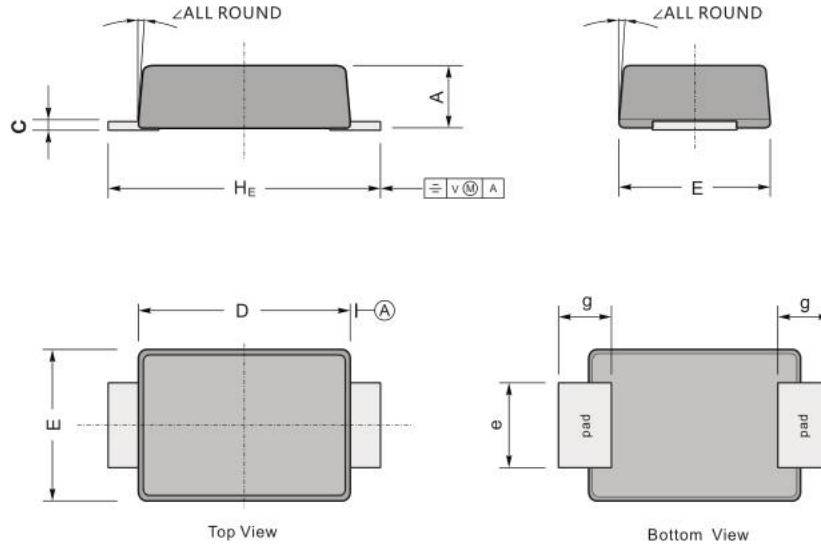

UNIT		A	C	D	E	e	g	HE	∠
mm	max	1.10	0.20	3.70	2.70	1.60	1.20	4.90	5-7°
	min	0.90	0.12	3.30	2.40	1.30	0.80	4.40	
mil	max	43	7.90	146	106	63	47	193	
	min	35	4.70	130	94	51	31	173	

The Recommended Mounting Pad Size

Marking

Type number	Marking code
US2AF	US2A
US2BF	US2B
US2DF	US2D
US2GF	US2G
US2JF	US2J
US2KF	US2K
US2MF	US2M

The recommended mounting pad size

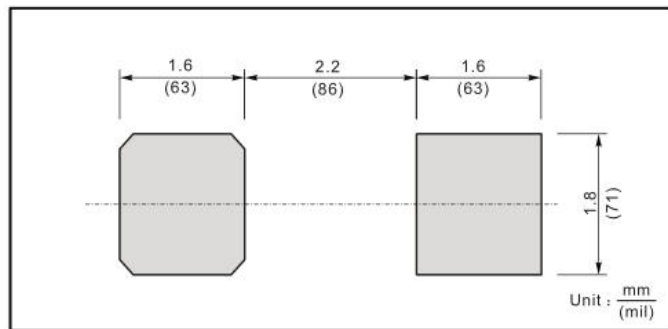



Packing Requirments

- PS black anti-static carrier tape packing

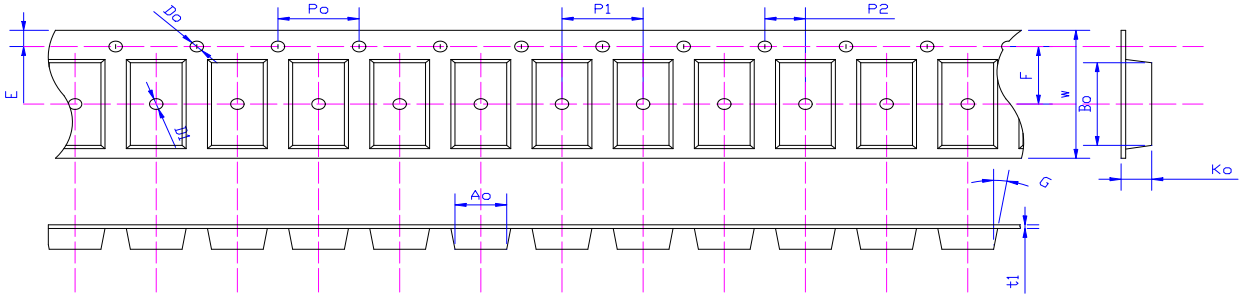

Specifications	Ao	Bo	Ko	Po	W	t1
SMAFL	2.83±0.10	4.90±0.10	1.45±0.10	4.00±0.1	12.0±0.05	0.23±0.02

- 13 "antistatic plastic reel

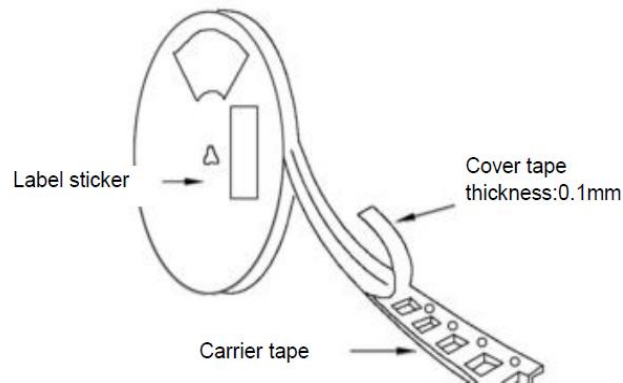

DEVICE TYPE	13" Reel			
	Q'TY/REEL(pcs)	REEL/BOX	BOX/CARTOON	Q'TY/CARTON(pcs)
SMAFL	10000	2	8	160000



Reflow Profile

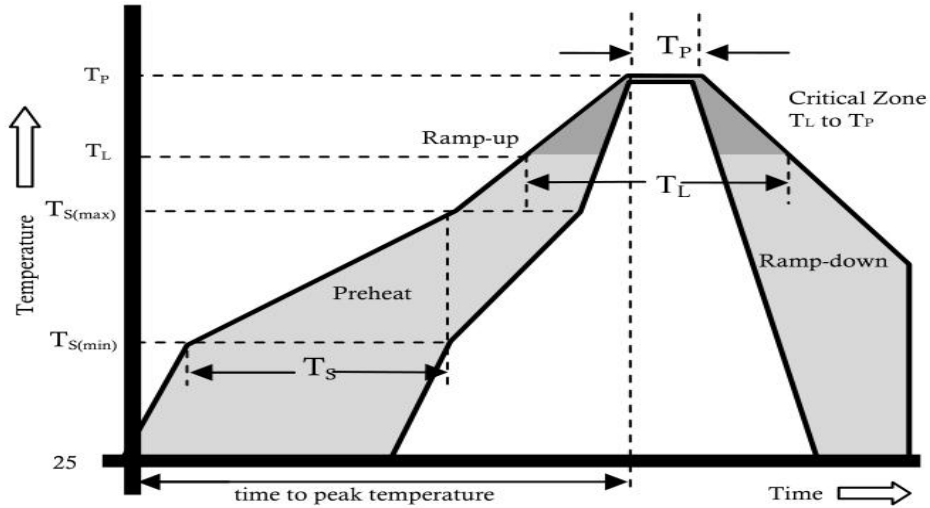

Reflow Condition		Pb-Free Assembly
Pre Heat	Temperature Min.	+150°C
	Temperature Max.	+200°C
	Time(Min to Max)	60-180 secs.
Average ramp up rate(Liquidus Temp(T_L) to peak)		3°C/sec. Max.
$T_{S(max)}$ to T_L - Ramp-up Rate		3°C/sec. Max.
Reflow	Temperature (T_L)(Liquidus)	+217°C
	Temperature (T_L)	60-150 secs.
Peak Temp (T_P)		+(260+0/-5) °C
Time within 5°C of actual Peak Temp (T_P)		25 secs.
Ramp-down Rate		6°C/sec. Max.
Time 25°C to peak Temp (T_P)		8 min. Max.
Do not exceed		+260°C



US2AF THRU US2MF

VOLTAGE RANGE 50 to 1000 Volts
CURRENT 2.0 Ampere

Disclaimer

The information presented in this document is for reference only. Chongqing changjie Electronic Technology Co., Ltd. reserves the right to make changes without notice for the specification of the products displayed herein to improve reliability, function or design or otherwise.

The product listed herein is designed to be used with ordinary electronic equipment or devices, and not designed to be used with equipment or devices which require high level of reliability and the malfunction of with would directly endanger human life (such as medical instruments, transportation equipment, aerospace machinery, nuclear-reactor controllers, fuel controllers and other safety devices), Changjie or anyone on its behalf, assumes no responsibility or liability for any damages resulting from such improper use of sale.

This publication supersedes & replaces all information previously supplied. For additional information, please visit our website [http:// www.czlangjie.com](http://www.czlangjie.com) , or consult your nearest Langjie's sales office for further assistance.