

Wafer Mapping Sensor M-DW1

Related Information

- General terms and conditions..... F-3
- Selection guide P.865~
- General precautions P.1552~

- FIBER SENSORS
- LASER SENSORS
- PHOTOELECTRIC SENSORS
- MICRO PHOTOELECTRIC SENSORS
- AREA SENSORS
- SAFETY LIGHT CURTAINS / SAFETY COMPONENTS
- PRESSURE / FLOW SENSORS
- INDUCTIVE PROXIMITY SENSORS
- PARTICULAR USE SENSORS**
- SENSOR OPTIONS
- SIMPLE WIRE-SAVING UNITS
- WIRE-SAVING SYSTEMS
- MEASUREMENT SENSORS
- STATIC CONTROL DEVICES
- LASER MARKERS
- PLC
- HUMAN MACHINE INTERFACES
- ENERGY MANAGEMENT SOLUTIONS
- FA COMPONENTS
- MACHINE VISION SYSTEMS
- UV CURING SYSTEMS



panasonic.net/id/pidsx/global

The safe LED beam reflective type wafer mapping sensor

Safe LEDs adopted

Conventional laser mapping sensor that adopts laser beam has been dangerous because an operator is exposed directly to laser beam, which comes out of the load port through FOUP. We have succeeded in developing LED to adopt as light source for **M-DW1**. Therefore an operator's safety is ensured.

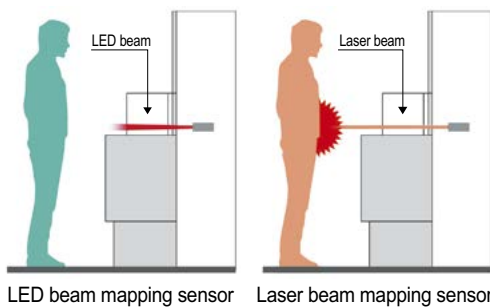

Sensing of nitride-coated wafers possible

Nitride-coated wafers absorb light at certain wavelengths depending on the coating thickness. If the sensor uses the laser beam having a single wavelength, the beam may be absorbed completely, resulting in wafer detection error. The **M-DW1** uses a LED light source with a wide wavelength band that allows to detect nitride-coated wafers successfully.

High-speed response time: 0.5 ms

The sensor responds in 0.5 ms, meeting the requirements of both high speed and high accuracy in wafer detection.

Glass wafers are also detectable

The **M-DW1**, which detects wafers not by the light amount but by the light position, can detect the glass wafers regardless of the light amount.

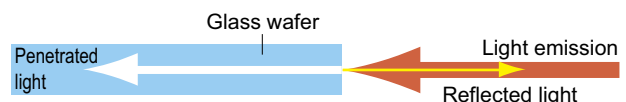

Precise position detection by 2-segment receiving element

Wafer detection by the amount of reflected light may sometimes fail depending on the wafer edge shape. The **M-DW1** uses 2-segment receiving element in the beam-receiving part, and detects wafers by the reflected light position instead of the amount of reflected light. Thus, the sensor is less affected by wafer thickness or the amount of reflected light.

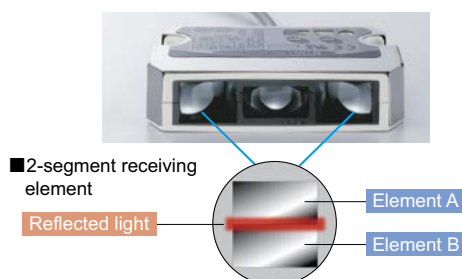

Compact and lightweight design with built-in amplifier

The sensor measures W80.6 mm × H18.3 mm × D50 mm
W3.173 in × H0.720 in × D1.969 in, and weights only 75 g approx.

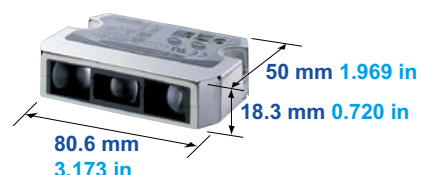

M-DW1

HD-T1

ORDER GUIDE

Appearance	Center sensing distance	Sensing object	Model No.	Output
	45 mm 1.772 in	3 inch or larger semiconductor wafer	M-DW1	NPN output / PNP output selectable by switch

SPECIFICATIONS

Item	Type	LED beam reflective type
Item	Model No.	M-DW1
CE marking directive compliance		EMC Directive, RoHS Directive
Center sensing distance		45 mm 1.772 in
Sensing object		3 inch or larger semiconductor wafer (Note 2)
Detectable surface		Surface having a side edge which reflects light in the light receiving direction (Note 3)
Sensing angle		12.5 ± 5° (Note 4)
Wafer pitch		Separate sensing is possible at normal sensitivity for 3 mm 0.118 in pitch or more (Note 5)
Suitable cassette		SEMI standard FOUP cassette / open cassette
Supply voltage		12 to 24 V DC ±10 % Ripple P-P 10 % or less
Current consumption		65 mA or less
Output		NPN output / PNP output, selectable with output selection switch <NPN output> NPN open-collector transistor • Maximum sink current: 100 mA • Applied voltage: 30 V DC or less (between output and 0 V) • Residual voltage: 1 V or less (at 100 mA sink current) 0.4 V or less (at 16 mA sink current) <PNP output> PNP open-collector transistor • Maximum source current: 100 mA • Applied voltage: 30 V DC or less (between output and +V) • Residual voltage: 1 V or less (at 100 mA source current) 0.4 V or less (at 16 mA source current)
	Utilization category	DC-12 or DC-13
	Output operation	Light-ON/Dark-ON, selectable by switch
	Short-circuit protection	Incorporated (restored automatically)
Response time		500 μs or less
Operation indicator		Orange LED (lights up when the output is ON)
Stability indicator		Green LED (lights up under stable light received condition or stable dark condition)
Timer function		Approx. 2 ms fixed OFF-delay timer, switchable either effective or ineffective
Test input (emission halt input)		Signal condition • Emission Halt: Open, or 4 to 8 V • Emission: 0 to 3 V, or 9 V to +V (26.4 V max.)
Sensitivity selection input		Signal condition • Input OFF: Open, or 4 to 8 V • Input ON: 0 to 3 V, or 9 V to +V (26.4 V max.)
Sensitivity setting		Back surface teaching: effectuated with sensor's sensitivity setting button Detection sensitivity selection: 4 levels with sensor's 2 bit switch or 2 levels with external input selectable
Environmental resistance	Pollution degree	3 (Industrial environment)
	Protection	IP20 (IEC)
	Ambient temperature	0 to +55 °C +32 to +131 °F (No dew condensation), Storage: -10 to +70 °C +14 to +158 °F
	Ambient humidity	35 to 85 % RH, Storage: 35 to 85 % RH
	Ambient illuminance	Incandescent light: 3,000 lx or less at the light-receiving face, Fluorescent light: 1,500 lx or less at the light-receiving face
	Voltage withstandability	1,000 V AC for one min. between all supply terminals connected together and enclosure
	Insulation resistance	20 MΩ, or more, with 250 V DC megger between all supply terminals connected together and enclosure
	Vibration resistance	10 to 500 Hz frequency, 3 mm 0.118 in double amplitude in X, Y and Z directions for two hours each
Shock resistance	98 m/s ² acceleration (10 G approx) in X, Y and Z directions five times each	
Emitting element		LED (modulated)
Material		Enclosure: ABS and Stainless steel (SUS301), Lens: Acrylic
Cable		0.15 mm ² 5-core cabtyre cable, 300 mm 11.811 in long
Cable extension		Extension up to total 10 m 32.808 ft is possible with 0.15 mm ² , or more, cable.
Weight		Net weight: 75 g approx.

- Notes: 1) Where measurement conditions have not been specified precisely, the conditions used were an ambient temperature of +20 °C **+68 °F**.
 2) In case of 8 inch or less wafers, the wafer pitch, the orientation flat or surface condition may affect the sensing.
 3) Polished wafers, etc., which have a sharp edge cannot be detected since they do not reflect the light in the light receiving direction.
 4) Since the position of the orientation flat may vary by ±20° due to its rotation, refer to "**Detecting wafer having orientation flat**" (p.918) for detection of a wafer having an orientation flat.
 5) This is the pitch of an 8 inch wafer near its center region when it is inserted in an inclined fashion. When detecting a wafer having an orientation flat, the wafer pitch becomes still smaller when sensing at positions which avoid the orientation flat. In this case, the sensing signal cannot be resolved and it becomes a continuous, broad signal. For details, refer to "**Sensing signal**" (p.919~).

FIBER SENSORS
 LASER SENSORS
 PHOTO-ELECTRIC SENSORS
 MICRO PHOTO-ELECTRIC SENSORS
 AREA SENSORS
 SAFETY LIGHT CURTAINS / SAFETY COMPONENTS
 PRESSURE / FLOW SENSORS
 INDUCTIVE PROXIMITY SENSORS
 PARTICULAR USE SENSORS
 SENSOR OPTIONS
 SIMPLE WIRE-SAVING UNITS
 WIRE-SAVING SYSTEMS
 MEASUREMENT SENSORS
 STATIC CONTROL DEVICES
 LASER MARKERS
 PLC
 HUMAN MACHINE INTERFACES
 ENERGY MANAGEMENT SOLUTIONS
 FA COMPONENTS
 MACHINE VISION SYSTEMS
 UV CURING SYSTEMS
 Selection Guide
 Liquid Leak Detection
 Liquid Level Detection
 Water Detection
 Color Mark Detection
 Wafer Detection
 Ultrasonic
 Small / Slim Object Detection
 Obstacle Detection

M-DW1
HD-T1

- FIBER SENSORS
- LASER SENSORS
- PHOTO-ELECTRIC SENSORS
- MICRO PHOTO-ELECTRIC SENSORS
- AREA SENSORS
- SAFETY LIGHT CURTAINS / SAFETY COMPONENTS
- PRESSURE / FLOW SENSORS
- INDUCTIVE PROXIMITY SENSORS
- PARTICULAR USE SENSORS
- SENSOR OPTIONS
- SIMPLE WIRE-SAVING UNITS
- WIRE-SAVING SYSTEMS
- MEASUREMENT SENSORS
- STATIC CONTROL DEVICES
- LASER MARKERS
- PLC
- HUMAN MACHINE INTERFACES
- ENERGY MANAGEMENT SOLUTIONS
- FA COMPONENTS
- MACHINE VISION SYSTEMS
- UV CURING SYSTEMS
- Selection Guide
- Liquid Leak Detection
- Liquid Level Detection
- Water Detection
- Color Mark Detection
- Wafer Detection
- Ultrasonic
- Small / Slim Object Detection
- Obstacle Detection

I/O CIRCUIT DIAGRAMS

NPN output

I/O circuit diagram

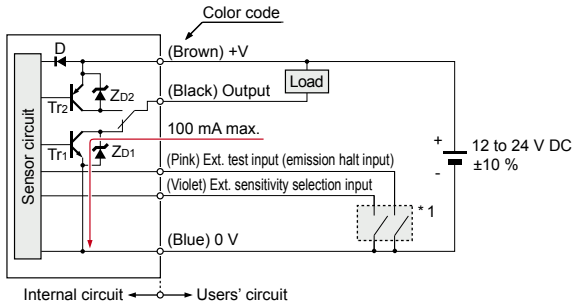

Symbols ... D: Reverse supply polarity protection diode
 ZD1, ZD2: Surge absorption zener diode
 Tr1: NPN output transistor
 Tr2: PNP output transistor

Wiring diagram

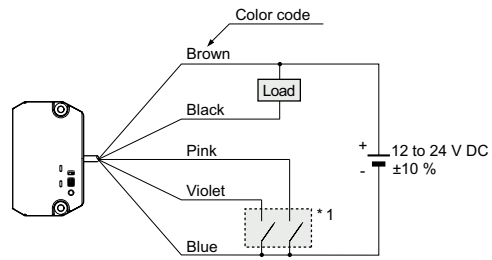

* 1

Non-voltage contact or NPN open-collector transistor

- External test input (emission halt input)
 0 to 3 V, or 9 V to +V (26.4 V max.): Emission halt
 Open, or 4 to 8 V: Emission
- External sensitivity selection input
 0 to 3 V, or 9 V to +V (26.4 V max.): Input ON
 Open, or 4 to 8 V: Input OFF

PNP output

I/O circuit diagram

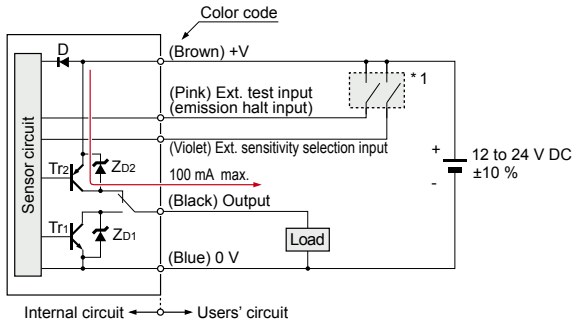

Symbols ... D: Reverse supply polarity protection diode
 ZD1, ZD2: Surge absorption zener diode
 Tr1: NPN output transistor
 Tr2: PNP output transistor

Wiring diagram

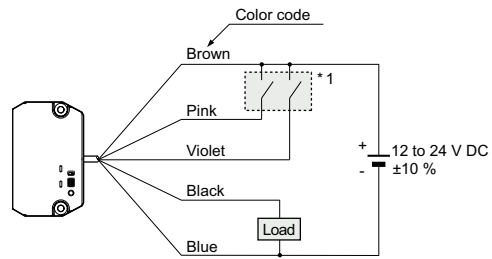

* 1

Non-voltage contact or PNP open-collector transistor

- External test input (emission halt input)
 0 to 3 V, or 9 V to +V (26.4 V max.): Emission halt
 Open, or 4 to 8 V: Emission
- External sensitivity selection input
 0 to 3 V, or 9 V to +V (26.4 V max.): Input ON
 Open, or 4 to 8 V: Input OFF

PRECAUTIONS FOR PROPER USE

Refer to p.1552~ for general precautions.

FIBER SENSORS

LASER SENSORS

PHOTO-ELECTRIC SENSORS

MICRO PHOTO-ELECTRIC SENSORS

AREA SENSORS

SAFETY LIGHT CURTAINS / SAFETY COMPONENTS

PRESSURE / FLOW SENSORS

INDUCTIVE PROXIMITY SENSORS

PARTICULAR USE SENSORS

SENSOR OPTIONS

SIMPLE WIRE-SAVING UNITS

WIRE-SAVING SYSTEMS

MEASUREMENT SENSORS

STATIC CONTROL DEVICES

LASER MARKERS

PLC

HUMAN MACHINE INTERFACES

ENERGY MANAGEMENT SOLUTIONS

FA COMPONENTS

MACHINE VISION SYSTEMS

UV CURING SYSTEMS

Selection Guide

Liquid Leak Detection

Liquid Level Detection

Water Detection

Color Mark Detection

Wafer Detection

Ultrasonic

Small / Slim Object Detection

Obstacle Detection

M-DW1

HD-T1



- Never use this product as a sensing device for personnel protection.
- In case of using sensing devices for personnel protection, use products which meet laws and standards, such as OSHA, ANSI or IEC etc., for personnel protection applicable in each region or country.

Mounting

- Set the distance between the sensor detection surface and the wafer edge to be 45 mm **1.772 in** and mount the sensor so that sensing is done at an angle of 12.5° with respect to the wafer. Mount using M4 (length 16 mm **0.630 in**) screws. The tightening torque should be 1.2 N·m or less. Further, although the sensing distance may change due to variation in the wafer position (wafer protrusion, orientation flat position, etc.), if it is within 5 mm **0.197 in**, stable sensing is possible.

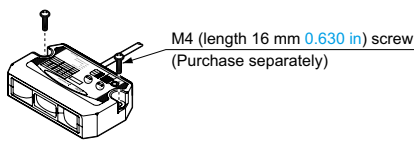

Top-view

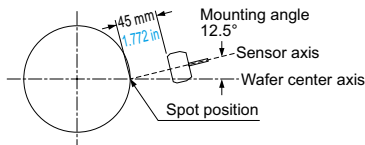

Note: If the wafer center axis and the sensor axis lie along a straight line (0°), detection is not possible. Always mount the sensor at an angle to the wafer.

Wiring

- Make sure that the power supply is off while wiring.
- Take care that wrong wiring will damage the product.
- Verify that the supply voltage variation is within the rating.
- If power is supplied from a commercial switching regulator, ensure that the frame ground (F.G.) terminal of the power supply is connected to an actual ground.
- In case noise generating equipment (switching regulator, inverter motor, etc.) is used in the vicinity of this product, connect the frame ground (F.G.) terminal of the equipment to an actual ground.
- Extension up to total 10 m **32.808 ft**, or less, is possible with 0.15 mm², or more, cable. However, in order to reduce noise, make the wiring as short as possible.
- Do not run the wires together with high-voltage lines or power lines or put them in the same raceway. This can cause malfunction due to induction.
- Make sure to use an isolation transformer for the DC power supply. If an autotransformer (single winding transformer) is used, this product or the power supply may get damaged.
- In case a surge is generated in the used power supply, connect a surge absorber to the supply and absorb the surge.

Others

- Do not use during the initial transient time (0.5 sec.) after the power supply is switched on.
- Take care that the sensor is not directly exposed to fluorescent lamp from a rapid-starter lamp, a high frequency lighting device or sunlight etc., as it may affect the sensing performance.
- Avoid dust, dirt, and steam.
- Take care that the product does not come in contact with water, oil, grease or organic solvents, such as, thinner, etc.
- Do not allow any water, oil, fingerprints, etc., which may refract light, or dust, dirt, etc., which may block light, to stick to the sensing surfaces of the sensor. In case they are present, wipe them with a clean, dust-free soft cloth or lens paper.

Detecting wafer having orientation flat

- When detecting a wafer having an orientation flat, mount the sensor so that a portion other than the orientation flat is detected. Further, arrange to detect the wafer from two different angles by moving the robot arm, etc., and OR the signal so obtained.

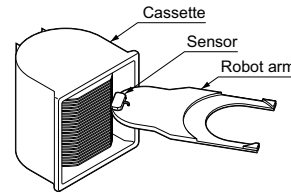

Top-view

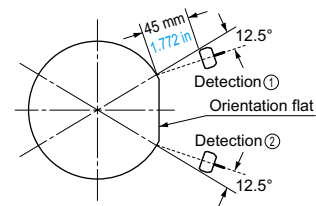



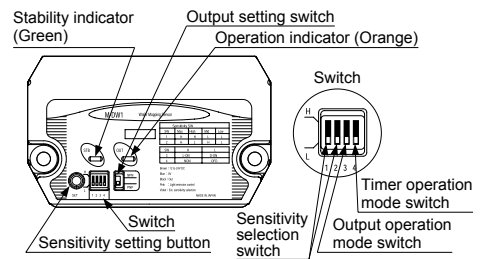

Part description

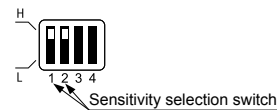

Sensitivity selection setting

- Sensitivity can be selected from four levels by appropriate setting of the sensitivity selection switch (2 bits).



Sensitivity selection switch	Sensitivity	
	Maximum sensitivity (MAX)	Used for low reflectivity wafers with nitride or oxide film processing, or for thin wafers (0.3 to 0.4 mm 0.012 to 0.016 in)
	High sensitivity (HIGH)	Sensitivity between maximum sensitivity and medium sensitivity
	Medium sensitivity (MID)	Used for high reflectivity polished wafers, etc., or for 3 mm 0.118 in wafer pitch
	Low sensitivity (LOW)	Lowest possible sensitivity setting

Notes: 1) In case of 8 inch or less wafers, the wafer pitch, orientation flat or the surface condition may affect the sensing.
 2) Polished wafers, etc., which have a sharp edge cannot be detected since they do not reflect the light in the light receiving direction.

- FIBER SENSORS
- LASER SENSORS
- PHOTO-ELECTRIC SENSORS
- MICRO PHOTO-ELECTRIC SENSORS
- AREA SENSORS
- SAFETY LIGHT CURTAINS / SAFETY COMPONENTS
- PRESSURE / FLOW SENSORS
- INDUCTIVE PROXIMITY SENSORS
- PARTICULAR USE SENSORS
- SENSOR OPTIONS
- SIMPLE WIRE-SAVING UNITS
- WIRE-SAVING SYSTEMS
- MEASUREMENT SENSORS
- STATIC CONTROL DEVICES
- LASER MARKERS
- PLC
- HUMAN MACHINE INTERFACES
- ENERGY MANAGEMENT SOLUTIONS
- FA COMPONENTS
- MACHINE VISION SYSTEMS
- UV CURING SYSTEMS
- Selection Guide
- Liquid Leak Detection
- Liquid Level Detection
- Water Detection
- Color Mark Detection
- Wafer Detection
- Ultrasonic
- Small / Sim Object Detection
- Obstacle Detection

PRECAUTIONS FOR PROPER USE

Refer to p.1552~ for general precautions.

External sensitivity selection input

- The external sensitivity selection input (violet) becomes ON when it is connected to 0 to 3 V, or 9 V to +V (26.4 V max.), and becomes OFF when it is kept open or connected to 4 to 8 V.
- If the sensitivity is selected with the external sensitivity selection input, set the sensitivity selection switch as shown in the table below.

Sensitivity selection switch	Ext. sensitivity selection input	Sensitivity
	0 to 3 V, or 9 V to +V (26.4 V max.)	ON Maximum sensitivity (MAX)
	Open, or 4 to 8 V	OFF Medium sensitivity (MID)
	0 to 3 V or 9 V to +V (26.4 V max.)	ON High sensitivity (HIGH)
	Open, or 4 to 8 V	OFF Low sensitivity (LOW)

Note: For details of sensitivity, refer to "Sensitivity selection setting" (p.918).

Sensitivity setting

- Although this sensor has an optical system which makes it difficult for the background to affect the detection, the background may have an effect when detecting small diameter wafers. Hence, if the background gets detected, or the stability indicator (green) lights off when the cassette has no wafers, sensitivity setting should be done so that the background does not have an effect. However, the sensitivity reduces when sensitivity setting is done.
- Since the sensitivity is stored in an EEPROM when the sensitivity setting button is pressed, the setting need not be repeated when the power is switched on again. However, note that the EEPROM has a lifetime and its guaranteed life is 100,000 write operation cycles.

Light emission control function

- Light emission is halted when the external light emission control input (pink) is connected to 0 to 3 V, or 9 V to +V (26.4 V max.). In this case, the output turns to the dark state.

Time chart

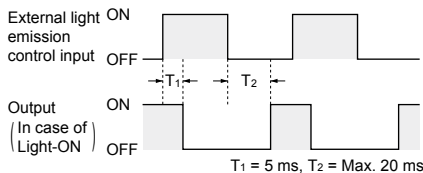

Timer function

- Using the timer operation mode switch, it is possible to select an approx. 2 ms fixed OFF-delay timer. Since the output is extended by a fixed period, it is useful when the connected device has a slow response time.

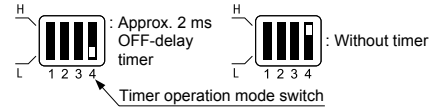

Time chart

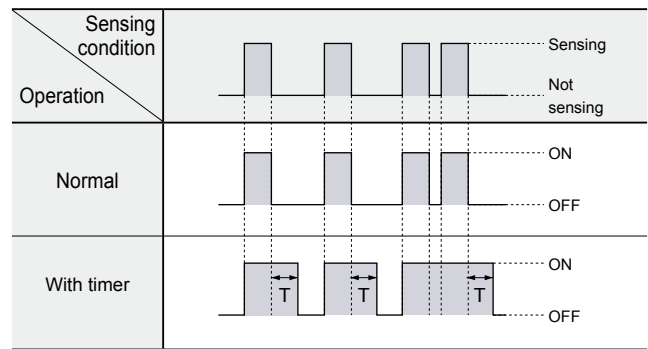

Timer period: T = Approx. 2 ms

Sensing signal

Sensing signal width

- The sensing signal which is output from the sensor is as follows:
 - The sensing signal has a width larger than the thickness of the wafer.
 - The signal width also varies with the reflectivity of the sensing edge. High reflectivity (polish, aluminum evaporated, etc.): Large signal width
 Example: Wafer thickness $t = 0.6 \text{ mm } 0.024 \text{ in}$ → Signal width $1.5 \text{ mm } 0.059 \text{ in approx.}$
 Low reflectivity (nitride or oxide film processed): Small signal width
 Example: Wafer thickness $t = 0.6 \text{ mm } 0.024 \text{ in}$ → Signal width $1.1 \text{ mm } 0.043 \text{ in approx.}$
 - The signal width also changes with the sensing distance or the sensing angle.

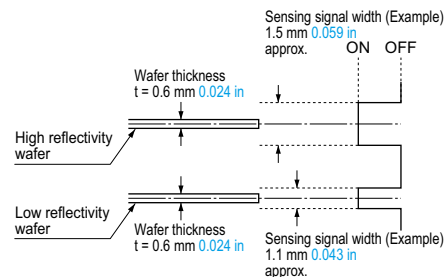

- From the above, for determining the position of the wafer from the sensing signal, calculate the center position of the signal's ON region, while taking into consideration the response time.

PRECAUTIONS FOR PROPER USE

Refer to p.1552~ for general precautions.

Narrow pitch sensing signal width

- In case of “**Detecting wafer having orientation flat**” (p.918), when the sensor is mounted at positions which avoid the wafer orientation flat, the pitch of a cross-condition wafer changes as shown in the figure below.

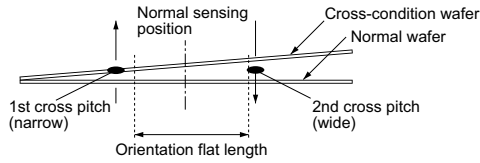

- The calculated pitch based on the wafer size is given in the table below.

Wafer size	Normal pitch	Orientation flat length	Wafer thickness	Cross pitch (narrow)	Cross pitch (wide)
3 inch (75 mm)	4.75 mm 0.187 in	22.2 mm 0.874 in	0.380 mm 0.015 in	1.58 mm 0.062 in	3.17 mm 0.125 in
4 inch (100 mm)	4.75 mm 0.187 in	32.5 mm 1.280 in	0.625 mm 0.025 in	1.54 mm 0.061 in	3.21 mm 0.126 in
5 inch (125 mm)	4.75 mm 0.187 in	42.5 mm 1.673 in	0.625 mm 0.025 in	1.52 mm 0.060 in	3.23 mm 0.127 in
6 inch (150 mm)	4.75 mm 0.187 in	57.5 mm 2.264 in	0.675 mm 0.027 in	1.43 mm 0.056 in	3.33 mm 0.131 in
8 inch (200 mm)	6.35 mm 0.250 in	59.3 mm 2.335 in	0.725 mm 0.029 in	2.19 mm 0.086 in	4.16 mm 0.164 in

- From the above, it is seen that, since the pitch of the cross-condition wafer reduces, the pitch resolution required for high reflectivity wafers becomes more stringent than the specified resolution of 3 mm 0.118 in. Hence, the sensing signal from two wafers may not be resolved and may become a continuous signal. Further, the sensing signal may also change due to the sensitivity setting, the reflectivity of the wafer, and the sensing conditions (sensing distance or sensing angle). For the above reasons, in case of wafers which have been cross-inserted, since the small cross-pitch side is similar to overlapping wafers, the sensing signal of two wafers may become a continuous signal or may get resolved.
- If the orientation flat happens to get in the position of sensing, sensing is not possible in one of the two sensing positions. Therefore, if the wafer is cross-inserted, a resolved signal may not be output, and in this case, the information on the wafer position calculated from the sensing signal will be erroneous.

DIMENSIONS (Unit: mm in)

The CAD data can be downloaded from our website.

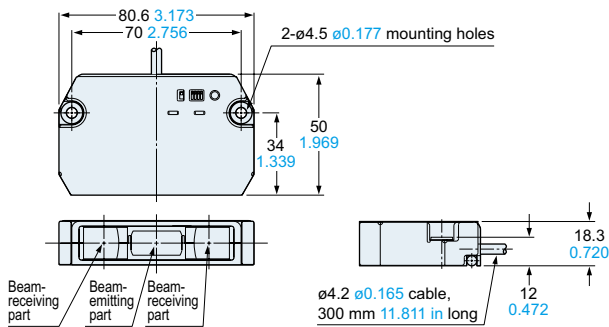

- FIBER SENSORS
- LASER SENSORS
- PHOTO-ELECTRIC SENSORS
- MICRO PHOTO-ELECTRIC SENSORS
- AREA SENSORS
- SAFETY LIGHT CURTAINS / SAFETY COMPONENTS
- PRESSURE / FLOW SENSORS
- INDUCTIVE PROXIMITY SENSORS
- PARTICULAR USE SENSORS
- SENSOR OPTIONS
- SIMPLE WIRE-SAVING UNITS
- WIRE-SAVING SYSTEMS
- MEASUREMENT SENSORS
- STATIC CONTROL DEVICES
- LASER MARKERS
- PLC
- HUMAN MACHINE INTERFACES
- ENERGY MANAGEMENT SOLUTIONS
- FA COMPONENTS
- MACHINE VISION SYSTEMS
- UV CURING SYSTEMS
- Selection Guide
- Liquid Leak Detection
- Liquid Level Detection
- Water Detection
- Color Mark Detection
- Wafer Detection
- Ultrasonic
- Small / Slim Object Detection
- Obstacle Detection