

THIS DOCUMENT IS SUBJECT TO CHANGE WITHOUT NOTICE. IT IS CONFIDENTIAL AND A PROPERTY OF Amphenol LTW. DISCLOSURE TO THIRD PARTY HAS TO BE AUTHORIZED BY Amphenol LTW.

REV.	ECN NO.	DATE	SIGN	DESCRIPTION
C	LEN1650262~273	2016/04/25	Joyy	Modify The Wire Cross Section
D	LEN1681124~135	2016/07/12	Joyy	Modify The Size Of The Red Seal
E	LEN1690117~128	2016/09/10	Joyy	Modify the packaging and quantity

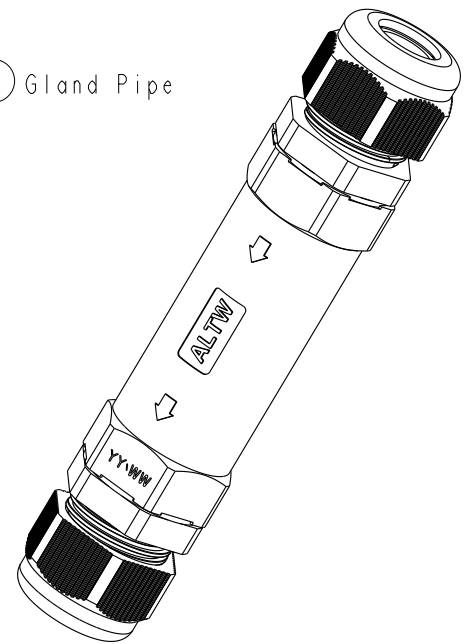
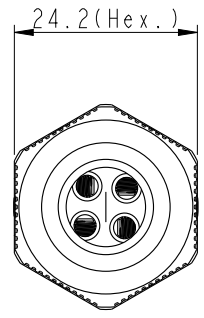
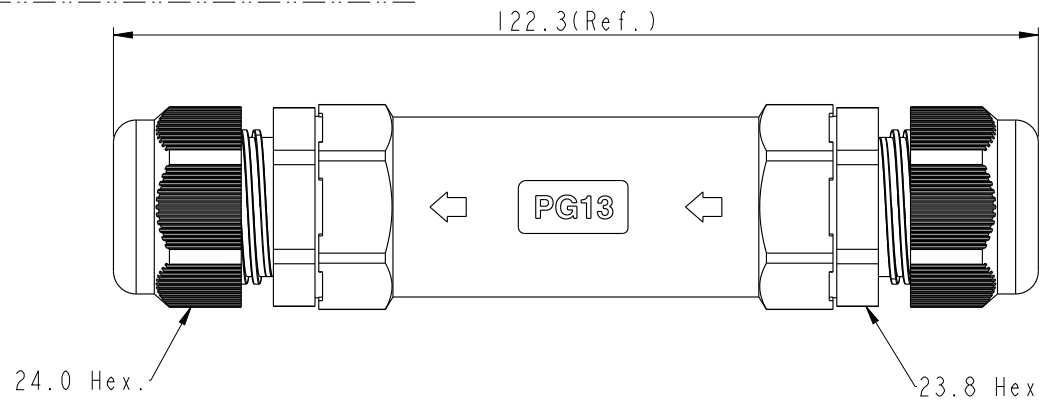
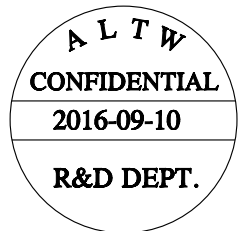
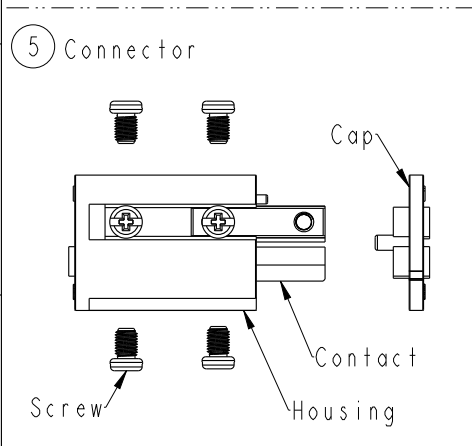
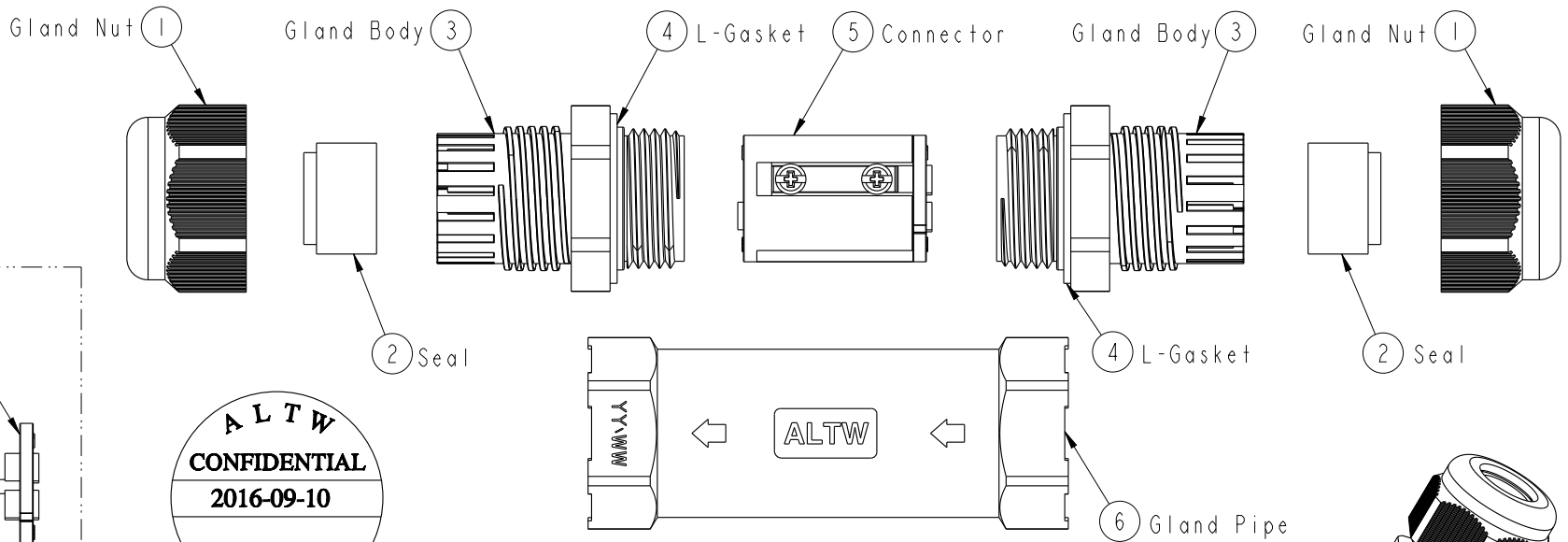

UNIT: mm	
TOLERANCE	
.X	±0.25
.XX	±0.1
.XXX	±0.05
ANGLES	±1°

TITLE PG13 Cable Joiner Screw-in Type			
SCALE 1:1	SIZE A4	SHEET 1 OF 2	
REV. E	WC-REV. A.8	☉: Inspection item	

**Amphenol LTW**  
安費諾亮泰企業股份有限公司

ITEM NO.	DRAWN BY Joyy	DATE 2016-09-10
DWG NO. SC-L-PG13-XX-XX	CHECKED BY Ma Fei	DATE 2016-09-10
CUSTOMER ALTW	APPROVED BY Jerry	DATE 2016-09-10

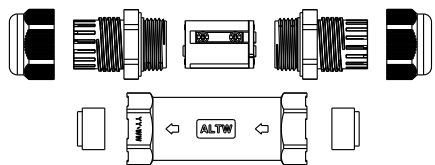

QTY: 1PCS

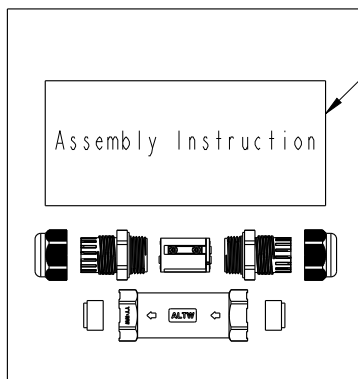
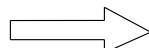

QTY: 105PCS

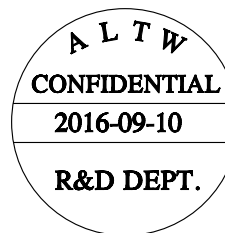
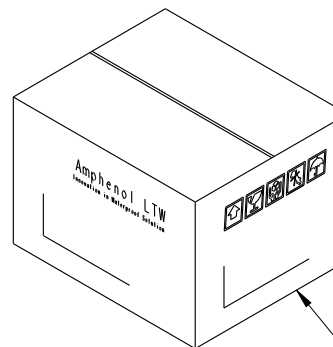
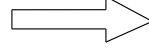

9 Carton

Both A Unassembled product And An Instruction Are In A PE Bag.  
(將一套未組裝的產品和說明書, 放置於一個PE袋, 並封口)



Note:

- \*  $\varnothing$  Important Dimension To Check.
- \* Waterproof Rate: IP68 (50M,24H)
- \* Housing & Cap: PA66+GF, Black.
- \* Gland Pipe: PA66, Black.
- \* Gland Body: PA66, Black.
- \* Gland Nut: PA6+GF, Black.
- \* Contact: Brass, Nickel Plated
- \* L-Gasket : Silicone, Yellow.
- \* Seal: Silicone, Blue & Yellow & Green & Red.
- \* Rated Voltage: 2~4 Pole 450V AC
- \* Rated Current: 2 & 3 Pole Max. 20A ,  
4 Pole Max. 15A.
- \* Operating Temperature: -40°~+105°.
- \* Gland Pipe Recommended Tightening Torque:  
6~8 Kgf.cm(0.59~0.78 N.m)
- \* Gland Nut Recommended Tightening Torque:  
6~8 Kgf.cm(0.59~0.78 N.m)
- \* Seal For Cable OD:  $\varnothing$  4.5~ $\varnothing$  6.5mm, Blue.  
 $\varnothing$  6.6~ $\varnothing$  8.5mm, Yellow.  
 $\varnothing$  8.6~ $\varnothing$  10.5mm, Green .  
 $\varnothing$  10.6~ $\varnothing$  11.5mm, Red.
- \* Screws for Wire connection recommended tightening torque: 1.29~2.50 kgf.cm / 0.127~0.245 N.m
- \* Applicable Wire gauge (Stranded wire cross section) 0.75mm<sup>2</sup> (18AWG) ~ 2.5mm<sup>2</sup> (14AWG)

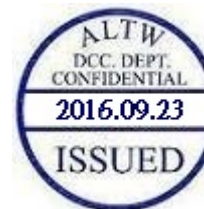

SC-L-PG13-XX-XX  
L:Cable Joiner  
Type: PG13

Seal's Color: BL-Blue(藍色) For Cable Range:  $\varnothing$  4.5~ $\varnothing$  6.5mm

YW-Yellow(黃色) For Cable Range:  $\varnothing$  6.6~ $\varnothing$  8.5mm

GN-Green(綠色) For Cable Range:  $\varnothing$  8.6~ $\varnothing$  10.5mm

RD-Red(紅色) For Cable Range:  $\varnothing$  10.6~ $\varnothing$  11.5mm  $\triangle D$

No. of Conductor: 02-2Poles

03-3Poles

04-4Poles

Pole Assignments Front View

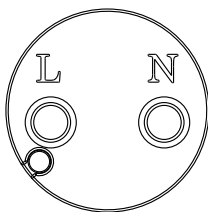

2 Pole

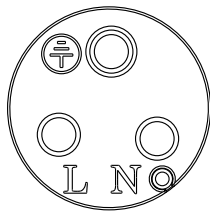

3 Pole

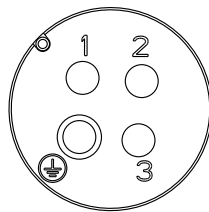

4 Pole

UNIT:mm

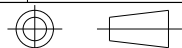

TOLERANCE  
.X ±0.25  
.XX ±0.1  
.XXX ±0.05  
ANGLES ±1°

TITLE

PG13 Cable Joiner  
Screw-in Type

SCALE

1:1

SIZE

A4

SHEET

2

OF

2

REV.

E

WC-REV.

A.8

$\varnothing$ : Inspection item

**Amphenol LTW**

安費諾亮泰企業股份有限公司

ITEM NO

DWG NO

CUSTOMER

SC-L-PG13-XX-XX  
ALTW

DRAWN BY

CHECKED BY

APPROVED BY

Joyy  
Ma Fei  
Jerry

DATE

DATE

DATE

2016-09-10  
2016-09-10  
2016-09-10

2

3

4

5

6

7

8