

15mm potentiometer

SMD

PS-15 & PSX-15

FEATURES

- Specifically designed for leadfree reflow soldering processes (excellent performance).
- Carbon resistive element.
- IP54 protection according to IEC 60529.
- Moisture sensitivity level 1 (PS-15).
- Full traceability.
- Embossed tape according to IEC 60286-3:2007
- Wiper positioned at initial, 50% or fully clockwise.
- Also upon request:
 - Self extinguishable plastic UL 94V-0 (PS-15).
 - Mechanical detents.
 - Locating pins for accurate PCB positioning.
 - Low torque versions.
 - Log/alog and custom tapers.
 - Shafts and knobs.



MECHANICAL SPECIFICATIONS

- Mechanical rotation angle: $265^\circ \pm 5^\circ$
- Electrical rotation angle: $240^\circ \pm 20^\circ$
- Torque: 0.5 to 2.5 Ncm. (0.7 to 3.4 in-oz)
- Stop torque: > 10 Ncm. (>14 in-oz)
- Mechanical life*: up to 100K cycles

* Others: check availability.

ELECTRICAL SPECIFICATIONS

- Value*: 1K Ω to 1M Ω
- Tolerance*: $\pm 30\%$
- Taper*: Linear
- Nominal Power: 0.25W @ 50°C (122°F)
- Operating temperature: PSX-15: $-25^\circ\text{C} + 70^\circ\text{C}$
PS-15: $-40^\circ\text{C} + 85^\circ\text{C}$
- Residual resistance: $\leq 5 \cdot 10^{-3} R_n$
- Equivalent Noise Resistance: $\leq 3\% R_n$

HOW TO ORDER

STANDARD

OPTIONAL EXTRAS

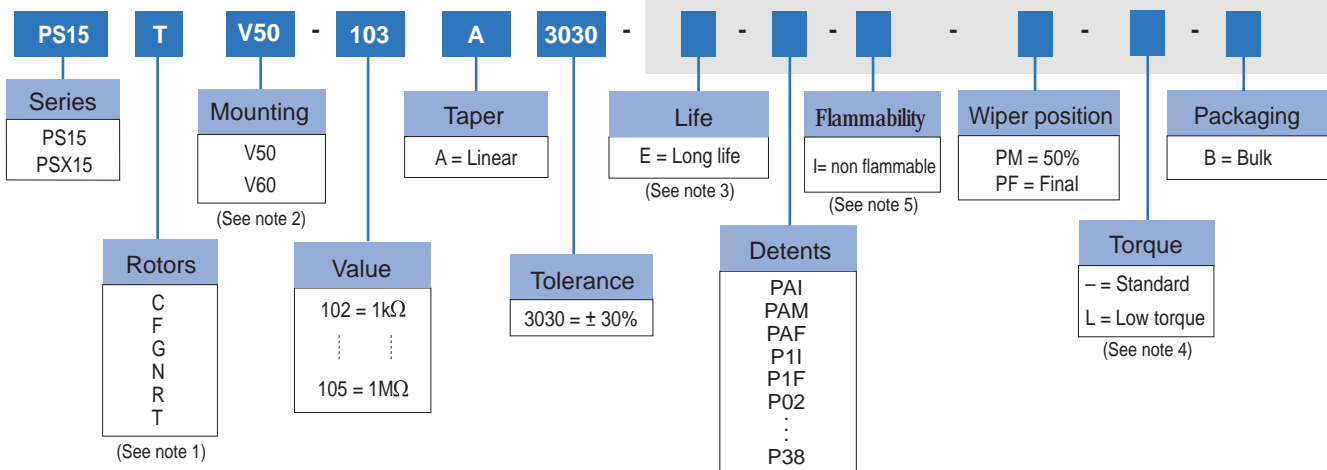

NOTES

- (1) Rotors C and F not available for PSX-15.
- (2) V50: without locating pins.
V60: with locating pins.
- (3) "E" option for PSX-15 only. Higher life available upon request for both models to be studied case by case.
- (4) Low Torque: $\leq 1.5\text{Ncm}$. No detent option available for low torque models
- (5) Non flammable plastic material for housing and rotor.

HOW TO ORDER CUSTOM DRAWING

PS(X)-15 TV50+ DRAWING NUMBER (Max. 16 digits)

This way of ordering should be used for options which are not included in the "How to order" standard and optional extras.

STANDARD/DEFAULT OPTIONS

	PSX-15	PS-15
Detents	None	None
Rotor colour	Black	Grey
Housing colour	Black	Grey
Wiper position	Initial	Initial
Torque	Standard	Standard
Packaging	Reel	Reel
Mechanical Life	1K cycles	10K cycles

ROTORS (collector side view)

Wipers positioned at initial

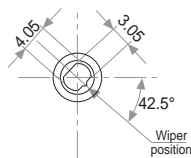

N =
Removable shaft
or thumbwheel

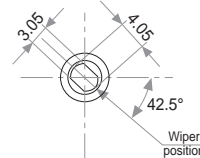

G =
Removable shaft
or thumbwheel

Wipers positioned at 50%

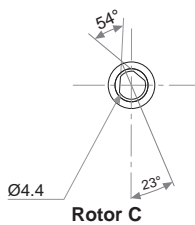

Rotor C

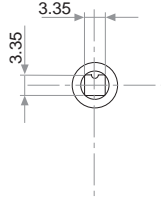

Rotor F

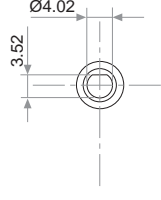

Rotor R

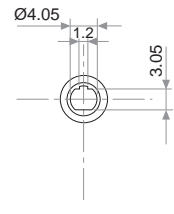

Rotor T

DIMENSIONS (V50 version)

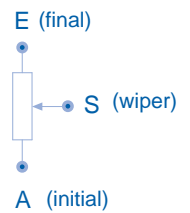
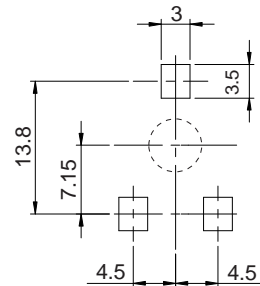
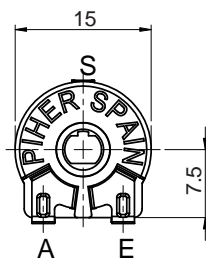
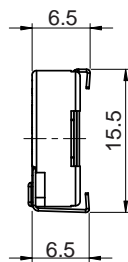
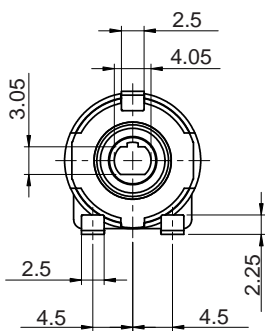

DIMENSIONS (V60 version - with centering pins)

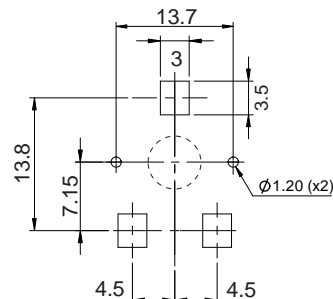
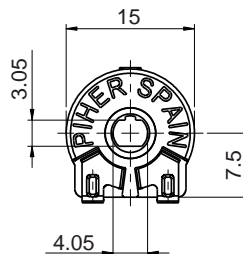
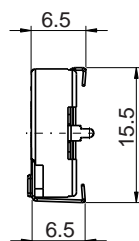
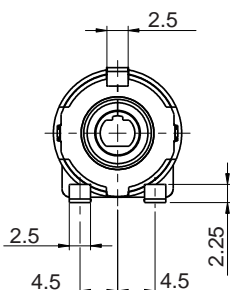

POSITIONING

Default position = CCW

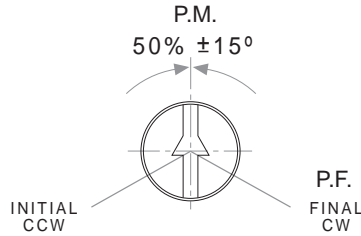

PSX-15 RECOMMENDED REFLOW PROFILE

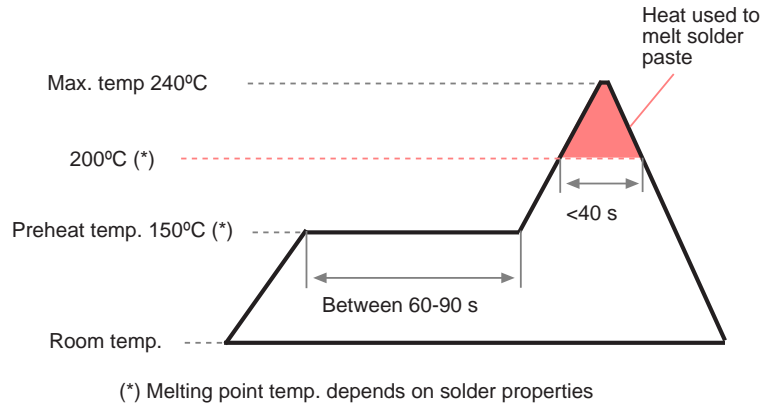

The recommended reflow profile is provided as a guideline. Optimal profile may differ due to oven type, assembly layout or other design or process variables. Customers should verify actual device performance in their specific application and reflow process. Please contact Piher if you require additional support.

PSX-15 TESTS

VARIATIONS

ELECTRICAL LIFE	1000 h. @ 50°C; 0.25 W	±10 %
MECHANICAL LIFE*	1k @ 10 CPM ...15 CPM	±10 %
TEMPERATURE COEFFICIENT	-25°C; +70°C	±1000 ppm
THERMAL CYCLING	16 h. @ 85°C; 2h. @ -25°C	±5 %
DAMP HEAT	500 h. @ 40°C @ 95% HR	±15 %
VIBRATION (for each plane X,Y,Z)	2 h. @ 10 Hz. ... 55 Hz.	±3 %

* Tests at room temperature. Other life cycles upon request.

NOTE: Out of range values may not comply these results. Please confirm with the factory all the information before designing in.

PS-15 RECOMMENDED REFLOW PROFILE

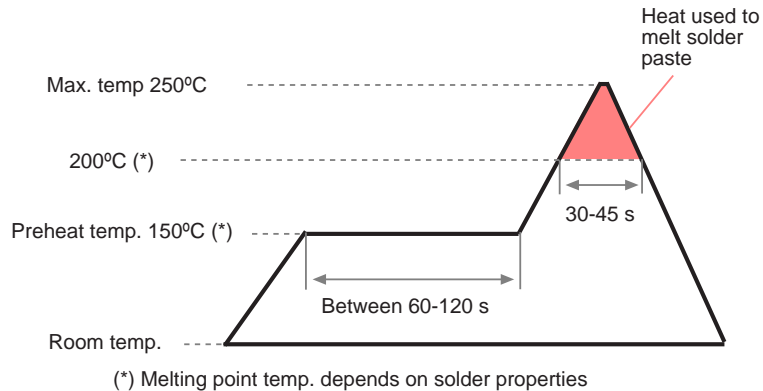

The recommended reflow profile is provided as a guideline. Optimal profile may differ due to oven type, assembly layout or other design or process variables. Customers should verify actual device performance in their specific application and reflow process. Please contact Piher if you require additional support.

PS-15 TESTS

VARIATIONS

ELECTRICAL LIFE	1000 h. @ 50°C; 0.25 W	±10 %
MECHANICAL LIFE	10k @ 10 CPM ...15 CPM	±10 %
TEMPERATURE COEFFICIENT	-40°C; +85°C	±1500 ppm
	-25°C; +70°C	±1000 ppm
THERMAL CYCLING	16 h. @ 90°C; 2h. @ -40°C	±5 %
DAMP HEAT	500 h. @ 40°C @ 95% HR	±15 %
VIBRATION (for each plane X,Y,Z)	2 h. @ 10 Hz. ... 55 Hz.	±3 %

* Tests at room temperature. Other life cycles upon request.

NOTE: Out of range values may not comply these results. Please confirm with the factory all the information before designing in.

PACKAGING

BULK: 500pcs per box (80 x 85 x 185 mm.).

EMBOSSED TAPE: 400pcs per reel.

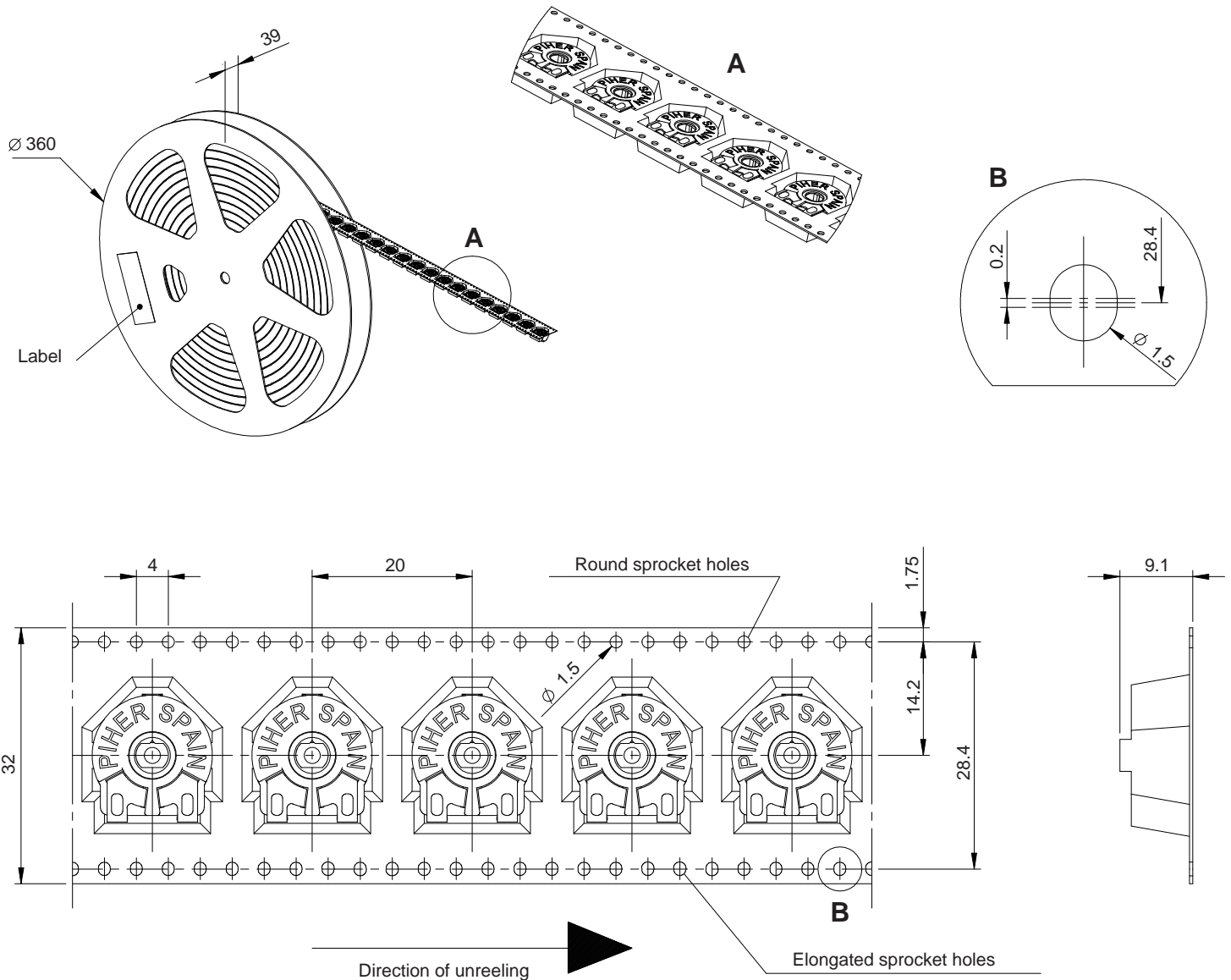

DETENT CONFIGURATIONS EXAMPLES

This innovative PT's with detents family has been specifically developed to allow the integration of otherwise large and expensive external mechanisms into the body of the potentiometer thus allowing a high range of configurations: special tapers, torque, tolerances, linearity, cut track, etc.

This detent design not only adds a "click" sensation of position, but also offers enormous savings in both cost and space for any given application.

Detent number and positions can be made or fitted to the customer needs or preferences.

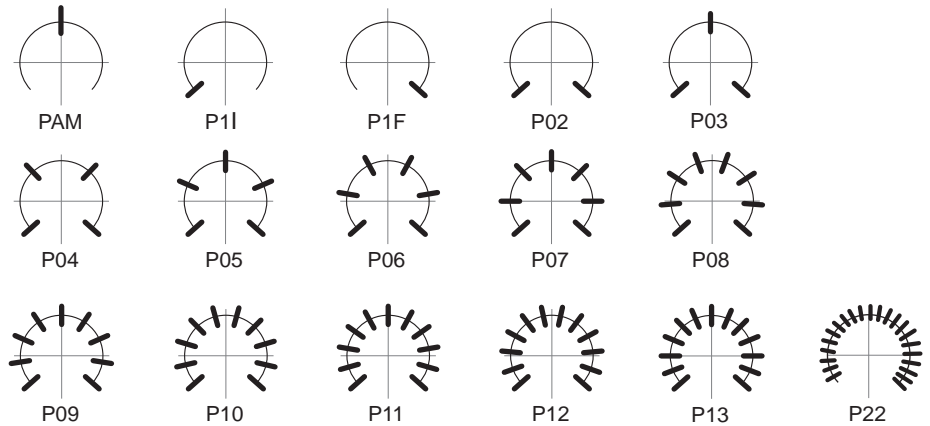

NOTES FOR DETENTED VERSIONS:

- (1) Some configurations may have a longer leadtime.
- (2) Standard mechanical life is 500 cycles.
- (3) Long life versions are available under request and have the following characteristics at T^a:
 - Potentiometers with 1 to 3 detents: up to 10K cycles
 - Potentiometers with 4 and more detents: up to 5K cycles
- (4) Detent torque can vary from 1.2 to 2.5 times the standard potentiometer torque.
- (5) Please consult your nearest Piher supplier if unique non-overlapping values at each detent position or LOG/ALOG tapers are required.
- (6) Different output voltage values can be matched at each detent position (under request).

— Relative detent positions along the total mechanical travel. Unless otherwise specified the detents are evenly spaced (using the end points as reference)

RECOMMENDED CONNECTIONS

Piher potentiometer's recommended connection circuit for a position sensor or control application. (voltage divider circuit electronic design).

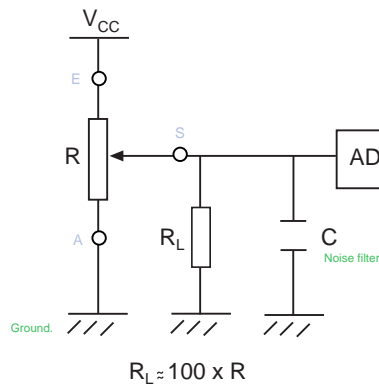

Disclaimer

The product information in this catalogue is for reference purposes. Please consult for the most up to date and accurate design information.

Piher Sensors & Controls S.A., its affiliates, agents, and employees, and all persons acting on its or their behalf (collectively, "Piher"), disclaim any and all liability for any errors, inaccuracies or incompleteness contained herein or in any other disclosure relating to any product described herein.

Piher disclaims any and all liability arising out of the use or application of any product described herein or of any information provided herein to the maximum extent permitted by law. The product specifications do not expand or otherwise modify Piher's terms and conditions of sale, including but not limited to the warranty expressed therein, which apply to these products.

No licence, express or implied, by estoppel or otherwise, to any intellectual property rights is granted by this document or by any conduct of Piher.

The products shown herein are not designed for use in medical, life-saving, or life-sustaining applications unless otherwise expressly indicated. Customers using or selling Piher products not expressly indicated for use in such applications do so entirely at their own risk and agree to fully indemnify Piher for any damages arising or resulting from such use or sale. Please contact authorised Piher personnel to obtain written terms and conditions regarding products designed for such applications.

Product names and markings noted herein may be trademarks of their respective owners.

All Piher products can be adapted to meet customer's requirements. Please always use the latest updated datasheets published at our website www.piher.net.

Information contained in and/or attached to this catalogue may be subject to export control regulations of the European Community, USA, or other countries. Each recipient of this document is responsible to ensure that usage and/or transfer of any information contained in this document complies with all relevant export control regulations. If you are in any doubt about the export control restrictions that apply to this information, please contact the sender immediately. For any Piher Exports, Note: All products / technologies are EAR99 Classified commodities. Exports from the United States are in accordance with the Export Administration Regulations. Diversion contrary to US law is prohibited.

