

TWTZ-05040

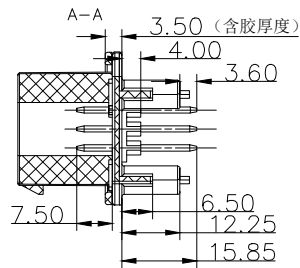

SECTION A-A

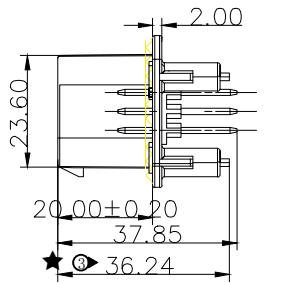
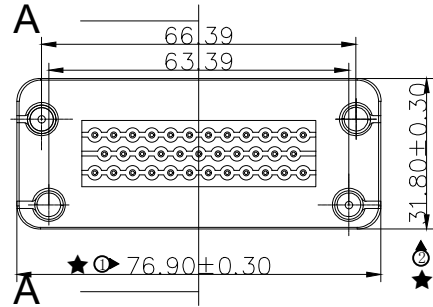
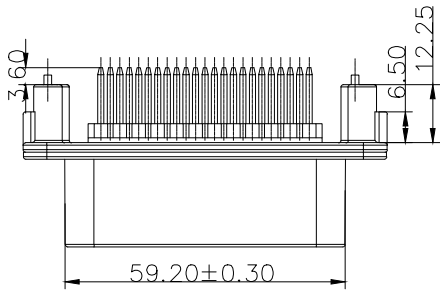
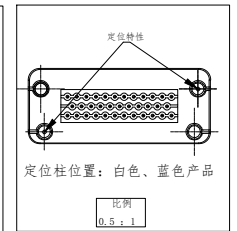
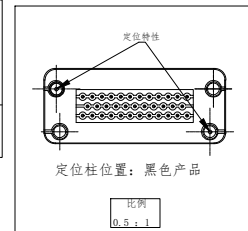
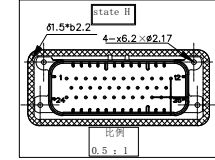
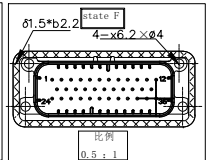
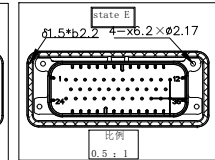
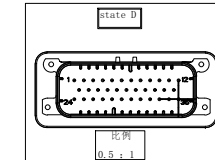
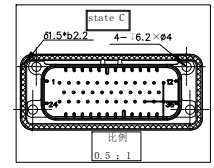
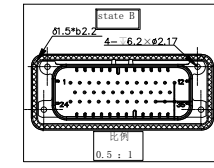
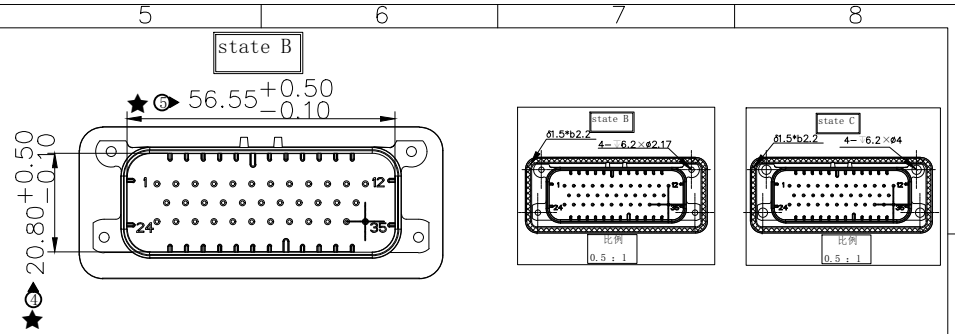
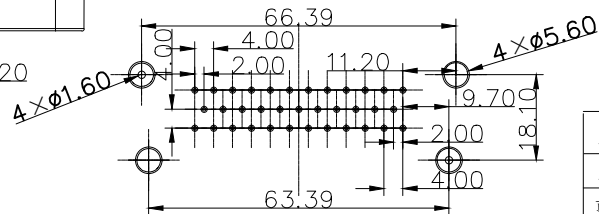
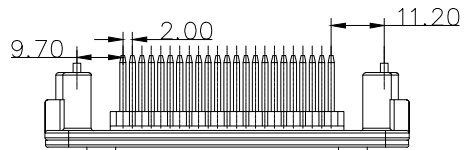

状态state	颜色 colour	型号 model	规格 Specifications	图标 Icon
加胶加螺	白white	JHB00426		state F
无胶无螺	白white	JHB00448	776230-2	state D
加胶无螺	白white	JHB00408	776231-2	state E
加胶无螺 (镀金端子)	白white	JHB00440	1-776231-1	state E
加胶加螺	黑black	JHB00372		state C
无胶无螺	黑black	JHB00376	776230-1	state A
加胶无螺	黑black	JHB00365	776231-1	state B
加胶无螺 (镀金端子)	黑black	JHB00436	1-776231-1	state B
加胶无螺	蓝blue	JHB00467	776231-5	state H

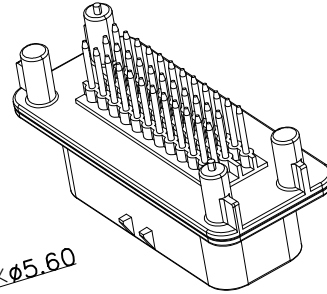

尺寸范围	0~5	5~20	20~45	45~70	70~100	100~250	≥250	角度
未注公差	±0.15	±0.2	±0.3	±0.4	±0.5	±0.7	±1.5	±2°
更改单号	更改内容	版本号	签名	年月日	河南金华电气有限公司			
制图	秦艳红	2022.06.6	S					
工艺					阶段标记	重量	比例	名称
审核	芦红玲	2022.07.11			共1张第1张	版本	Z-A	编码
批准								型号
								35P连接器(直针)
								图号
								TWTZ-05041
								编码
								JHB00365(加胶无螺)
								型号
								776231-1

- 技术要求:
1. 塑料材质: PBT+GF15+VO、插针材质: 铜镀锡
  2. 内外表面光洁, 表面无飞边、毛刺、缩坑等不良缺陷;
  3. 插针无漏装、回退、歪斜等不良缺陷
  4. 重要尺寸用★标记, 共5处;
  5. 考虑模具浇注口位置及形状对产品外观性状的影响。
  6. 未注公差按GB/T 1804-92 m级。

描 稿
旧底图总号
底图总号
签 字
日 期