

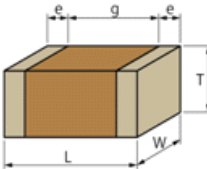

< List of part numbers with package codes >
 GJM1555C1H6R2FB01D , GJM1555C1H6R2FB01W , GJM1555C1H6R2FB01J

Shape



L size	1.0 ±0.05mm
W size	0.5 ±0.05mm
T size	0.5 ±0.05mm
External terminal width e	0.15 to 0.35mm
Distance between external terminals g	0.3mm min.
Size code in inch(mm)	0402 (1005M)

References

Packaging	Specifications	Minimum quantity
D	φ180mm Paper taping	10000
J	φ330mm Paper taping	50000
W	φ180mm Paper taping (W8P1*) * Width : 8mm, Pocket pitch : 1mm	20000

Mass (typ.)	
1 piece	1.6mg
φ180mm Reel	118g

Specifications

Capacitance	6.2pF ±1%
Rated voltage	50Vdc
Temperature characteristics (complied standard)	C0G(EIA)
Temperature coefficient	0±30ppm/°C
Temperature range of temperature characteristics	25 to 125°C
Operating temperature range	-55 to 125°C

Attention

- 1.This datasheet is downloaded from the website of Murata Manufacturing Co., Ltd. Therefore, it's specifications are subject to change or our products in it may be discontinued without advance notice. Please check with our sales representatives or product engineers before ordering.
- 2.This datasheet has only typical specifications because there is no space for detailed specifications. Therefore, please review our product specifications or consult the approval sheet for product specifications before ordering.