

Features

- High Efficiency (Up to 90.5%)
- Full Power at Wide Output Current Range (Constant Power)
- 0-10V/PWM/3-Timer-Modes Dimmable
- Dim-to-Off with Standby Power ≤ 1.5 W
- Output Lumen Compensation
- Input Surge Protection: 4kV line-line, 6kV line-earth
- All-Around Protection: OVP, SCP, OTP
- Waterproof (IP67) and UL Dry / Damp / Wet Location
- Class 2 & SELV Output
- TYPE HL, for use in a Class I, Division 2 hazardous (Classified) location
- 5 Years Warranty



Description

The ESD-096SxxxDT series is a 96W, constant-current, programmable LED driver that operates from 249-528 Vac input with excellent power factor. Created for many lighting applications including low bay, area and street, it provides a dim-to-off mode with low standby power. The high efficiency of these drivers and compact metal case enables them to run cooler, significantly improving reliability and extending product life. To ensure trouble-free operation, protection is provided against input surge, output over voltage, short circuit, and over temperature.

Models

Adjustable Output Current Range	Full-Power Current Range (1)	Default Output Current	Input Voltage Range(2)	Output Voltage Range	Max. Output Power	Typical Efficiency (3)	Power Factor		Model Number
							277Vac	480Vac	
45-900mA	450-900mA	700 mA	249~528 Vac 352~500 Vdc	64~214Vdc	96 W	90.5%	0.98	0.95	ESD-096S090DT
90-1800mA	900-1800mA	1050 mA	249~528 Vac 352~500 Vdc	32~107Vdc	96 W	90.5%	0.98	0.95	ESD-096S180DT ⁽⁴⁾
180-3600mA	1800-3600mA	2100 mA	249~528 Vac 352~500 Vdc	16 ~ 53Vdc	96 W	89.5%	0.98	0.95	ESD-096S360DT ⁽⁵⁾

- Notes:** (1) Output current range with constant power at 96W
 (2) Certified voltage range: 277-480Vac or 352-500Vdc.
 (3) Measured at 100% load and 480Vac input (see below "General Specifications" for details).
 (4) SELV Output
 (5) Class 2 & SELV Output

I-V Operating Area

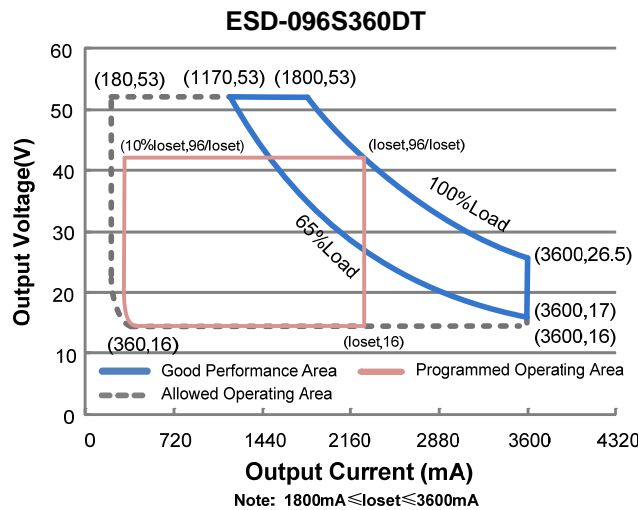
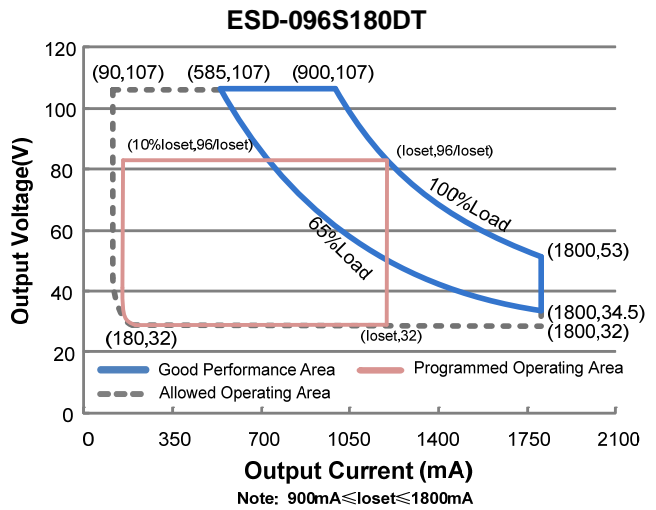
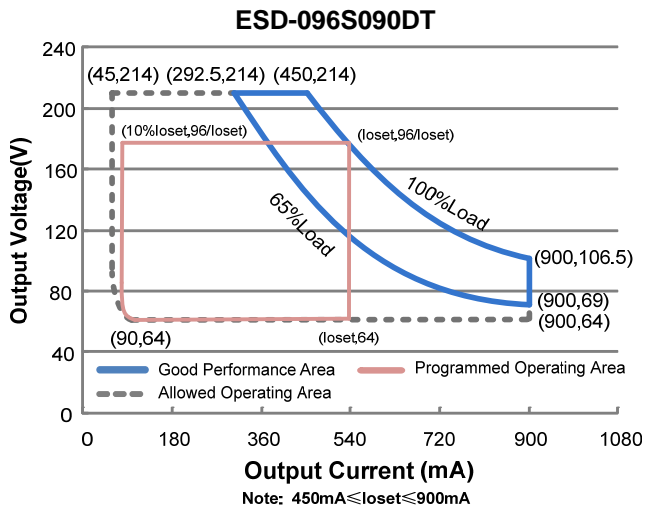

Input Specifications

Parameter	Min.	Typ.	Max.	Notes
Input Voltage	249 Vac	-	528 Vac	352-500Vdc
Input Frequency	47 Hz	-	63 Hz	
Leakage Current	-	-	0.75 MIU	UL8750; 480Vac/ 60Hz; Grounding effectively.
	-	-	0.70 mA	IEC60598-1; 480Vac/ 60Hz; Grounding effectively.
Input AC Current	-	-	0.48A	Measured at 100% load and 277 Vac input.
	-	-	0.30A	Measured at 100% load and 480 Vac input.
Inrush Current(I ² t)	-	-	2.17 A ² s	At 480Vac input, 25°C Cold Start, Duration=500 μs, 10%Ipk-10%Ipk. See Inrush Current Waveform for the details.

Input Specifications (Continued)

Parameter	Min.	Typ.	Max.	Notes
PF	0.90	-	-	At 277-480Vac, 50-60Hz, 65%-100% Load (63-96W)
THD	-	-	20%	

Output Specifications

Parameter	Min.	Typ.	Max.	Notes
Output Current Tolerance	-5%loset	-	5%loset	At 100% load condition
Output Current Setting(loset) Range				
ESD-096S090DT	45 mA	-	900 mA	
ESD-096S180DT	90 mA	-	1800 mA	
ESD-096S360DT	180 mA	-	3600 mA	
Output Current Setting Range with Constant Power				
ESD-096S090DT	450 mA	-	900 mA	
ESD-096S180DT	900 mA	-	1800 mA	
ESD-096S360DT	1800 mA	-	3600 mA	
Total Output Current Ripple (pk-pk)	-	5%lomax	10%lomax	At 100% load condition
Output Current Ripple at < 200 Hz (pk-pk)	-	1%lomax	-	At 100% load condition.
Startup Overshoot Current	-	-	10%lomax	At 100% load condition
No-load Output Voltage				
ESD-096S090DT	-	-	240V	
ESD-096S180DT	-	-	119V	
ESD-096S360DT	-	-	59.5V	
Line Regulation	-	-	± 0.5%	Measured at 100% load
Load Regulation	-	-	± 1.5%	
Turn-on Delay Time	-	0.5 s	0.75 s	Measured at 277Vac and 480Vac input , 65%-100%Load
Temperature Coefficient of loset	-	0.03%/°C	-	Case temperature = 0°C ~Tc max
12V Auxiliary Output Voltage	10.8 V	12 V	13.2 V	
12V Auxiliary Output Source Current	0 mA	-	200 mA	Return terminal is "Dim"

General Specifications

Parameter	Min.	Typ.	Max.	Notes
Efficiency at 277 Vac input: ESD-096S090DT Io=450 mA Io=900 mA ESD-096S180DT Io=900 mA Io=1800mA ESD-096S360DT Io=1800mA Io=3600mA	87.5% 87.5% 87.5% 87.0% 86.0% 85.0%	89.5% 89.5% 89.5% 89.0% 88.0% 87.0%	- - - - - -	Measured at 100% load and steady-state temperature in 25°C ambient; (Efficiency will be about 2.0% lower if measured immediately after startup.)
Efficiency at 347 Vac input: ESD-096S090DT Io=450 mA Io=900 mA ESD-096S180DT Io=900 mA Io=1800mA ESD-096S360DT Io=1800mA Io=3600mA	88.0% 88.0% 88.0% 87.5% 87.0% 86.0%	90.0% 90.0% 90.0% 89.5% 89.0% 88.0%	- - - - - -	Measured at 100% load and steady-state temperature in 25°C ambient; (Efficiency will be about 2.0% lower if measured immediately after startup.)
Efficiency at 480 Vac input: ESD-096S090DT Io=450 mA Io=900 mA ESD-096S180DT Io=900 mA Io=1800mA ESD-096S360DT Io=1800mA Io=3600mA	88.5% 88.5% 88.5% 88.0% 87.5% 86.0%	90.5% 90.5% 90.5% 90.0% 89.5% 88.0%	- - - - - -	Measured at 100% load and steady-state temperature in 25°C ambient; (Efficiency will be about 2.0% lower if measured immediately after startup.)
Standby power	-	-	1.5 W	Measured at 480Vac/60Hz; Dimming off
MTBF	-	211,000 Hours	-	Measured at 480Vac input, 80%Load and 25°C ambient temperature (MIL-HDBK-217F)
Lifetime	-	108,000 Hours	-	Measured at 480Vac input, 80%Load and 70°C case temperature; See lifetime vs. Tc curve for the details
Operating Case Temperature for Safety Tc_s	-40°C	-	+90°C	
Operating Case Temperature for Warranty Tc_w	-40°C	-	+75°C	Case temperature for 5 years warranty
Storage Temperature	-40°C	-	+85°C	Humidity: 5%RH to 100%RH
Dimensions Inches (L x W x H) Millimeters (L x W x H)	8.35 x 2.66 x 1.44 212 x 67.5 x 36.5			With mounting ear 9.41 x 2.66 x 1.44 239 x 67.5 x 36.5
Net Weight	-	1090 g	-	

Dimming Specifications

Parameter		Min.	Typ.	Max.	Notes
Absolute Maximum Voltage on the Vdim (+) Pin		-20 V	-	20 V	
Source Current on Vdim (+) Pin		200 μ A	300 μ A	450 μ A	Vdim(+) = 0 V
Dimming Output Range	ESD-096S090DT ESD-096S180DT ESD-096S360DT	10%loset	-	loset	450mA \leq loset \leq 900mA 900mA \leq loset \leq 1800mA 1800mA \leq loset \leq 3600mA
	ESD-096S090DT ESD-096S180DT ESD-096S360DT	45 mA 90 mA 180 mA	-	loset	45mA \leq loset < 450mA 90mA \leq loset < 900mA 180mA \leq loset < 1800mA
	Recommended Dimming Input Range				
Dim off Voltage		0 V	-	10 V	Default 0-10V dimming mode.
Dim on Voltage		0.4 V	0.55V	0.7 V	
Hysteresis		0.6 V	0.75 V	0.9 V	
PWM_in High Level		-	0.2 V	-	Dimming mode set to PWM in PC interface.
PWM_in Low Level		3 V	-	10 V	
PWM_in Frequency Range		-0.3 V	-	0.6 V	
PWM_in Duty Cycle		200 Hz	-	3 KHz	
PWM Dimming off (Positive Logic)		1%	-	99%	
PWM Dimming on (Positive Logic)		3%	5%	8%	
PWM Dimming off (Negative Logic)		5%	7%	10%	
PWM Dimming on (Negative Logic)		92%	95%	97%	
Hysteresis		90%	93%	95%	
Hysteresis		-	2%	-	

Safety & EMC Compliance

Safety Category	Standard
UL/CUL	UL 8750,UL1310,CAN/CSA-C22.2 No. 250.13,CAN/CSA-C22.2 No. 223-M91
CE	EN 61347-1, EN61347-2-13
EMI Standards	Notes
EN 55015 ⁽¹⁾	Conducted emission Test & Radiated emission Test
EN 61000-3-2	Harmonic current emissions
EN 61000-3-3	Voltage fluctuations & flicker

Safety & EMC Compliance (Continued)

EMI Standards	Notes
FCC Part15 ⁽¹⁾	ANSI C63.4 Class B
	This device complies with Part 15 of the FCC Rules. Operation is subject to the following two conditions: [1] this device may not cause harmful interference, and [2] this device must accept any interference received, including interference that may cause undesired operation.
EMS Standards	Notes
EN 61000-4-2	Electrostatic Discharge (ESD): 8 kV air discharge, 4 kV contact discharge
EN 61000-4-3	Radio-Frequency Electromagnetic Field Susceptibility Test-RS
EN 61000-4-4	Electrical Fast Transient / Burst-EFT
EN 61000-4-5	Surge Immunity Test: AC Power Line: line to line 4 kV, line to earth 6 kV ⁽²⁾
EN 61000-4-6	Conducted Radio Frequency Disturbances Test-CS
EN 61000-4-8	Power Frequency Magnetic Field Test
EN 61000-4-11	Voltage Dips
EN 61547	Electromagnetic Immunity Requirements Applies To Lighting Equipment

- Note:** (1) This LED driver meets the EMI specifications above, but EMI performance of a luminaire that contains it depends also on the other devices connected to the driver and on the fixture itself.
 (2) To perform electric strength (hi-pot) testing, the “GDT ground disconnect” (nut and metal lock sheet) on the driver end-cap should be removed temporarily to prevent the internal gas discharge tube from conducting (as allowed by IEC 60598-1 Clause 10.2). After testing is completed, these items must be reinstalled to restore line-to-earth surge protection and secure the end cap.

Lifetime vs. Case Temperature

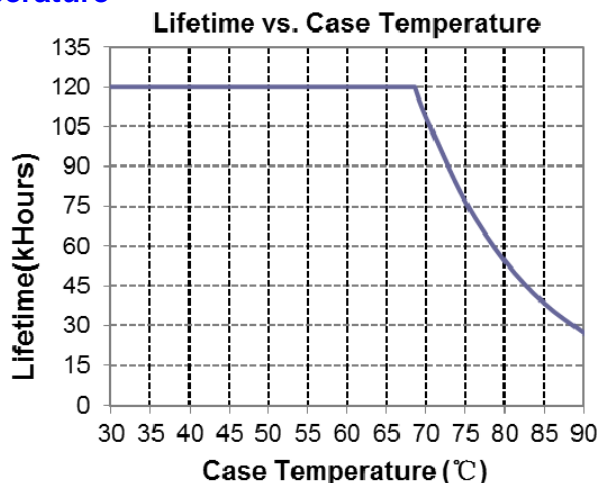

Inrush Current Waveform

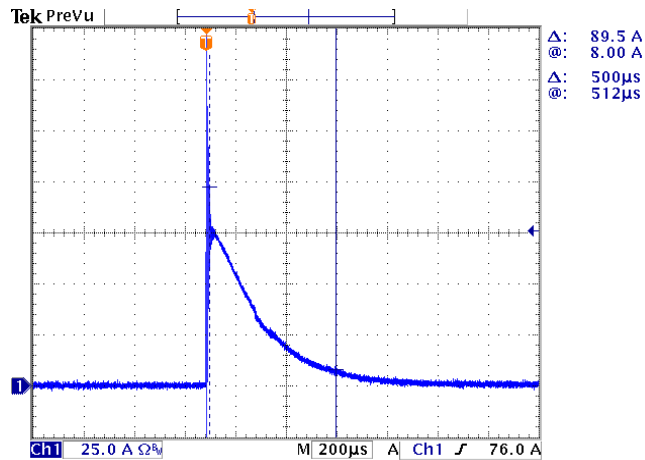

Efficiency vs. Load

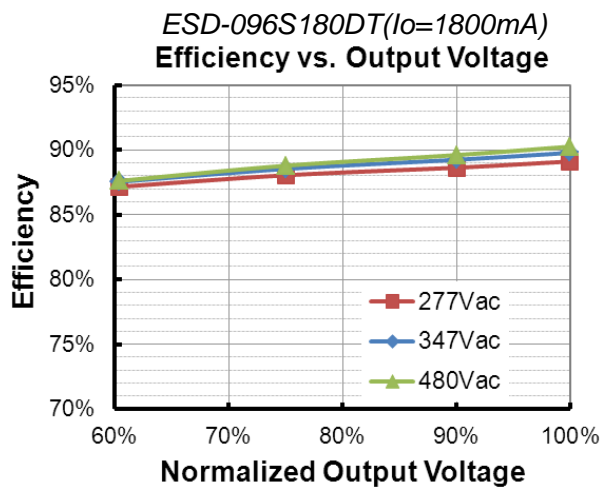
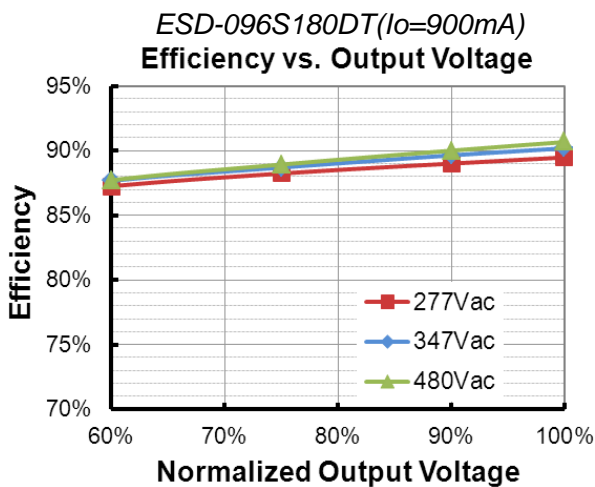
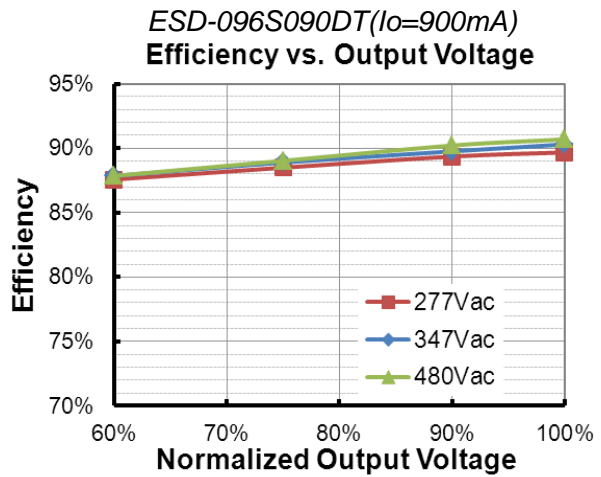
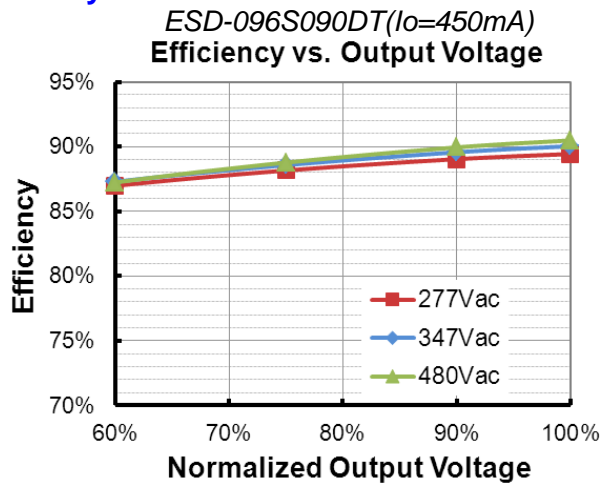

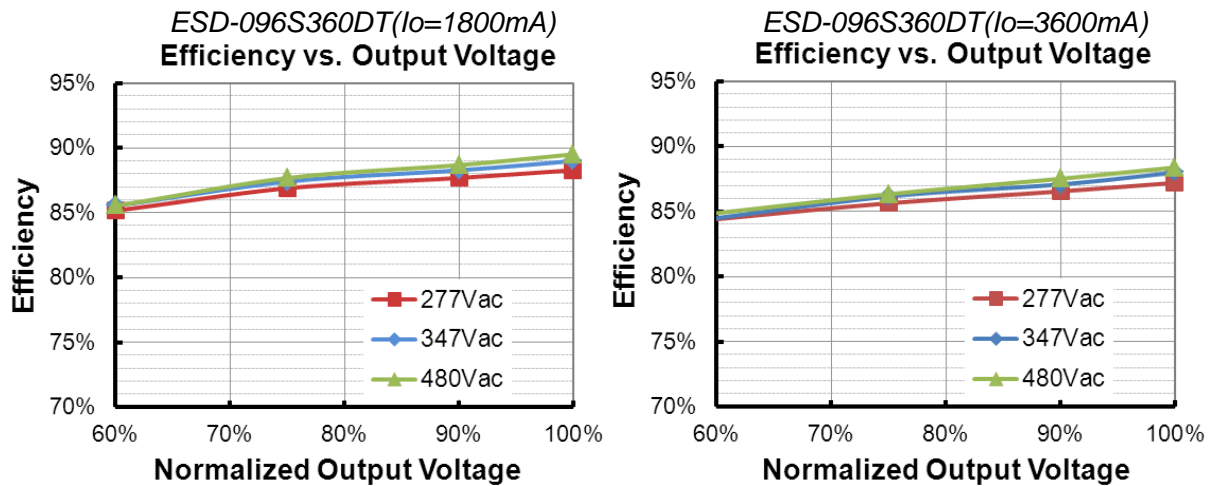

Power Factor

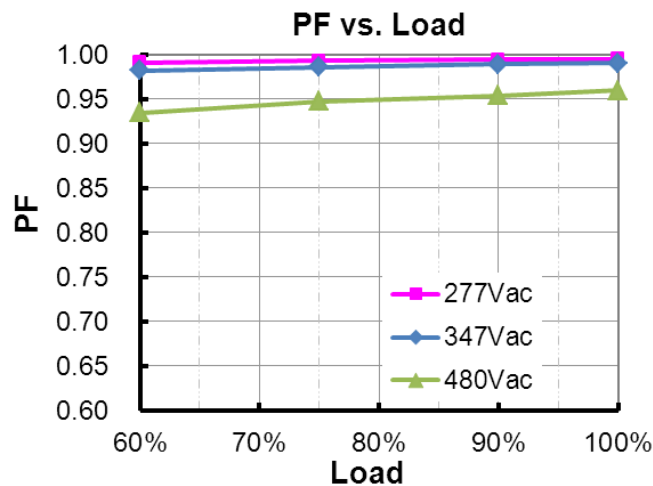

Total Harmonic Distortion

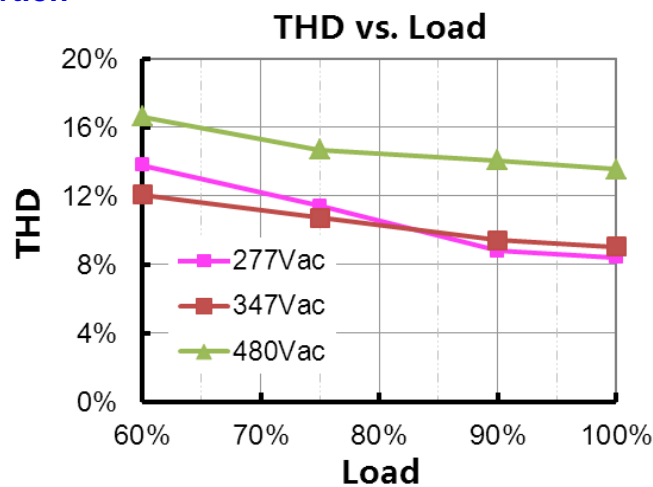

Protection Functions

Parameter	Notes
Over Temperature Protection	Decreases output current, returning to normal after over temperature is removed.
Short Circuit Protection	Auto Recovery. No damage will occur when any output is short circuited. The output shall return to normal within $60 \pm 5s$ after the fault condition is removed.
Over Voltage Protection	Auto Recovery. The power supply shall be self-recovered within $60 \pm 5s$ after the fault condition is removed.

Dimming

● 0-10V Dimming

The recommended implementation of the dimming control is provided below.

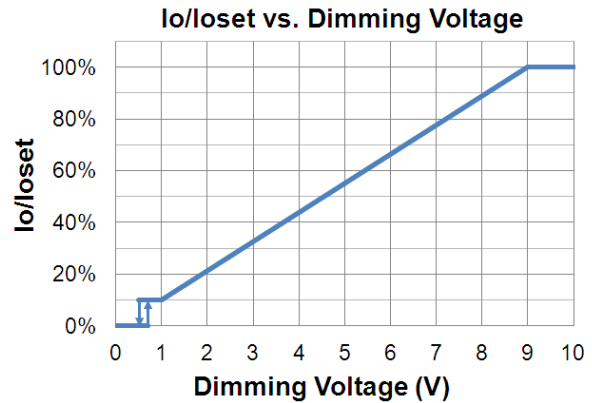
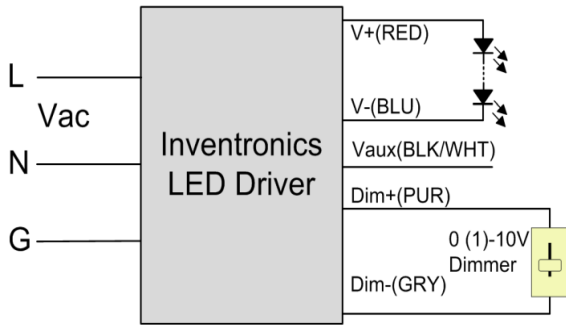

Implementation 1: DC Input

Notes:

1. The dimmer can also be replaced by an active 0-10V voltage source signal or passive components like resistors and zener.
2. Do not connect the GND of dimming to the output; otherwise, the LED driver cannot work normally.
3. If 0-10V dimming is not used, Dim + should be open.

● PWM Dimming

The recommended implementation of the dimming control is provided below.

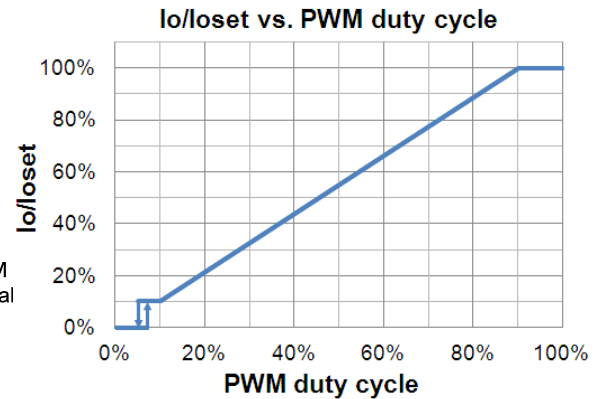
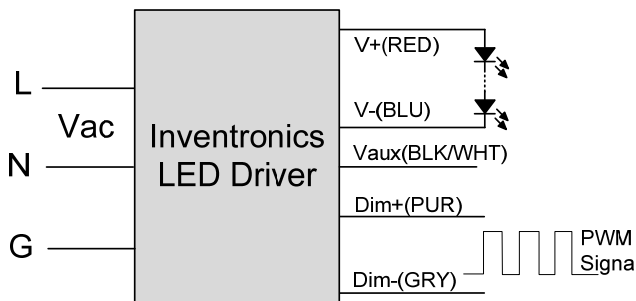

Implementation 2: Positive logic

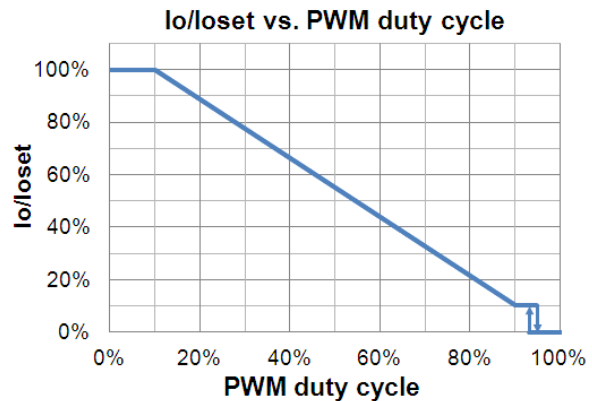
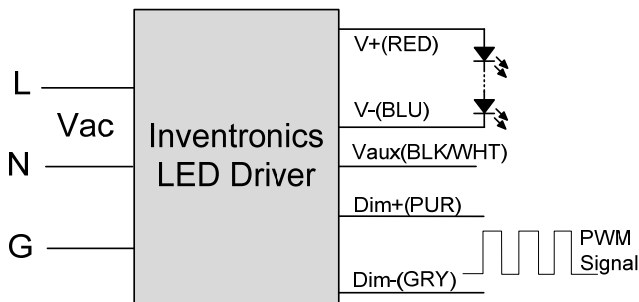

Implementation 3: Negative logic

Notes:

1. Do NOT connect Dim- to the output V- or V+, otherwise the driver will not work properly.
2. If PWM dimming is not used, Dim + should be open.
3. When PWM negative logic dimming mode and Dim+ is open, the driver will output minimum current.

● Time Dimming

Time dimming control includes 3 kinds of modes, they are Self Adapting-Midnight, Self Adapting-Percentage and Traditional Timer.

- **Self Adapting-Midnight:** Automatically adjusts the dimming curve based on the on-time of past two days (if difference <15 minutes), assuming that the center point of the dimming curve is midnight local time.
- **Self Adapting-Percentage:** Automatically adjusts the on-time of each step by a constant percentage = (actual on-time for the past 2 days if difference <15 min) / (programmed on-time from the dimming curve).
- **Traditional Timer:** Follows the programmed timing curve after power on with no changes.

● Output Lumen Compensation

Output Lumen Compensation (OLC) may be used to maintain constant light output over the life of the LEDs by driving them at a reduced current when new, then gradually increasing the drive current over time to counteract LED lumen degradation.

Programming Connection Diagram

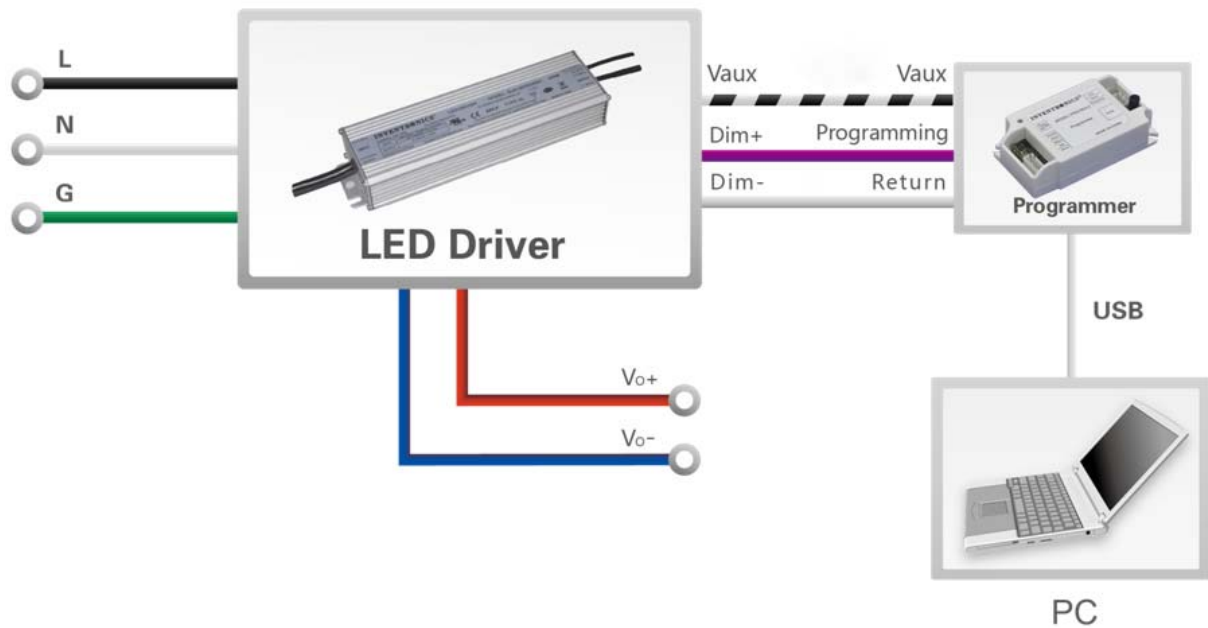

Note: The driver does not need to be powered on during the programming process.

- Please refer to [PRG-MUL2 Multi-Programmer datasheet](#) for details.

Mechanical Outline

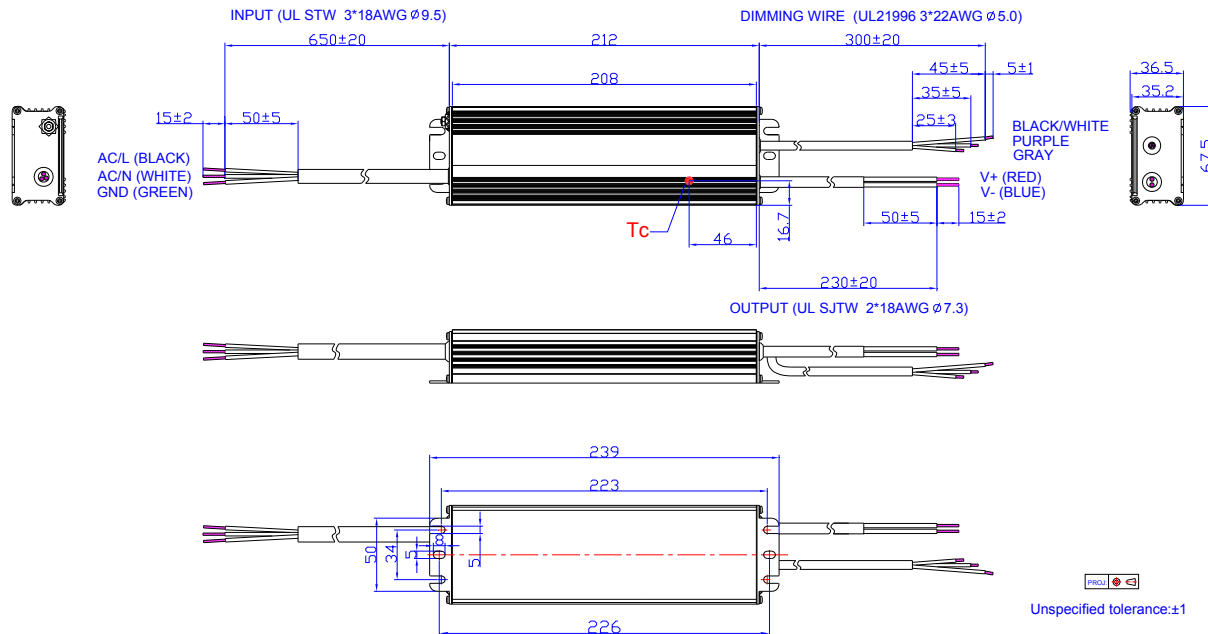

RoHS Compliance

Our products comply with reference to RoHS Directive (EU) 2015/863 amending 2011/65/EU, calling for the elimination of lead and other hazardous substances from electronic products.

Revision History

Change Date	Rev.	Description of Change		
		Item	From	To
2015-03-09	A	Datasheets Release	/	/
2016-06-30	B	Models	Adjustable Output Current Range	Updated
		I-V Operating Area	/	Updated
		Output Specifications	Output Current Setting(losset) Range	Updated
		General Specifications	With mounting ear	Updated
		General Specifications	Net Weight	Updated
		Dimming Specifications	Dimming Output Range	Updated
		Safety & EMC Compliance	/	Updated
		Programming Connection Diagram	/	Updated
2017-08-03	C	Models	/	Updated
		Input Specifications	PF/THD	Updated
		Output Specifications	Turn-on Delay Time	Updated
		Output Specifications	Temperature Coefficient of losset	Updated
		Safety & EMC Compliance	/	Updated
		Mechanical Outline	/	Updated
2019-03-28	D	CE	/	Added
		Features	/	Updated
		Description	/	Updated
		Models	/	Updated
		I-V Operating Area	/	Updated
		Input Specifications	Input Voltage	Updated
		Input Specifications	Leakage Current	Updated
		Output Specifications	Output Current Setting(losset) Range	Updated
		Output Specifications	Output Current Setting Range with Constant Power	Updated
		Output Specifications	Turn-on Delay Time	Updated
General Specifications	Lifetime	Updated		

Revision History (Continued)

Change Date	Rev.	Description of Change		
		Item	From	To
2019-03-28	D	General Specifications	Operating Case Temperature for Warranty Tc_w	Updated
		Dimming Specifications	Dimming Output Range	Updated
		Safety & EMC Compliance	/	Updated
		Lifetime vs. Case Temperature	/	Updated
		Dimming	/	Updated
		Mechanical Outline	/	Updated
2020-11-05	E	Format	/	Updated
		Models	Notes: (4)	Updated
		RoHS Compliance	/	Updated