

■ PRODUCT CHARACTERISTICS

VDSS	650V
R _{DS(on)} Typ(@V _{GS} =10 V)	2.41Ω
Qg@type	25nC
ID	4A

■ APPLICATIONS

- * High frequency switching mode power supply
- * Electronic ballast
- * LED power supplies

■ FEATURES

- * Fast switching capability
- * Avalanche energy tested
- * Improved dv/dt capability, high ruggedness

■ ORDER INFORMATION

Order codes		Package	Packing
Halogen-Free	Halogen		
N/A	MOT4N65D	TO-252	2500 pieces /Reel
N/A	MOT4N65C	TO-251	70 pieces/Tube

Symbol

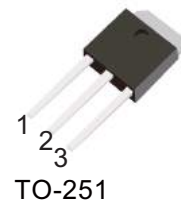
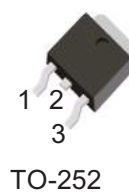
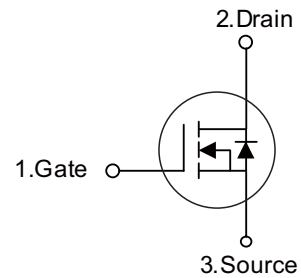

■ ABSOLUTE MAXIMUM RATINGS (T_C = 25°C, unless otherwise specified)

PARAMETER	SYMBOL	RATINGS	UNIT
Drain-Source Voltage	V _{DSS}	650	V
Gate-Source Voltage	V _{GSS}	±30	V
Avalanche Current (Note 2)	I _{AR}	4.0	A
Drain Current	Continuous	I _D	4.0
	Pulsed (Note 2)	I _{DM}	16
Avalanche Energy	Single Pulsed (Note 3)	E _{AS}	260
	Repetitive (Note 2)	E _{AR}	10.6
Peak Diode Recovery dv/dt (Note 4)	dv/dt	4.5	V/ns
Power Dissipation	P _D	50	W
Junction Temperature	T _J	+150	°C
Operating Temperature	T _{OPR}	-55 ~ +150	°C
Storage Temperature	T _{STG}	-55 ~ +150	°C

Note: 1. Absolute maximum ratings are those values beyond which the device could be permanently damaged.

Absolute maximum ratings are stress ratings only and functional device operation is not implied.

2. Repetitive Rating : Pulse width limited by maximum junction temperature
3. L = 30mH, I_{AS} = 4A, V_{DD} = 50V, R_G = 25 Ω, Starting T_J = 25°C
4. I_{SD} ≤ 4.4A, di/dt ≤ 200A/μs, V_{DD} ≤ BV_{DSS}, Starting T_J = 25°C

■ ELECTRICAL CHARACTERISTICS ($T_C=25^\circ\text{C}$, unless otherwise noted)

PARAMETER	SYMBOL	TEST CONDITIONS	MIN	TYP	MAX	UNIT
Off characteristics						
Drain-Source Breakdown Voltage	BV_{DSS}	$V_{GS} = 0V, I_D = 250\mu A$	650	-	-	V
Drain-Source Leakage Current	I_{DSS}	$V_{DS} = 650V, V_{GS} = 0V$	-	-	1	μA
Gate- Source Leakage Current	Forward	I_{GSS}	-	-	100	nA
	Reverse				-100	nA
On characteristics						
Gate Threshold Voltage	$V_{GS(TH)}$	$V_{DS} = V_{GS}, I_D = 250\mu A$	2.0	-	4.0	V
Static Drain-Source On-State Resistance	$R_{DS(ON)}$	$V_{GS} = 10V, I_D = 2.0A$	-	2.41	2.8	Ω
Dynamic characteristics						
Input Capacitance	C_{ISS}	$V_{DS}=25V, V_{GS}=0V, f=1.0\text{ MHz}$	-	520	-	pF
Output Capacitance	C_{OSS}		-	75	-	pF
Reverse Transfer Capacitance	C_{RSS}		-	13	-	pF
Switching characteristics						
Total Gate Charge (Note 1)	Q_G	$V_{DS}=300V, V_{GS}=10V, I_D=3.0A$ (Note 1, 2)	-	19	-	nC
Gate-Source Charge	Q_{GS}		-	3.5	-	nC
Gate-Drain Charge	Q_{GD}		-	5.8	-	nC
Turn-On Delay Time (Note 1)	$t_{D(ON)}$	$V_{DD}=50V, V_{GS}=10V, I_D=0.5A,$ $R_G=25\Omega$ (Note 1, 2)	-	9.0	-	ns
Turn-On Rise Time	t_R		-	22	-	ns
Turn-Off Delay Time	$t_{D(OFF)}$		-	53	-	ns
Turn-Off Fall Time	t_F		-	42	-	ns
Drain-source diode diode characteristics						
Maximum Continuous Drain-Source Diode Forward Current	I_S		-	-	4	A
Maximum Pulsed Drain-Source Diode Forward Current	I_{SM}		-	-	16	A
Drain-Source Diode Forward Voltage	V_{SD}	$I_S=4.0A, V_{GS}=0V$	-	-	1.4	V
Body Diode Reverse Recovery Time	t_{rr}	$I_S=4.0A, V_{GS}=0V, di/dt=100A/\mu s$	-	290	-	ns
Body Diode Reverse Recovery Charge	Q_{rr}		-	1.65	-	μC

 Notes: 1. Pulse Test: Pulse width $\leq 300\mu s$, Duty cycle $\leq 2\%$.

2. Essentially independent of operating temperature.

■ TYPICAL CHARACTERISTICS

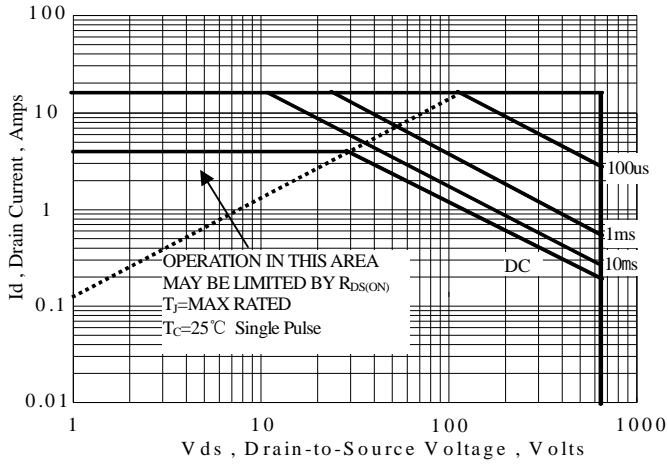

Figure 1 Maximum Forward Bias Safe Operating Area

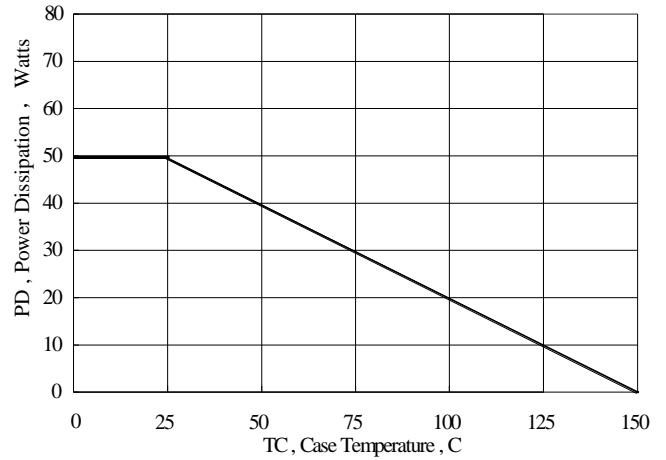

Figure 2 Maximum Power Dissipation vs Case Temperature

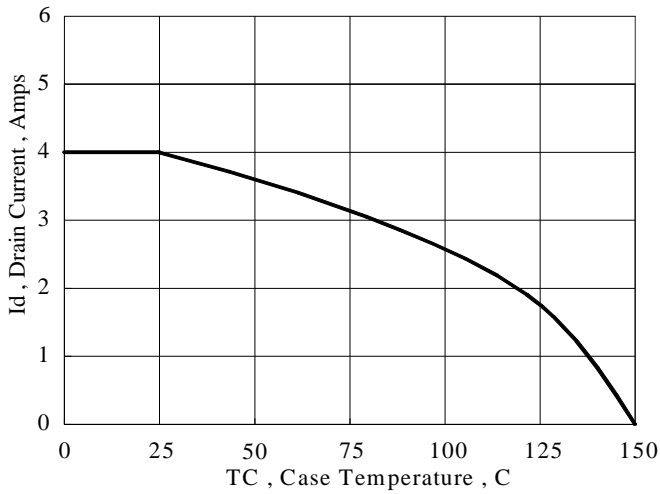

Figure 3 Maximum Continuous Drain Current vs Case Temperature

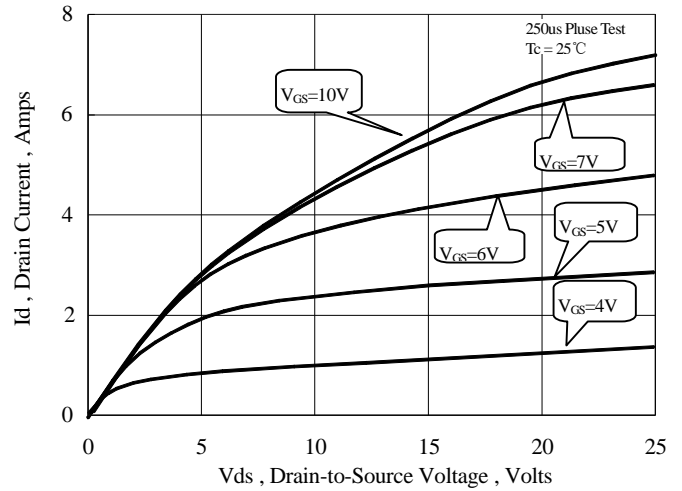

Figure 4 Typical Output Characteristics

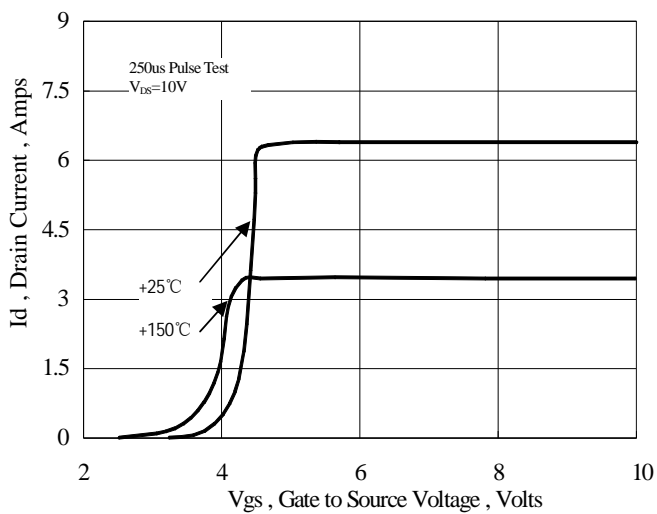

Figure 6 Typical Transfer Characteristics

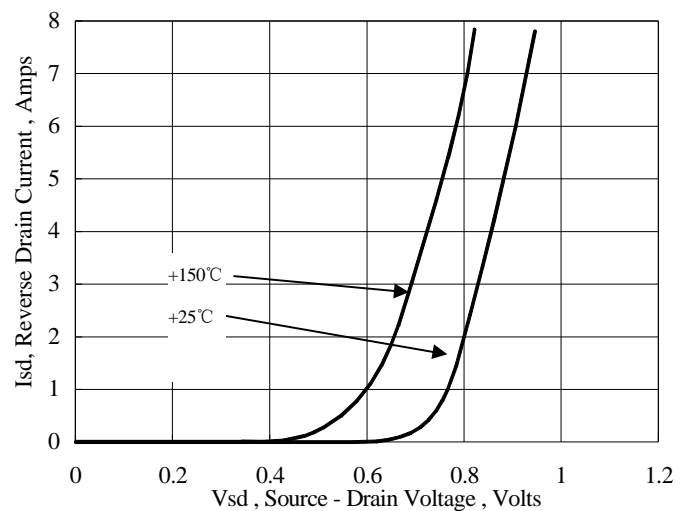

Figure 7 Typical Body Diode Transfer Characteristics

■ TYPICAL CHARACTERISTICS(Cont.)

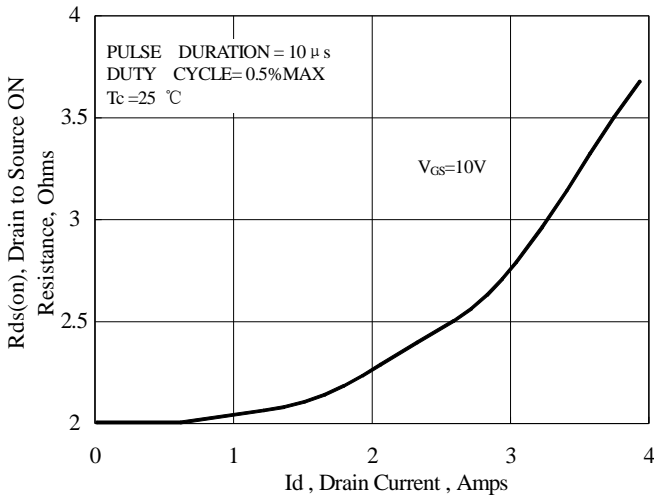

Figure 8 Typical Drain to Source ON Resistance vs Drain Current

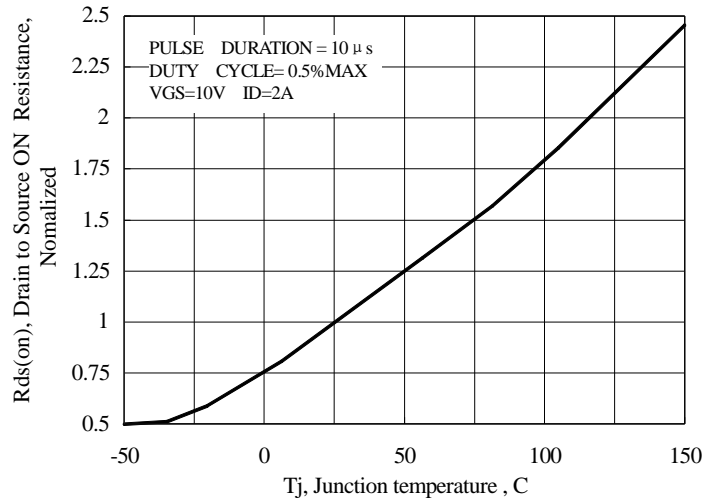

Figure 9 Typical Drain to Source on Resistance vs Junction Temperature

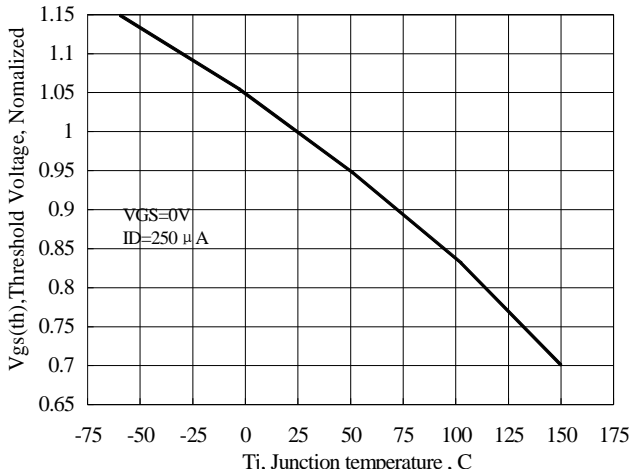

Figure 10 Typical Threshold Voltage vs Junction Temperature

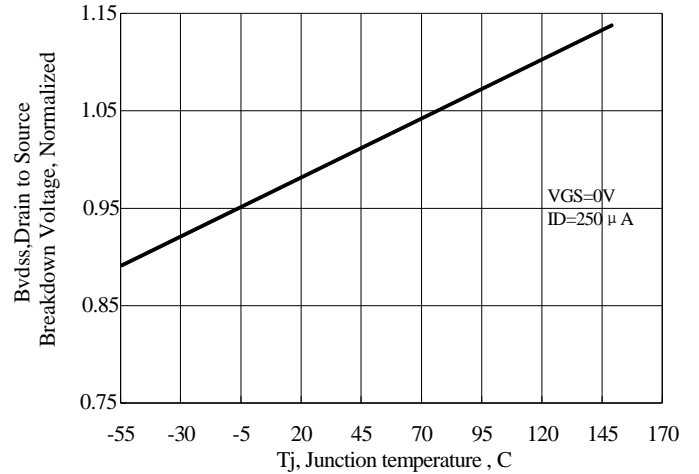

Figure 11 Typical Breakdown Voltage vs Junction Temperature

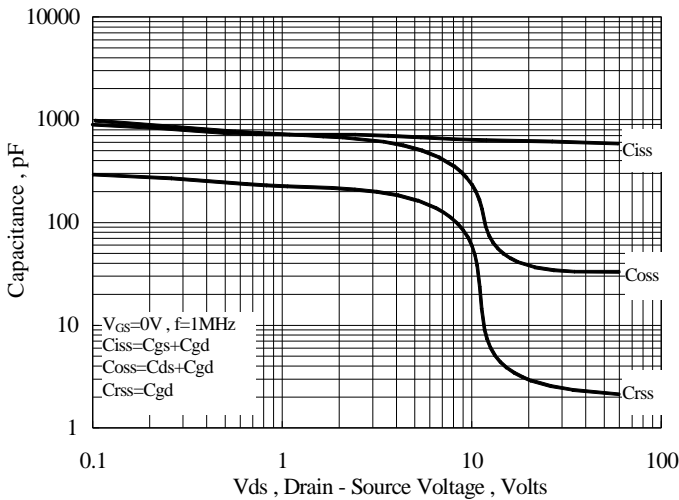

Figure 12 Typical Capacitance vs Drain to Source Voltage

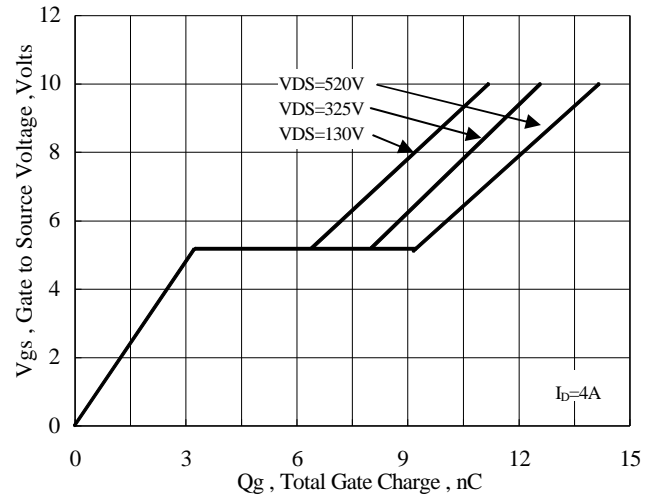
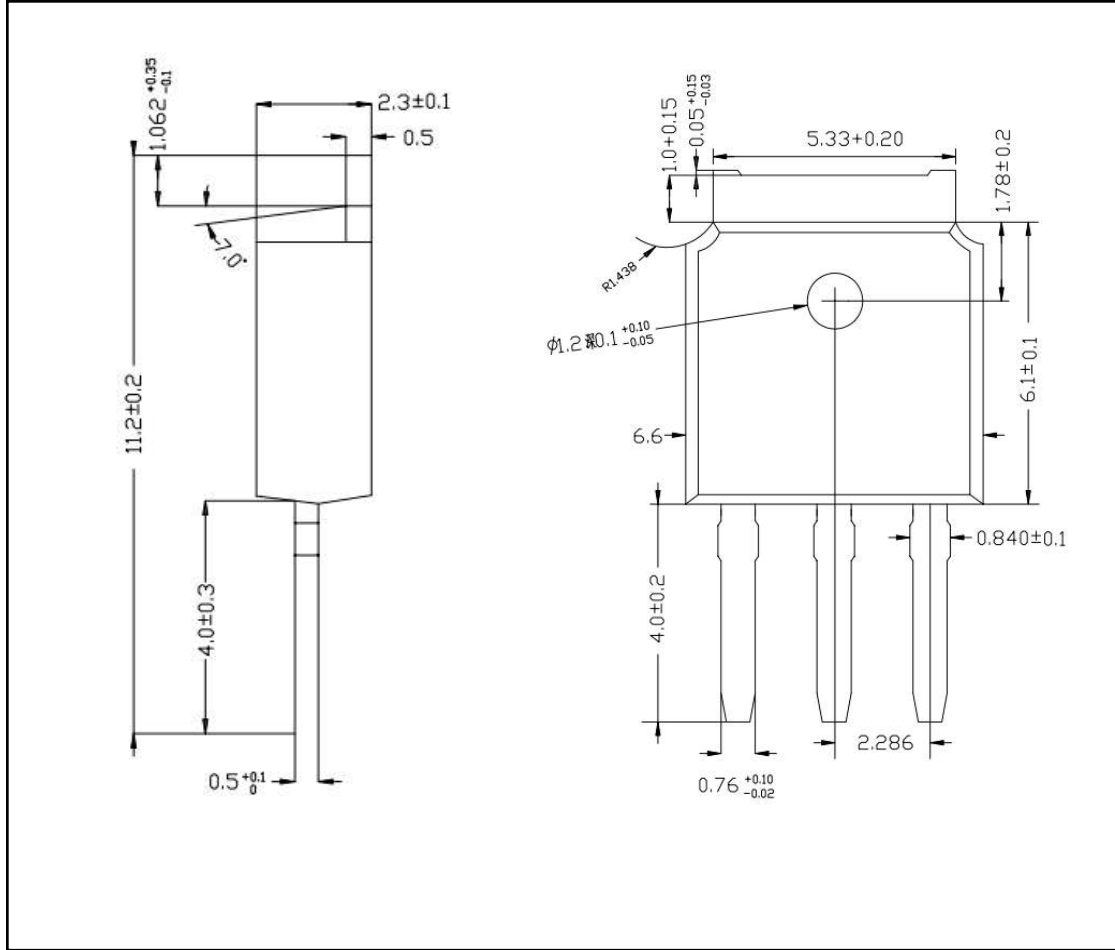

Figure 13 Typical Gate Charge vs Gate to Source Voltage

■ TO-251-3L PACKAGE OUTLINE DIMENSIONS



■ TO-252-2L PACKAGE OUTLINE DIMENSIONS

