

Ordering number C12726_STRADA-SQ-T-DWC

Family	Strada-SQ	FWHM	Asym degrees
Type	Lens	Efficiency	94 %
LED	LUXEON M	cd/Im	0.450
Color	Clear	Gerber File	Available
Diameter	25 x 25 mm		
Height	8 mm		
Style	Square		
Optic Material	PMMA		
Holder Material	-		
Fastening	Screw, pin, glue		
Status	On production		

Ordering number CA12889_STRADA-SQ-T-DWC

Family	Strada-SQ	FWHM	Asym degrees
Type	Assembly	Efficiency	94 %
LED	LUXEON M	cd/Im	0.450
Color	Clear	Gerber File	Available
Diameter	25 x 25 mm		
Height	8.15 mm		
Style	Square		
Optic Material	PMMA		
Holder Material	-		
Fastening	Screw, pin, tape		
Status	On production		

Ordering number C13118_STRADA-SQ-A-T

Family	Strada-SQ	FWHM	Asym degrees
Type	Lens	Efficiency	93 %
LED	LUXEON M	cd/lm	0.300
Color	Clear	Gerber File	Available
Diameter	25 + 25 mm		
Height	9 mm		
Style	Square		
Optic Material	PMMA		
Holder Material	-		
Fastening	Screw, pin, glue		
Status	On production		

Ordering number CA13119_STRADA-SQ-A-T

Family	Strada-SQ	FWHM	Asym degrees
Type	Assembly	Efficiency	93 %
LED	LUXEON M	cd/lm	0.300
Color	Clear	Gerber File	Available
Diameter	25 + 25 mm		
Height	9.1 mm		
Style	Square		
Optic Material	PMMA		
Holder Material	-		
Fastening	Screw, pin, tape		
Status	On production		

Ordering number CA13509_STRADA-SQ-T2

Family	Strada-SQ	FWHM	Asym degrees
Type	Assembly	Efficiency	93 %
LED	LUXEON M	cd/lm	0.600
Color	Black	Gerber File	Available
Diameter	25 x 25 mm		
Height	8.7 mm		
Style	Square		
Optic Material	PMMA		
Holder Material	-		
Fastening	Screw, pin, tape		
Status	On production		

We recommend a minimum center to center spacing between S

Ordering number CA13688_STRADA-SQ-T3

Family	Strada-SQ	FWHM	Asym degrees
Type	Assembly	Efficiency	92 %
LED	LUXEON M	cd/lm	0.500
Color	Clear	Gerber File	Available
Diameter	25 x 25 mm		
Height	8.4 mm		
Style	Square		
Optic Material	PMMA		
Holder Material	-		
Fastening	Pin, tape		
Status	On production		

We recommend a minimum center to center spacing between S

Ordering number C13866_STRADA-SQ-CY

Family	Strada-SQ	FWHM	120+115 degrees
Type	Lens	Efficiency	94 %
LED	LUXEON M	cd/lm	0.410
Color	Clear	Gerber File	Available
Diameter	25x25 mm		
Height	10.1 mm		
Style	Square		
Optic Material	PMMA		
Holder Material	-		
Fastening	Pin		
Status	On production		

Ordering number C12727_STRADA-SQ-VSM

Family	Strada-SQ	FWHM	154 degrees
Type	Lens	Efficiency	93 %
LED	LUXEON M	cd/lm	0.250
Color	Clear	Gerber File	Available
Diameter	25 x 25 mm		
Height	6.8 mm		
Style	Square		
Optic Material	PMMA		
Holder Material	-		
Fastening	Screw, pin, glue		
Status	On production		

Ordering number CA12891_STRADA-SQ-VSM

Family	Strada-SQ	FWHM	154 degrees
Type	Assembly	Efficiency	93 %
LED	LUXEON M	cd/lm	0.250
Color	Clear	Gerber File	Available
Diameter	25 x 25 mm		
Height	6.95 mm		
Style	Square		
Optic Material	PMMA		
Holder Material	-		
Fastening	Screw, pin, tape		
Status	On production		

Ordering number C12410
Description 1

Family	Strada-SQ	FWHM	Asym degrees
Type	Lens	Efficiency	93 %
LED	LUXEON M	cd/lm	(simulated) 0.000
Color	Clear	Gerber File	Available
Diameter	25 + 25 mm		
Height	9 mm		
Style	Square		
Optic Material	PMMA		
Holder Material	-		
Fastening	-		
Status	On production		

Positioning: External position element / Automatic assembling li



PRODUCT DATASHEET

Strada-SQ series

last update 3/10/2013

PHILIPS
LUMILEDS

Ordering number	CA12411
Description	1
Family	Strada-SQ
Type	Assembly
LED	LUXEON M
Color	Clear
Diameter	25 + 25 mm
Height	9.15 mm
Style	Square
Optic Material	PMMA
Holder Material	-
Fastening	-
Status	On production

FWHM	Asym degrees
Efficiency	93 %
cd/lm	0.410
Gerber File	Available

Positioning: External position element / Automatic assembling li

NOTE: The typical divergence will be changed by different color, chip size and chip position tolerance. The typical total divergence is the full angle measured where the luminous intensity is half of the peak value.



PRODUCT DATASHEET Strada-SQ series

last update 3/10/2013

PHILIPS
LUMILEDS

GENERAL INFORMATION

- Product series especially designed & optimized for LUXEON M series of LEDs.
- Special care taken to make light distribution as uniform as possible.
- Lens material optical grade PMMA with high UV and temperature resistance. Allows use of high current and temperature conditions.

Please find more information about used material from below:

http://ledil.fi/sites/default/files/Documents/Technical/Material/PMMA%20N%20UL94_Yellow%20Card.pdf

<http://ledil.fi/sites/default/files/Documents/Technical/Material/PMMA%20N%20PLEXIGLAS-Datasheet.pdf>

Absolute intensity of C12726&CA12889_STRADA-SQ-T-DWC (Luxeon M)

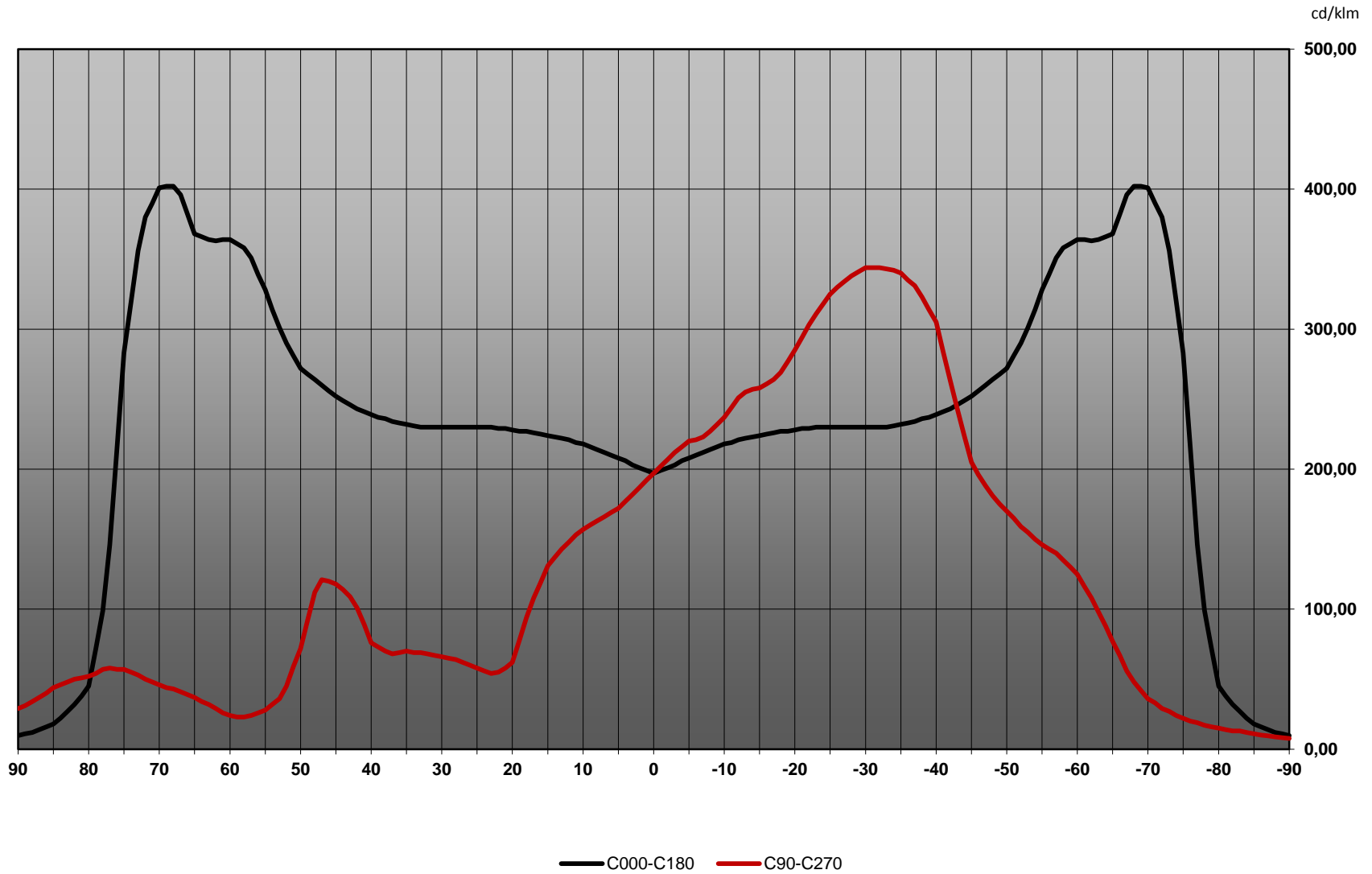

Absolute intensity of C12726&CA12889_STRADA-SQ-T-DWC (Luxeon M)

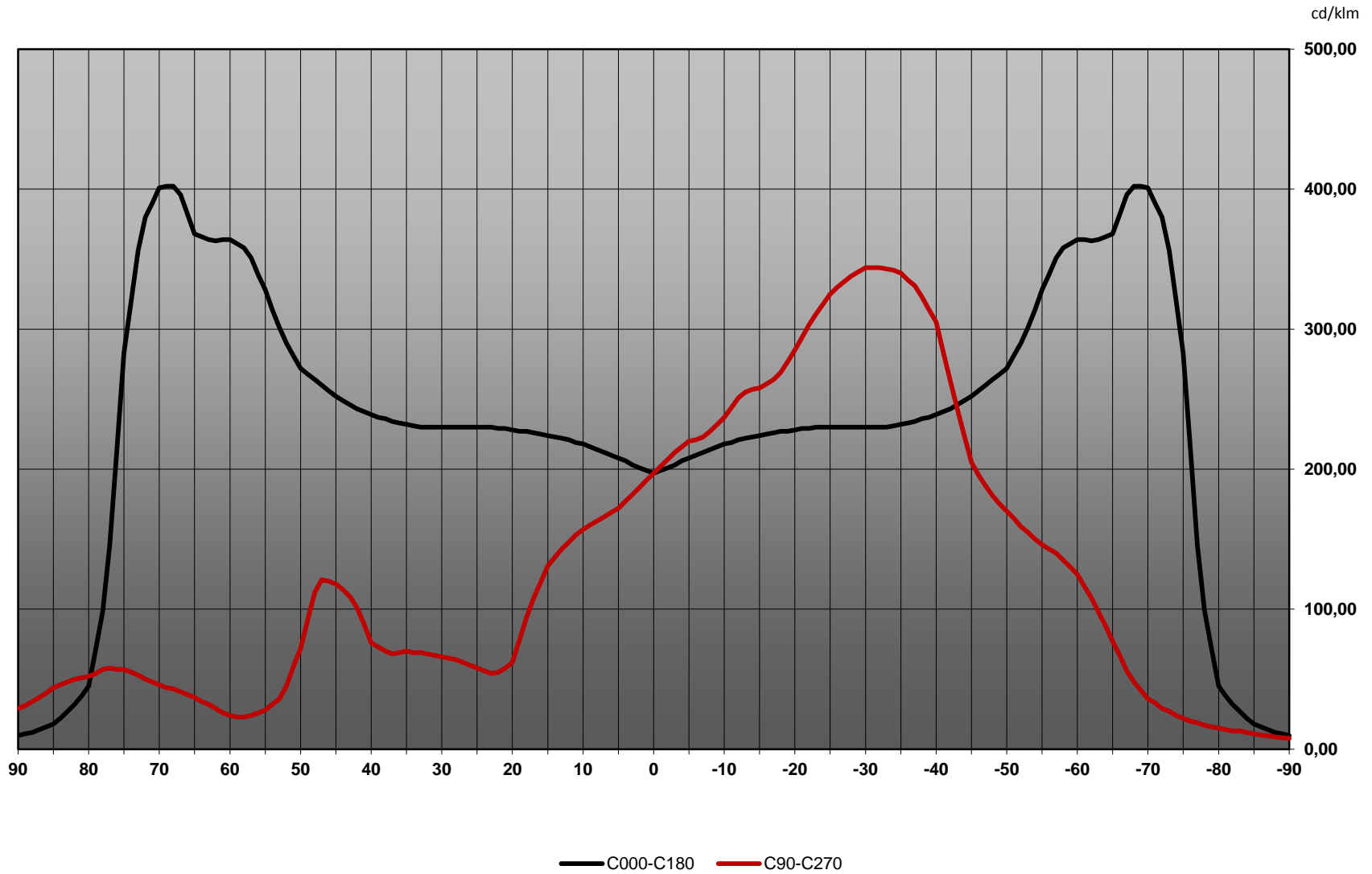

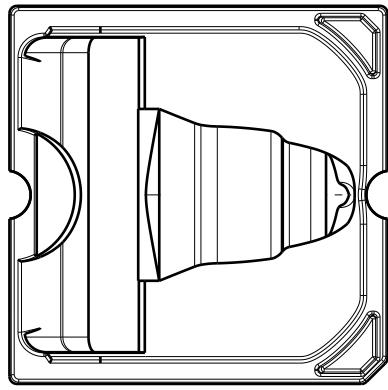

Bottom view

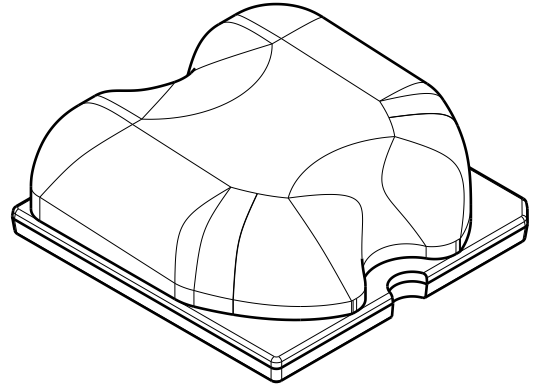

Isometric view

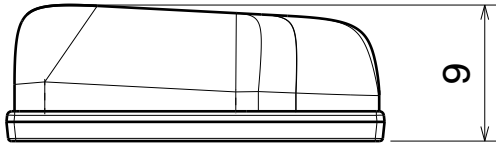

Front view

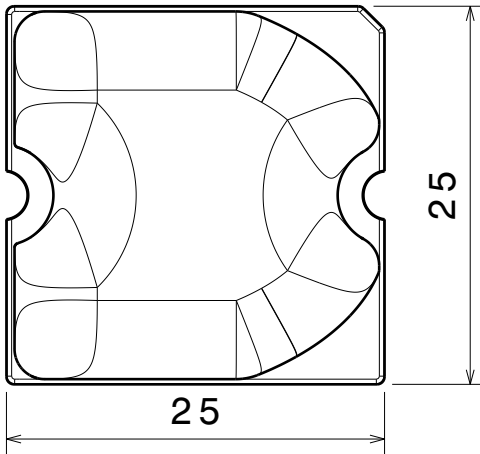

Top view

Tolerances if not otherwise shown:
According to DIN ISO 2768-1
Linear measures:
Up to 30mm class F, otherwise class M.

According to DIN ISO 2768-2
Form and position:
class K

Control for SPC marked dimensions.

This drawing is our property.
It can't be reproduced
or communicated without
our written agreement.



Ledil Oy
Salorankatu 10
FIN 24240 SALO
Finland

DRAWING TITLE Mechanical drawing

DRAWN BY
as
DATE
25.9.2012

STRADA-SQ-A-T

CHECKED BY
VS
DATE
-

SIZE A4
PART NUMBER
REV 001

DESIGNED BY
-
DATE
-

SCALE 2:1
WEIGHT 4,97 g
SHEET 1/1

Luminaire: LEDiL C12726&CA12889_STRADA-SQ-T-DWC (Luxeon M) Efficiency=94%
Lamps: 1 x Luxeon M (360lm@250mA)

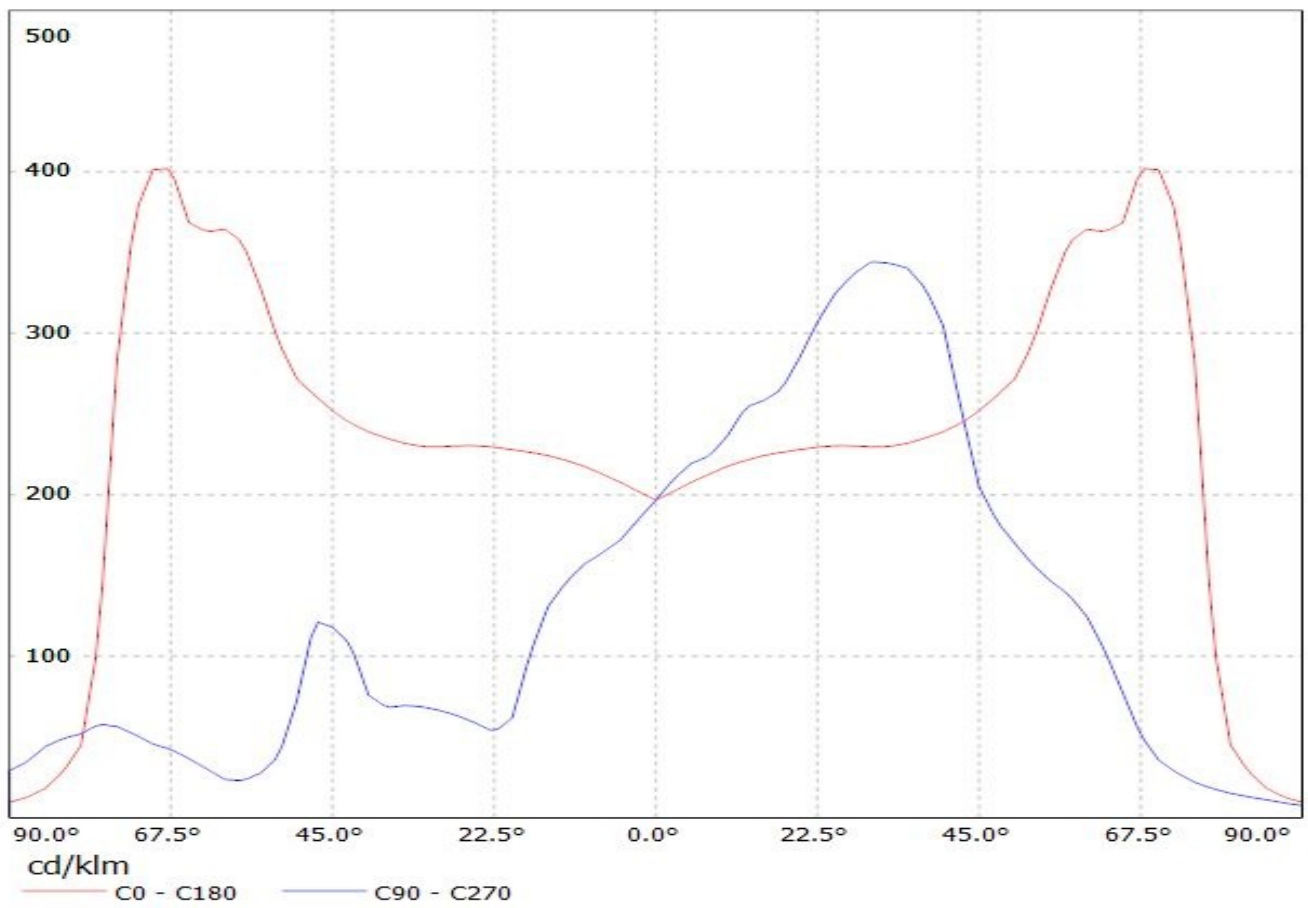

Luminaire: LEDiL C12726&CA12889_STRADA-SQ-T-DWC (Luxeon M) Efficiency=94%
Lamps: 1 x Luxeon M (360lm@250mA)

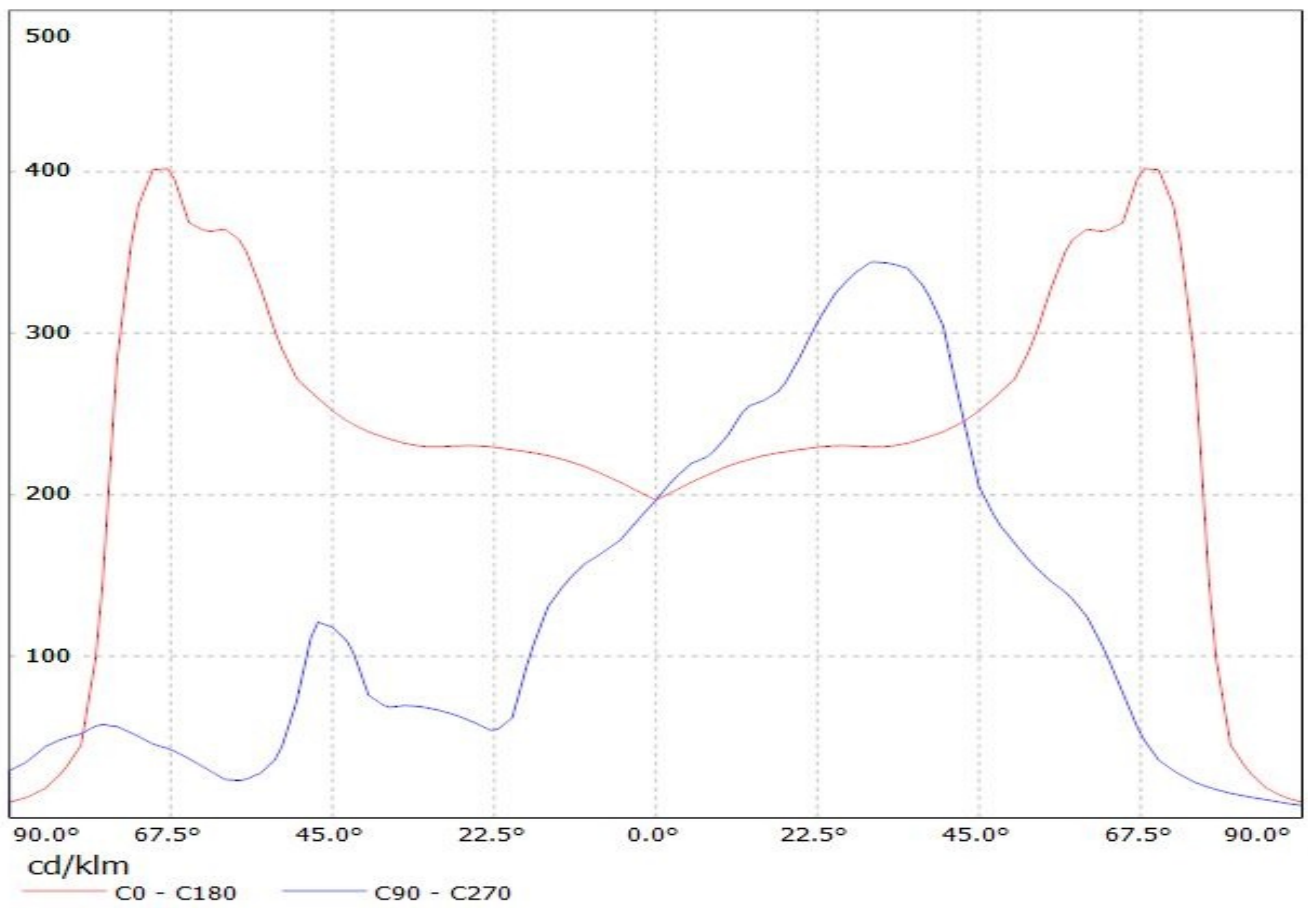

Luminaire: LEDiL Oy C13118_ & CA13119_STRADA-SQ-A-T-LuxM (Luxeon M 362lm @ 250mA) Efficiency=93%
Lamps: 1 x Luxeon M 362lm @ 250mA

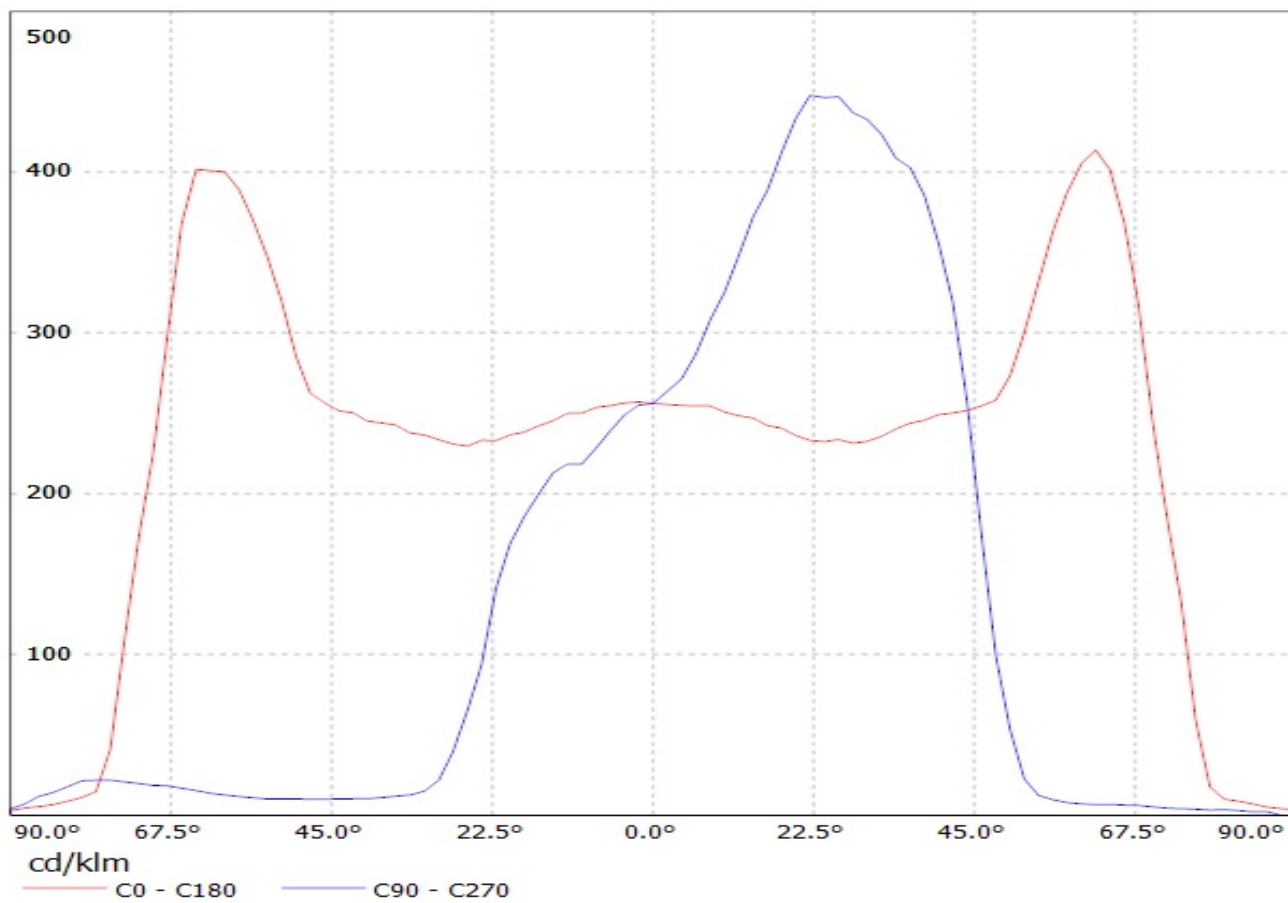

Luminaire: LEDiL Oy C13118_ & CA13119_STRADA-SQ-A-T-LuxM (Luxeon M 362lm @ 250mA) Efficiency=93%
Lamps: 1 x Luxeon M 362lm @ 250mA

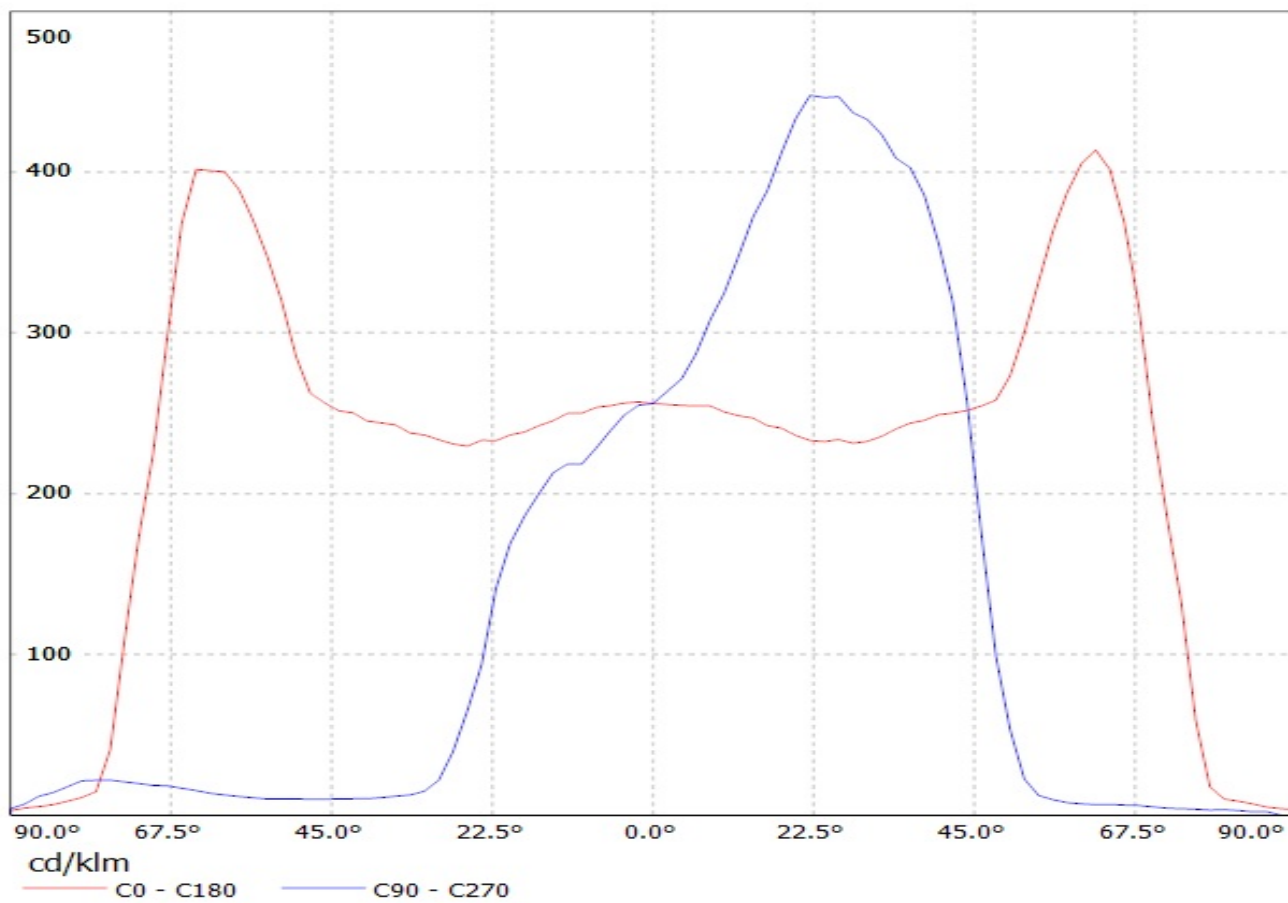

LEDiL Oy CA13509_STRADA-SQ-T2_(LUXEON_M) Eff.93.1% / LDC (Linear)

Luminaire: LEDiL Oy CA13509_STRADA-SQ-T2_(LUXEON_M) Eff.93.1%
Lamps: 1 x LUXEON_M_350.373lm@250mA_CCT=4092K_P=2.73116W_I=249.9mA

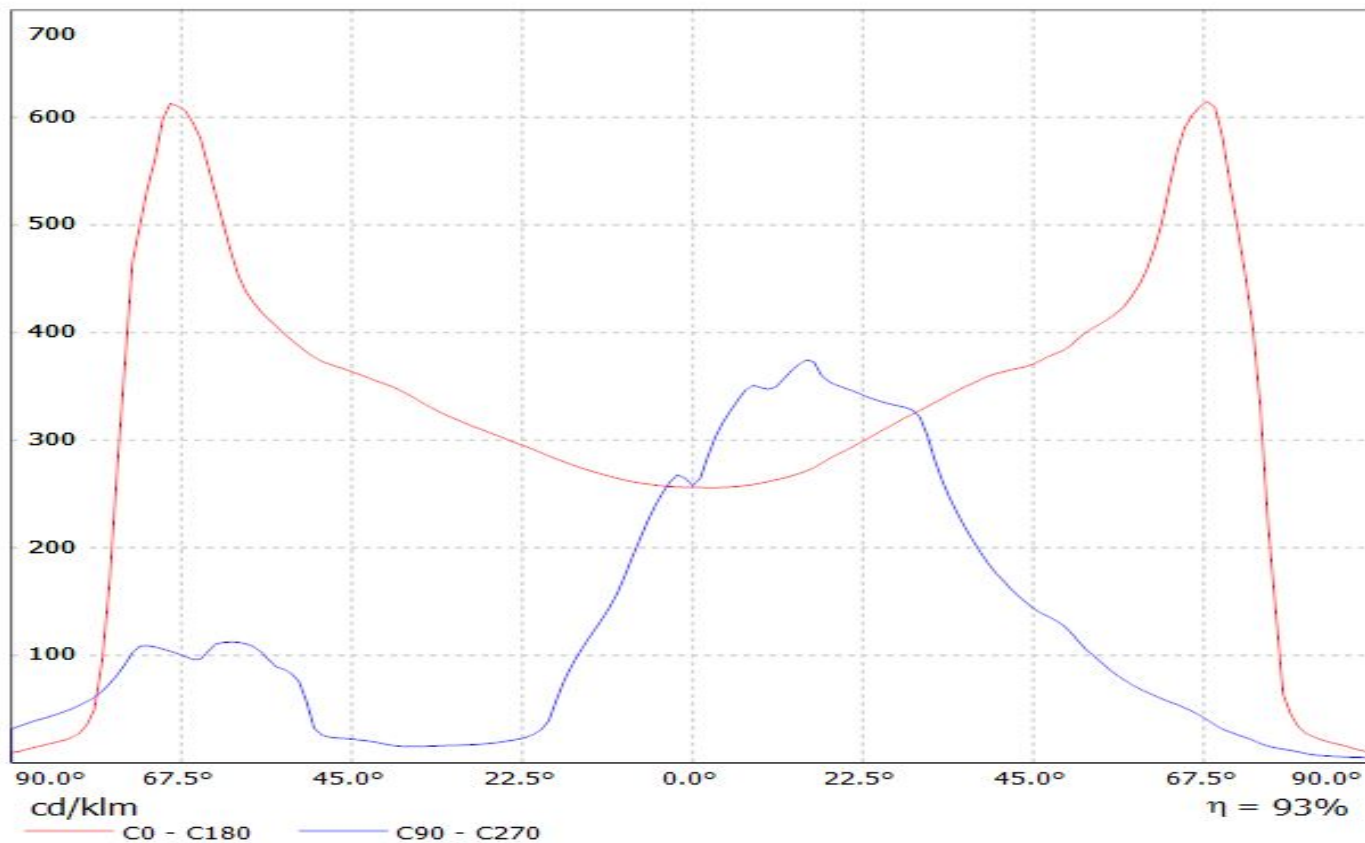

LEDiL Oy CA13688_STRADA-SQ-T3_(LUXEON_M) Eff.91.7% / LDC (Linear)

Luminaire: LEDiL Oy CA13688_STRADA-SQ-T3_(LUXEON_M) Eff.91.7%
Lamps: 1 x LUXEON_M_350.373lm@250mA_CCT=4092K_P=2.73116W_I=249.9mA

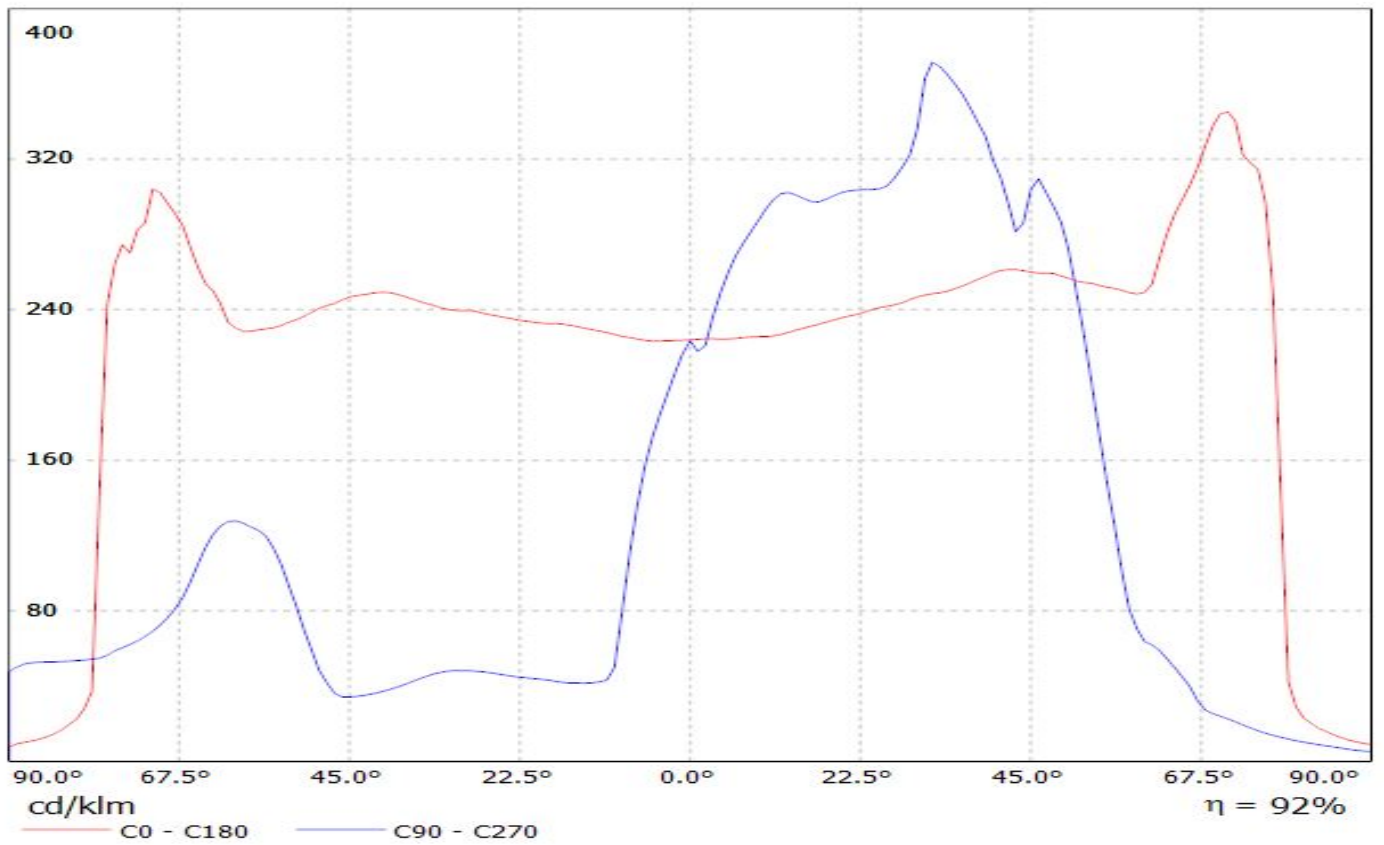

LEDiL Oy C13866_STRADA-SQ-CY_(LUXEON_M) Eff.94.0% / LDC (Linear)

Luminaire: LEDiL Oy C13866_STRADA-SQ-CY_(LUXEON_M) Eff.94.0%
Lamps: 1 x LUXEON_M_359.1lm@250mA_CCT=4092K_P=2.73016W_I=249.9mA

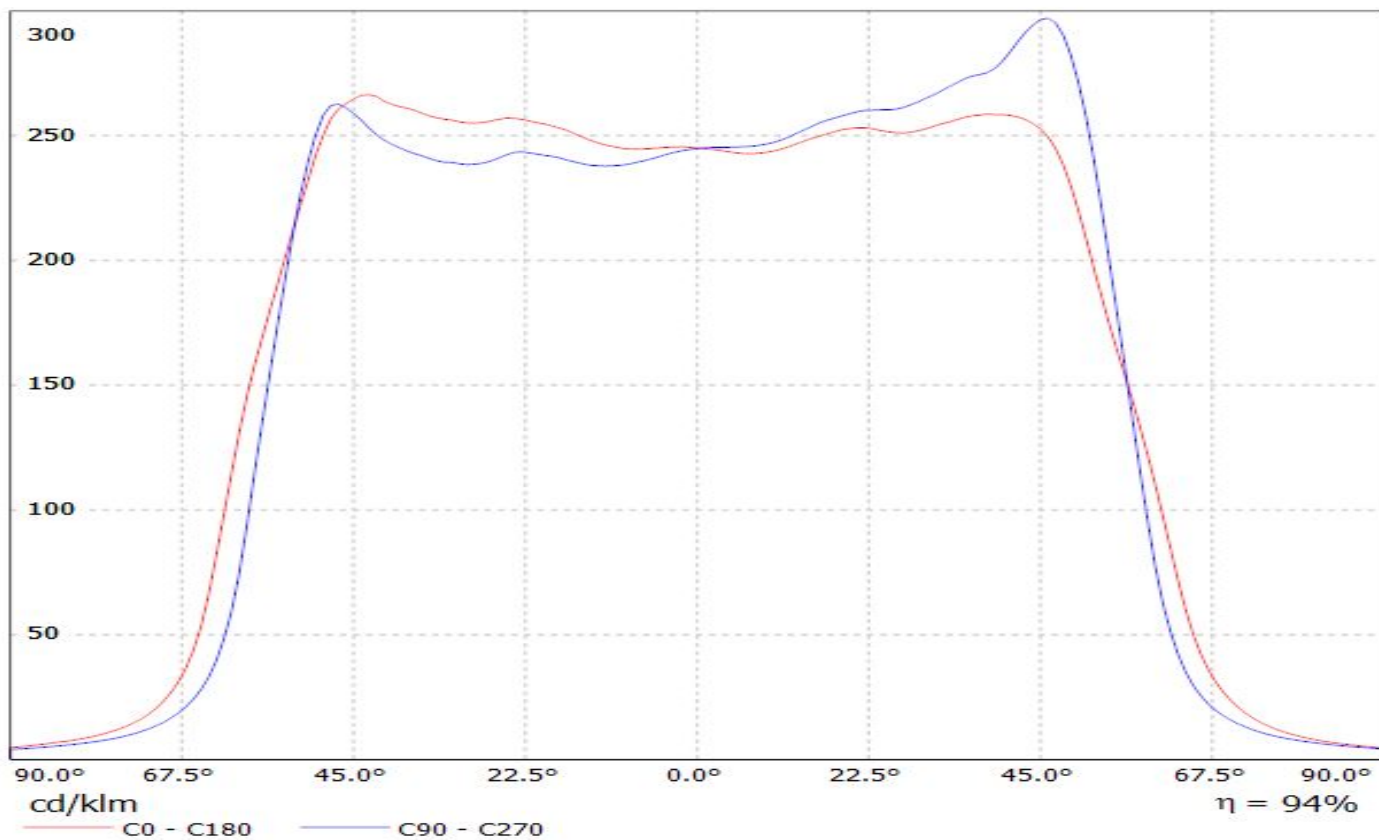

Luminaire: LEDIL OY C12727_STRADA-SQ-VSM (Luxeon M) Efficiency=95%
Lamps: 1 x Luxeon M (360lm@250mA)

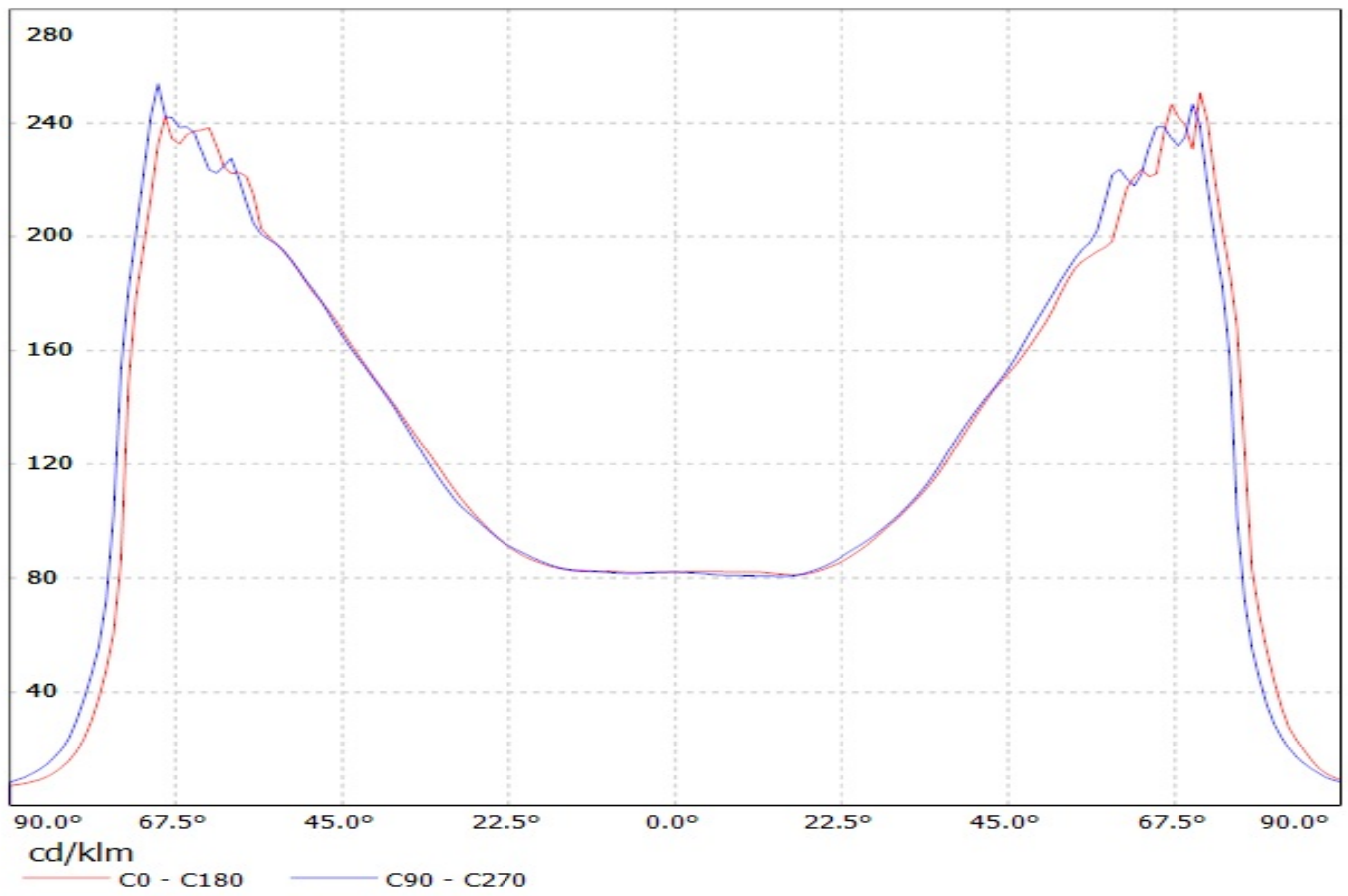

Luminaire: LEDIL OY C12727_STRADA-SQ-VSM (Luxeon M) Efficiency=95%
Lamps: 1 x Luxeon M (360lm@250mA)

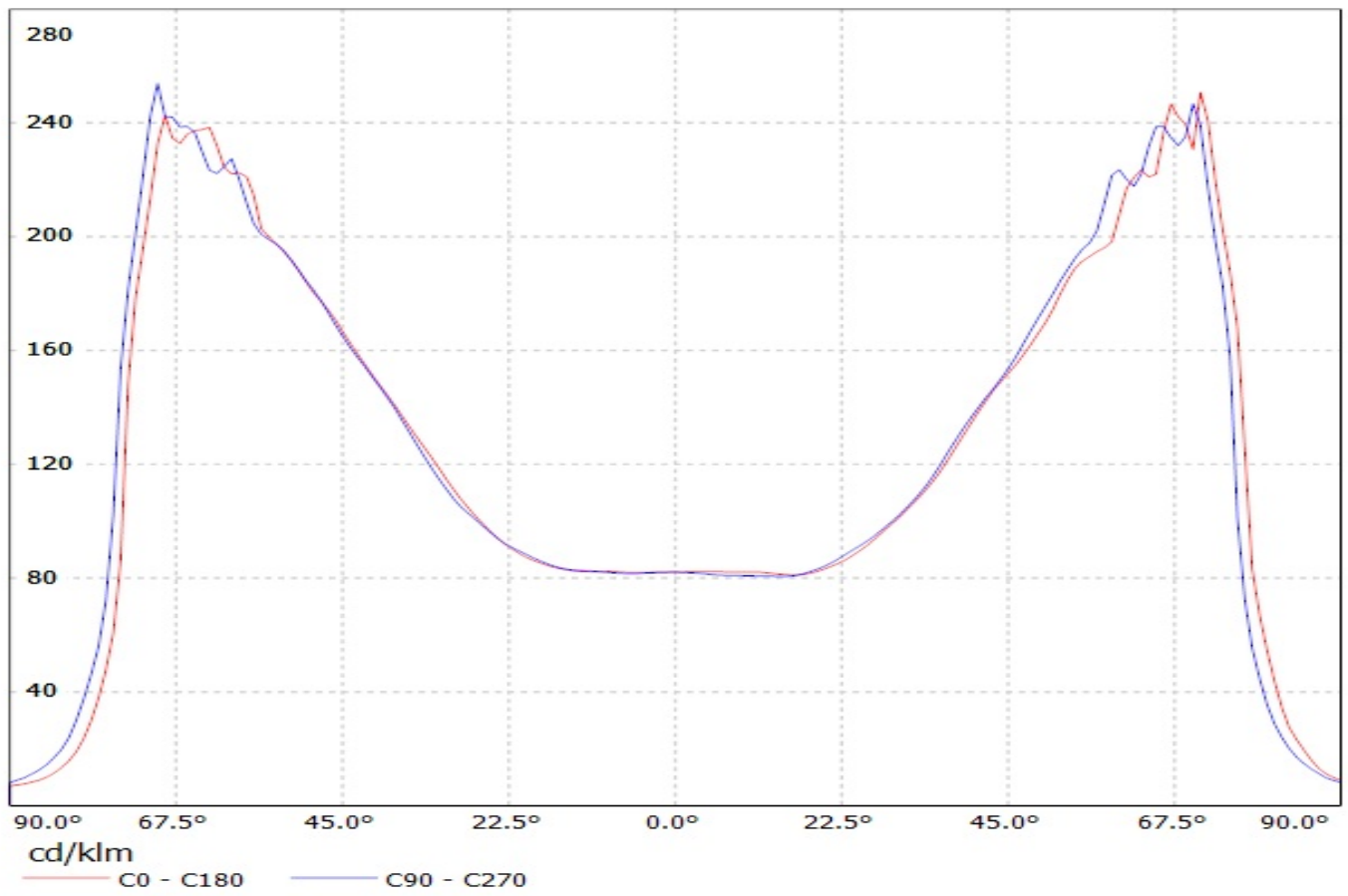

Luminaire: Ledil Oy C12410_STRADA-SQ-A-T (Luxeon M) Efficiency=93%
Lamps: 1 x Luxeon M 362lm @ 250mA

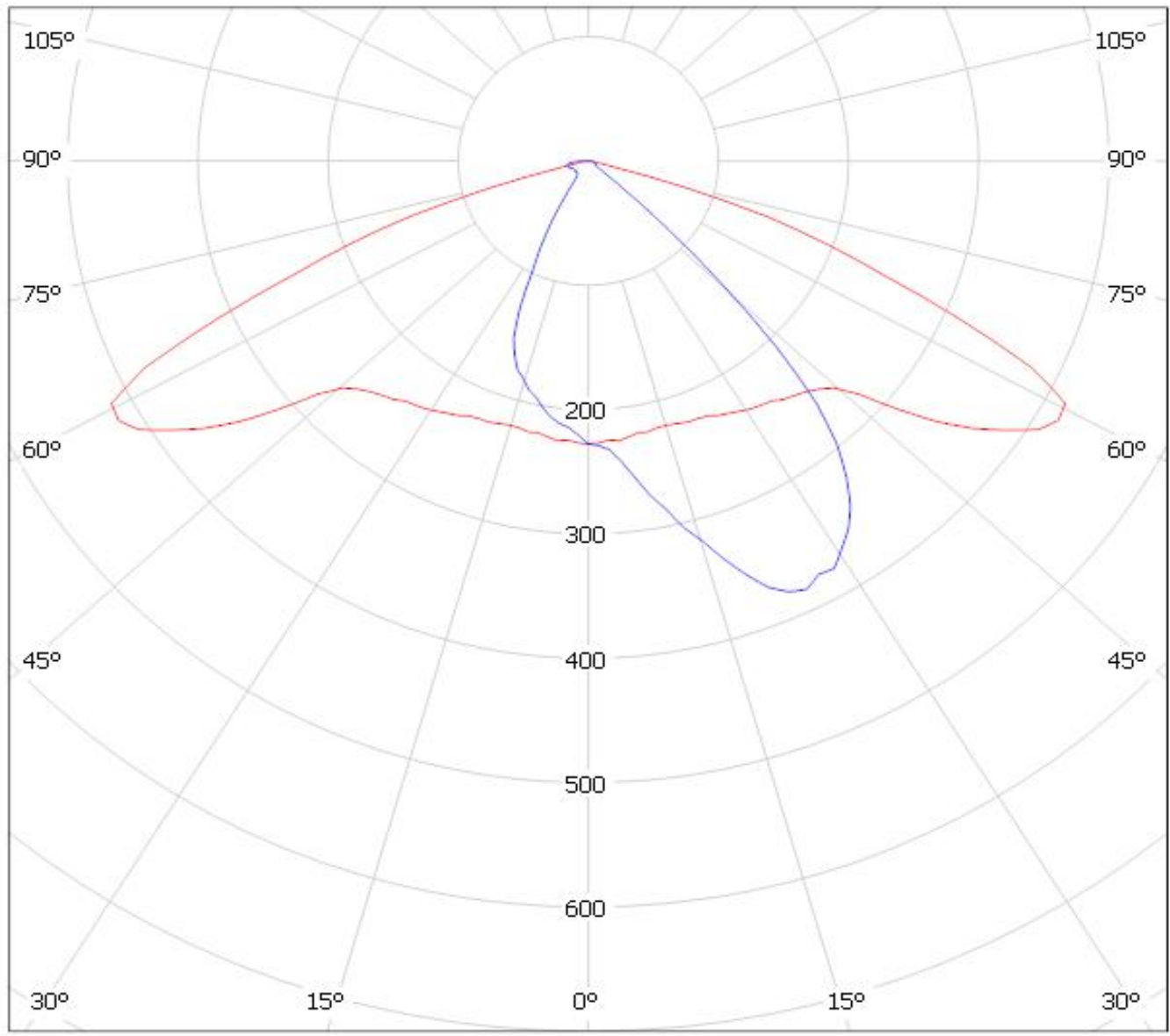

cd/klm
— C0 - C180 — C90 - C270

$\eta = 91\%$

Luminaire: Ledil Oy C12411_STRADA-SQ-A-T (Luxeon M) Efficiency=93%
Lamps: 1 x Luxeon M 362lm @ 250mA

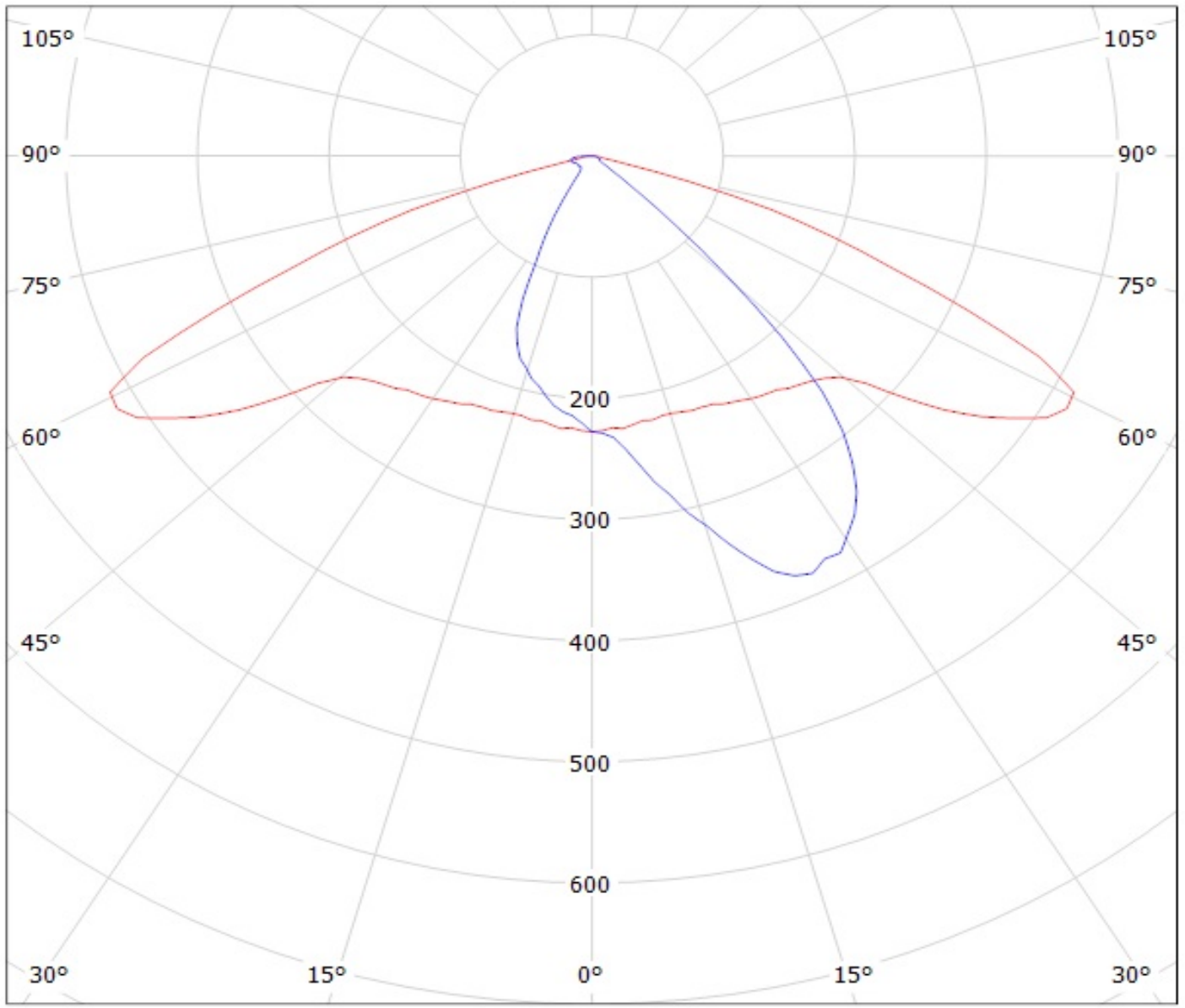

cd/klm

— C0 - C180 — C90 - C270

Luminaire: LEDiL C12726&CA12889_STRADA-SQ-T-DWC (Luxeon M) Efficiency=94%
Lamps: 1 x Luxeon M (360lm@250mA)

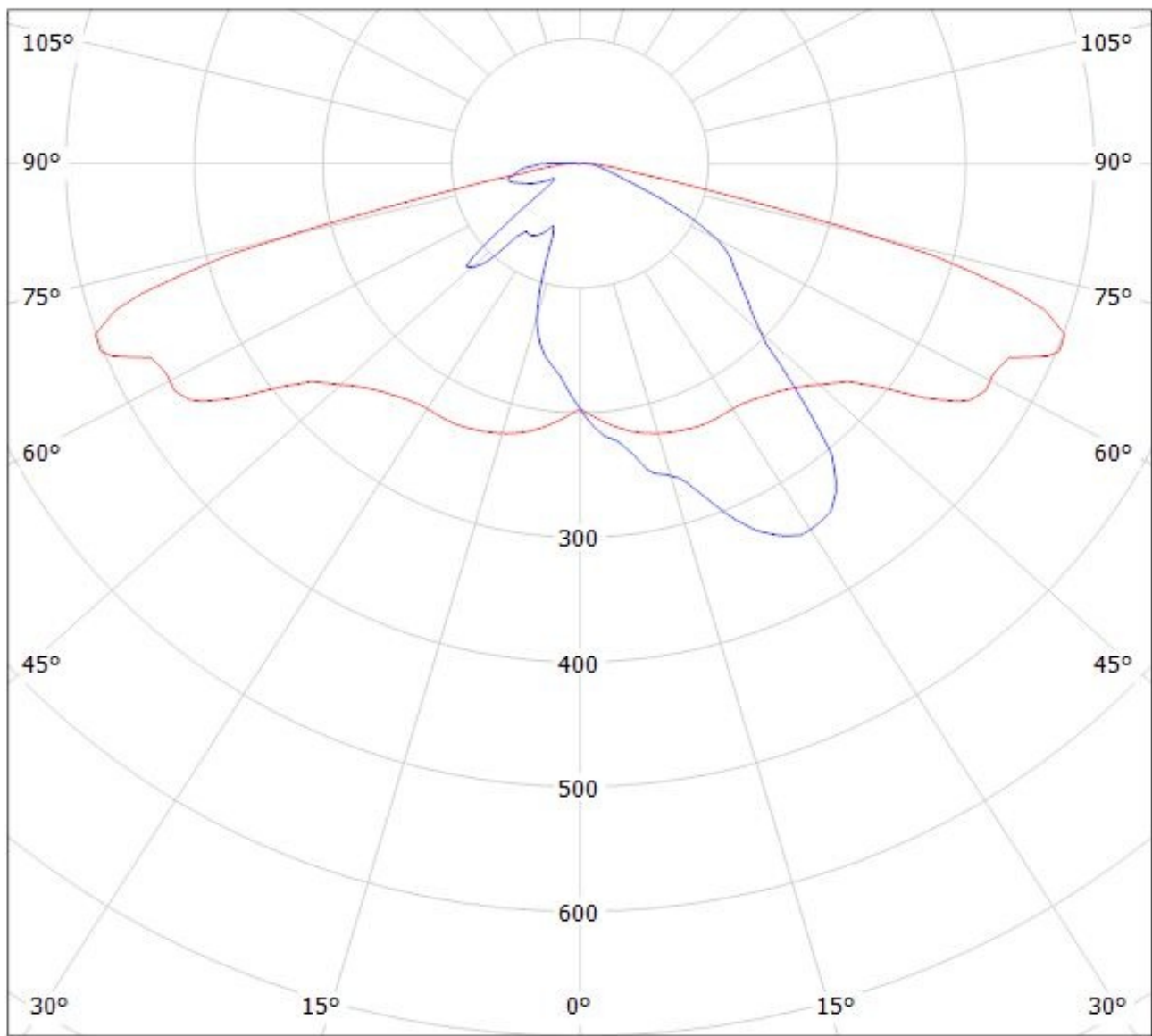

cd/klm

— C0 - C180

— C90 - C270

Luminaire: LEDiL C12726&CA12889_STRADA-SQ-T-DWC (Luxeon M) Efficiency=94%
Lamps: 1 x Luxeon M (360lm@250mA)

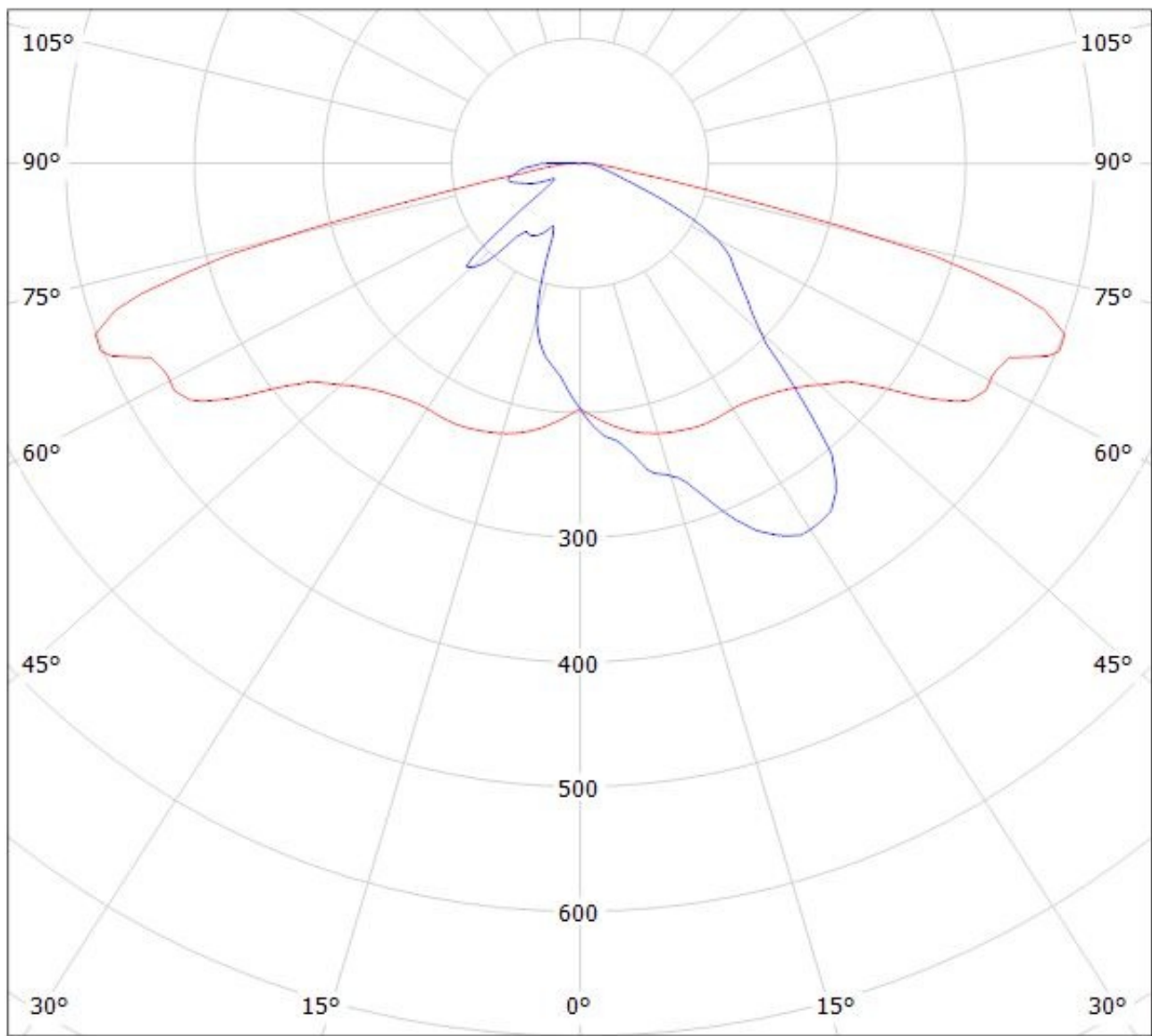

cd/klm

— C0 - C180

— C90 - C270

Luminaire: LEDiL Oy C13118_&_CA13119_STRADA-SQ-A-T-LuxM (Luxeon M 362lm @ 250mA) Efficiency=93%
Lamps: 1 x Luxeon M 362lm @ 250mA

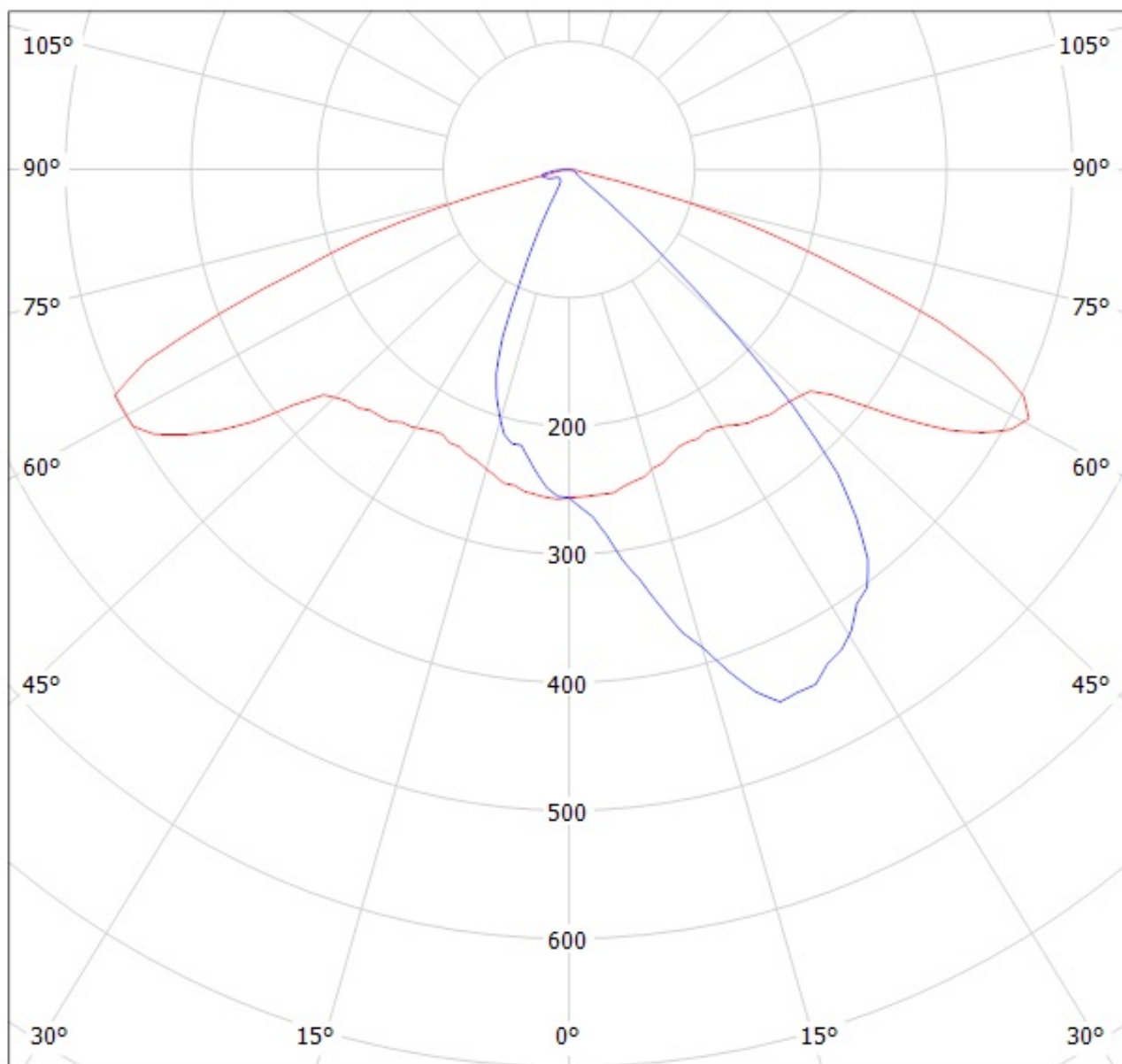

cd/klm

— C0 - C180 — C90 - C270

Luminaire: LEDiL Oy C13118_&_CA13119_STRADA-SQ-A-T-LuxM (Luxeon M 362lm @ 250mA) Efficiency=93%
Lamps: 1 x Luxeon M 362lm @ 250mA

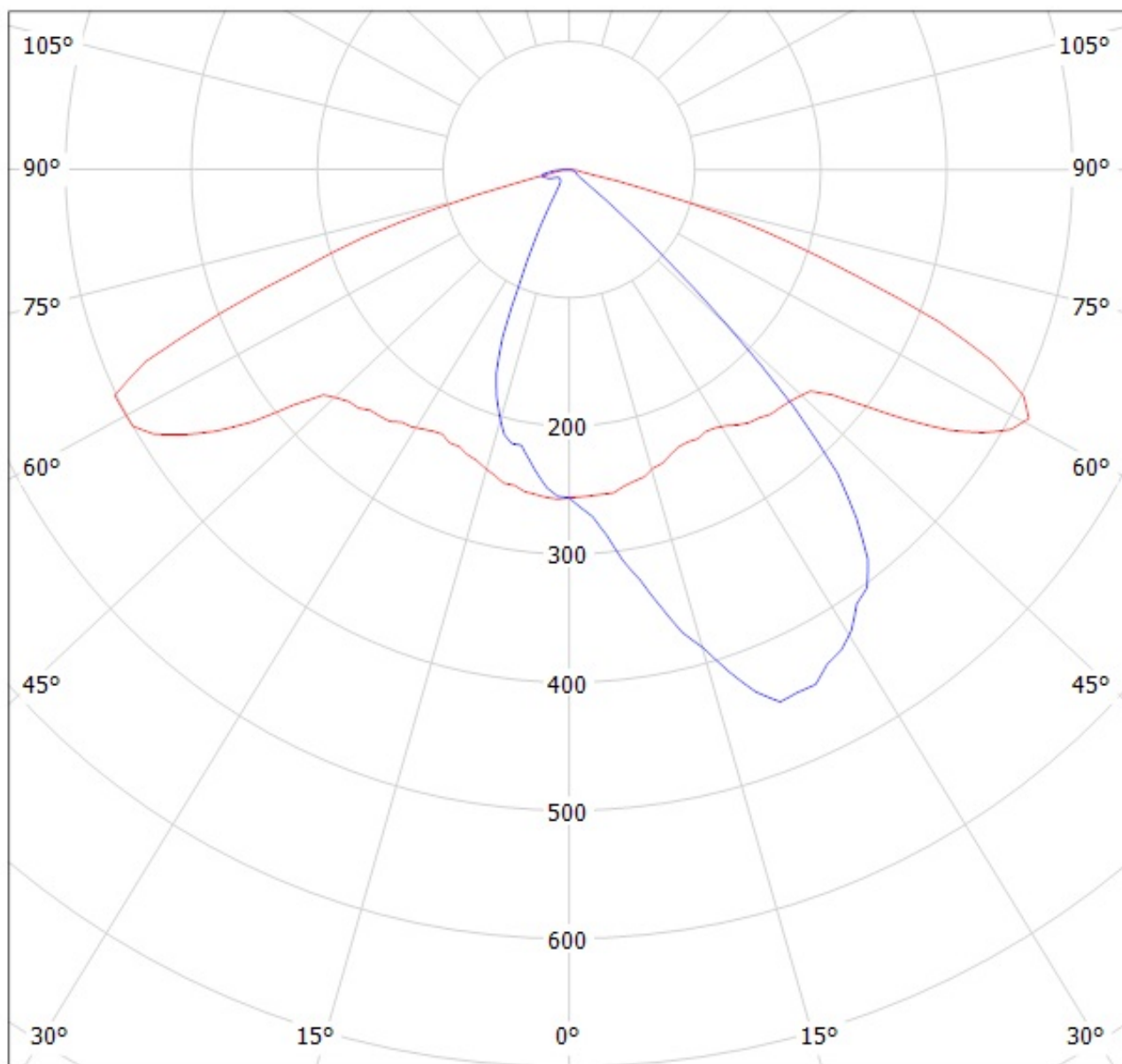

cd/klm

— C0 - C180 — C90 - C270

LEDiL Oy CA13509_STRADA-SQ-T2_(LUXEON_M) Eff.93.1% / LDC (Polar)

Luminaire: LEDiL Oy CA13509_STRADA-SQ-T2_(LUXEON_M) Eff.93.1%

Lamps: 1 x LUXEON_M_350.373lm@250mA_CCT=4092K_P=2.73116W_I=249.9mA

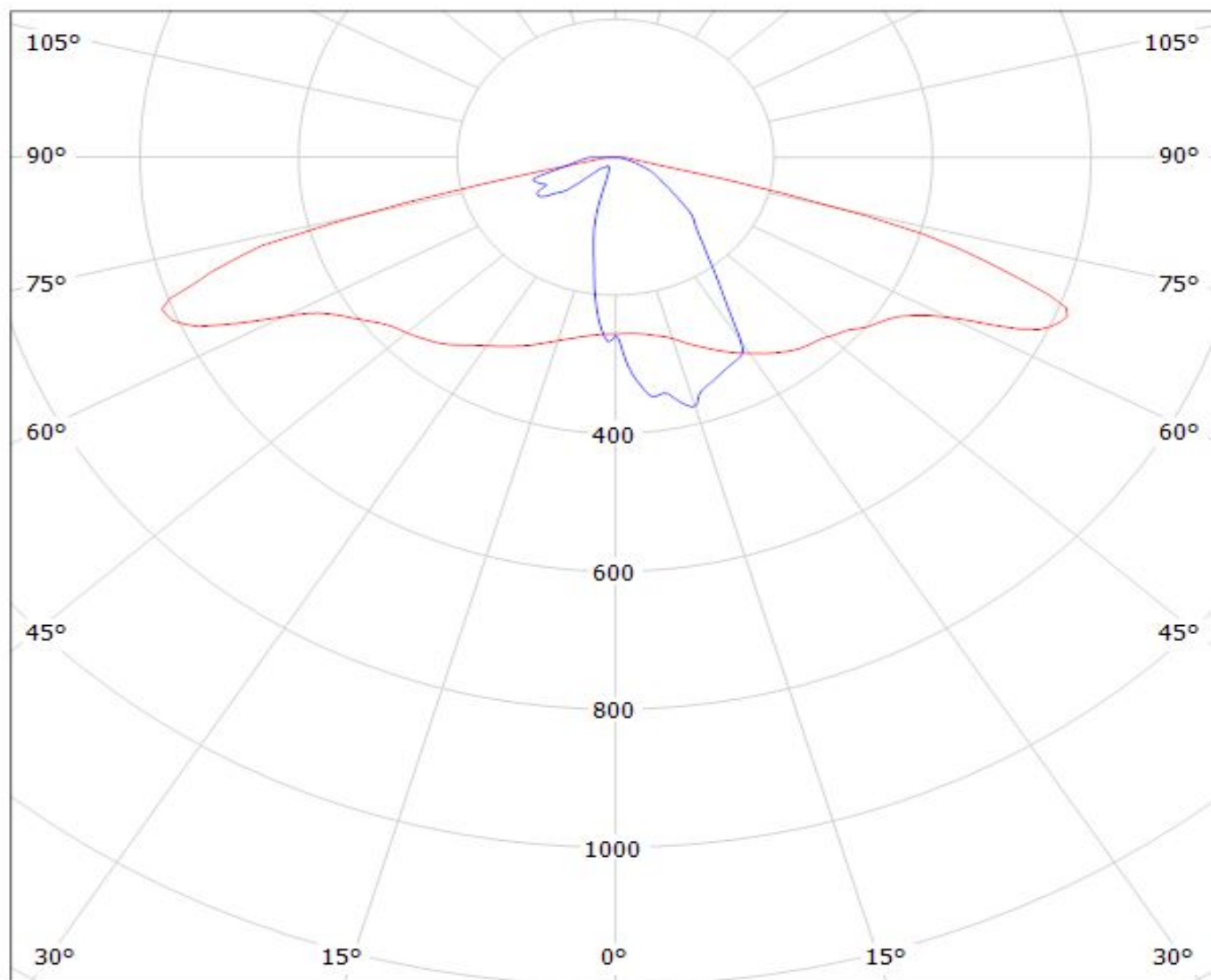

cd/klm

— C0 - C180

— C90 - C270

$\eta = 93\%$

LEDiL Oy CA13688_STRADA-SQ-T3_(LUXEON_M) Eff.91.7% / LDC (Polar)

Luminaire: LEDiL Oy CA13688_STRADA-SQ-T3_(LUXEON_M) Eff.91.7%

Lamps: 1 x LUXEON_M_350.373lm@250mA_CCT=4092K_P=2.73116W_I=249.9mA

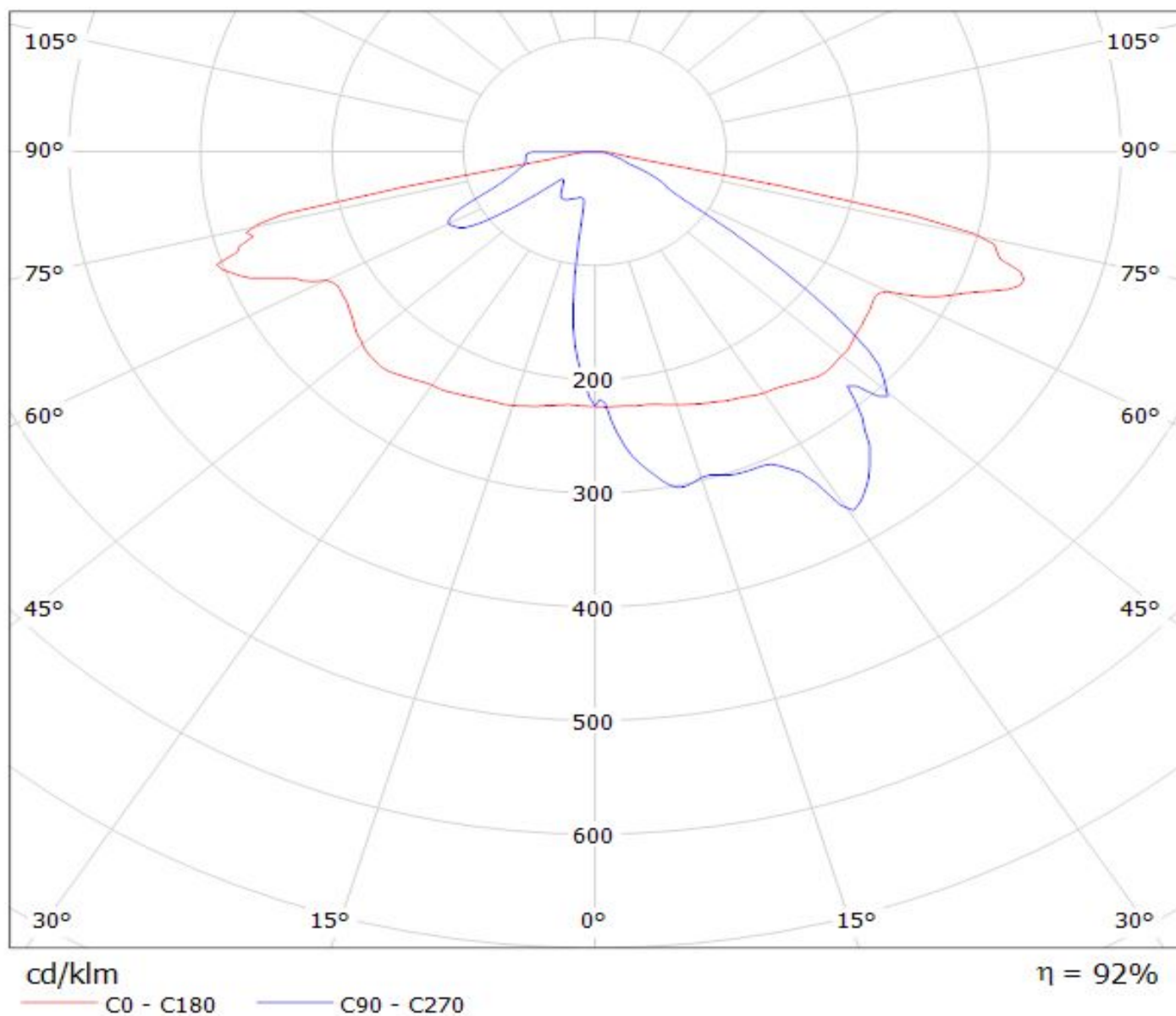

LEDiL Oy C13866_STRADA-SQ-CY_(LUXEON_M) Eff.94.0% / LDC (Polar)

Luminaire: LEDiL Oy C13866_STRADA-SQ-CY_(LUXEON_M) Eff.94.0%

Lamps: 1 x LUXEON_M_359.1lm@250mA_CCT=4092K_P=2.73016W_I=249.9mA

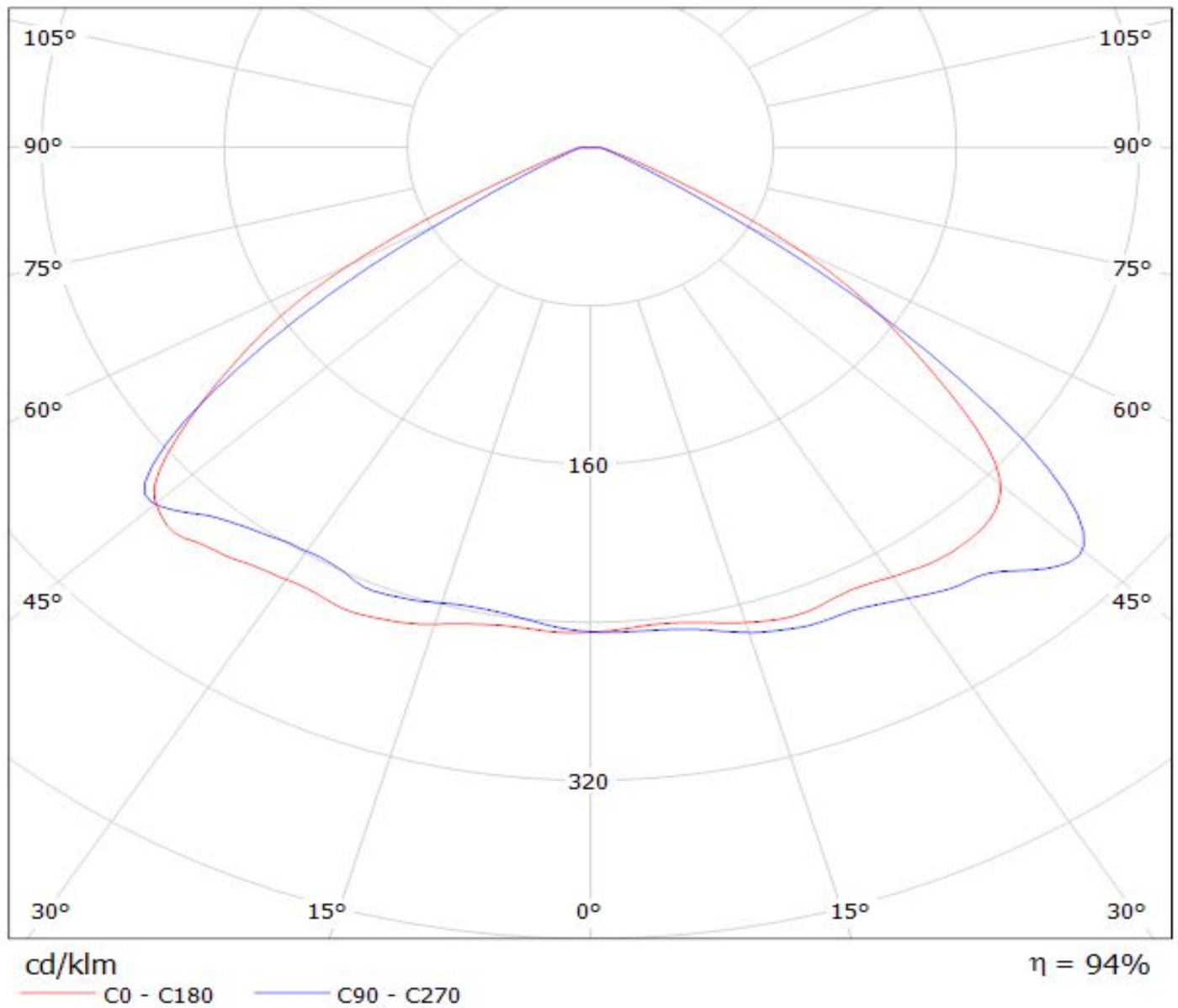

Luminaire: LEDIL OY C12727_STRADA-SQ-VSM (Luxeon M) Efficiency=95%
Lamps: 1 x Luxeon M (360lm@250mA)

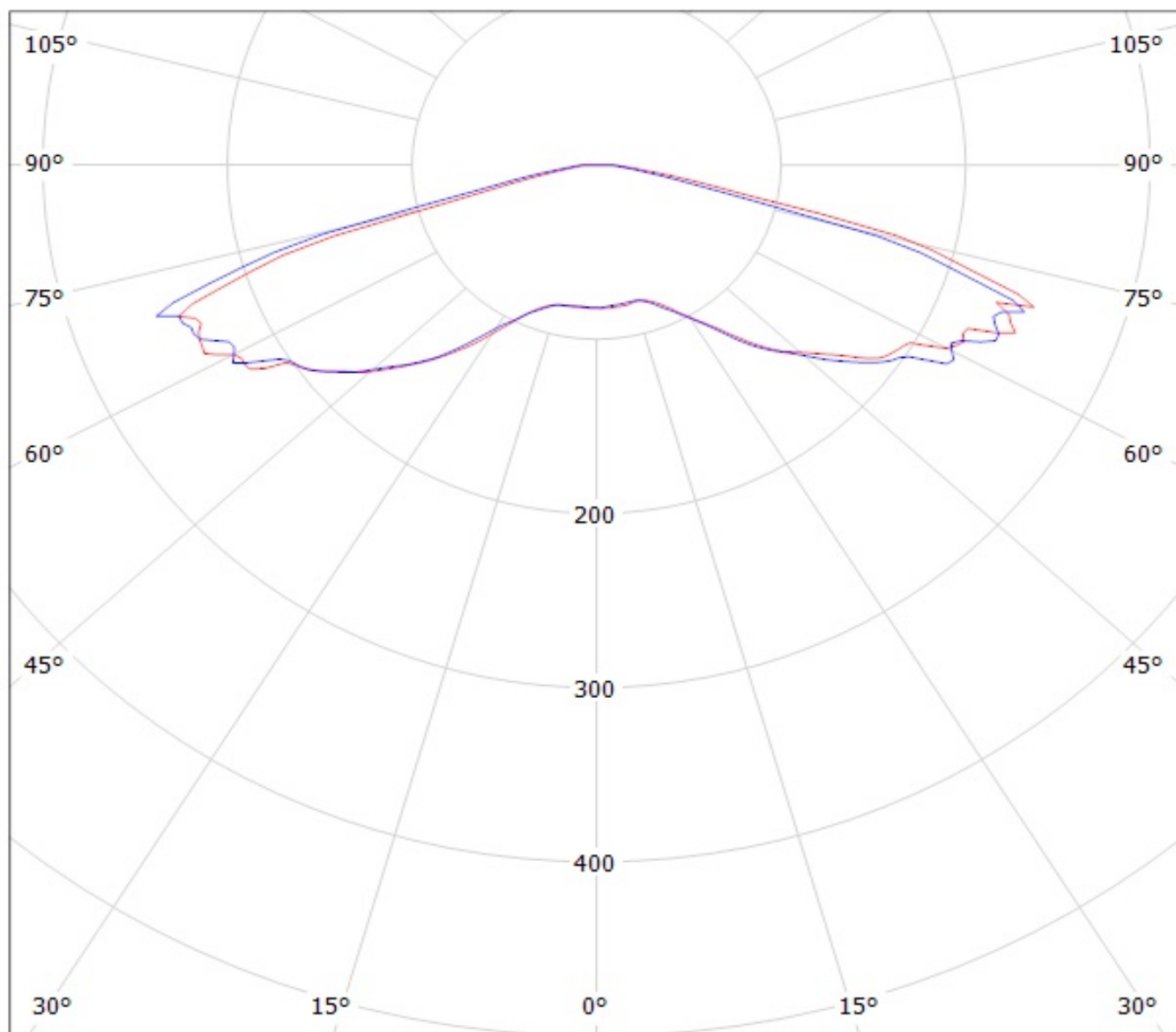

cd/klm

— C0 - C180

— C90 - C270

Luminaire: LEDIL OY C12727_STRADA-SQ-VSM (Luxeon M) Efficiency=95%
Lamps: 1 x Luxeon M (360lm@250mA)

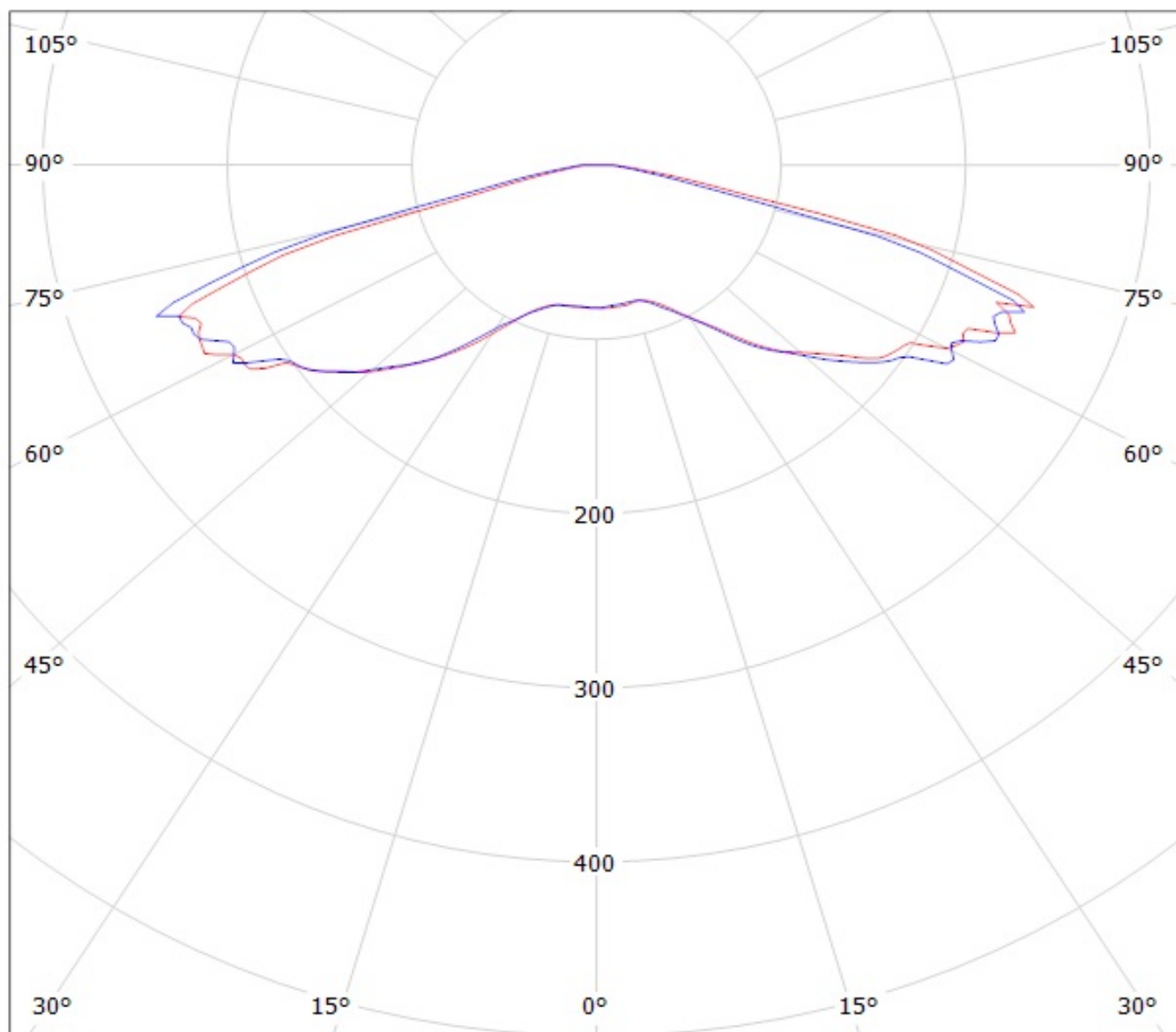

cd/klm

— C0 - C180

— C90 - C270