

ITEM	Q'TY	PART NUMBER	PART DESCRIPTION
1	1	FLPR-XX	Flexible Light Pipe Adapter, 90°, w/LED, See page 2 & 3.
2	1	LC-XX.X	Flexible Light-Pipe Lens Cap Assembly

REV.	DESCRIPTION	DATE	APPROVED
D	Added Shipping Note and Tolerance Table	04/17/06	M. C.
E	Changed Length From 2.5 to 0.5 at "L" Table	02/12/07	M. C.
F	Updated FLPC Hidden View and BOM	08/27/08	M. C.
G	LED Data Update	11/18/11	T. Y.
H	RP note added	02/09/12	T. Y.
J	Added the 3HC-F LED to page 2	02/09/12	T. Y.
K	Updated Table For Length "L"	11/15/12	T. Y.

NOTE: FLPR ADAPTER SHIPPED NON-ASSEMBLED

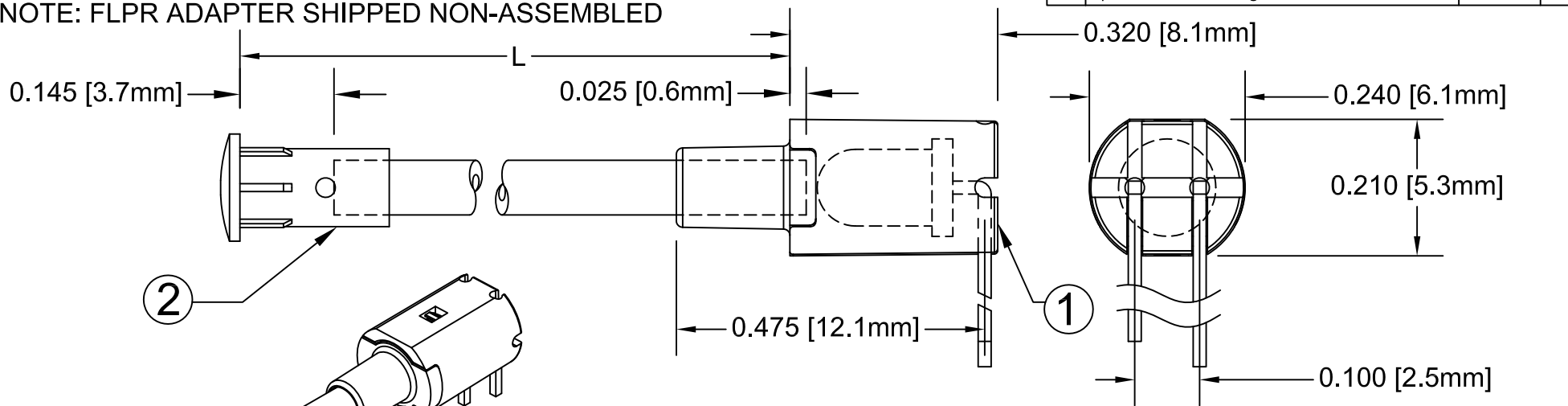

" L " *	Tolerance
1.0" ~ 16.0"	±0.050"
16.1" ~ 40.0"	±0.15"
40.1" ~ 80.0"	±0.30"
80.1" ~ 3,940.0"	±0.5%

* Available in 0.1" increments only

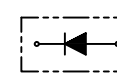

SINGLE COLOR LED
SHORT LEAD CATHODE

Add -RP suffix for Reverse Polarity

BI-COLOR LED'S

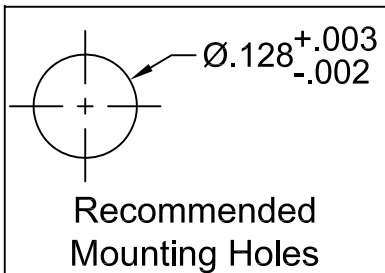
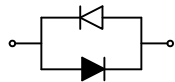

SHORT LEAD CATHODE	LED PART NO.	LONG LEAD CATHODE
RED	3xBCC-F	GREEN
YELLOW	3xBCC-Y/G-F	GREEN
RED	3xBCC-R/Y-F	YELLOW
AMBER	3xBCC-A/G-F	GREEN

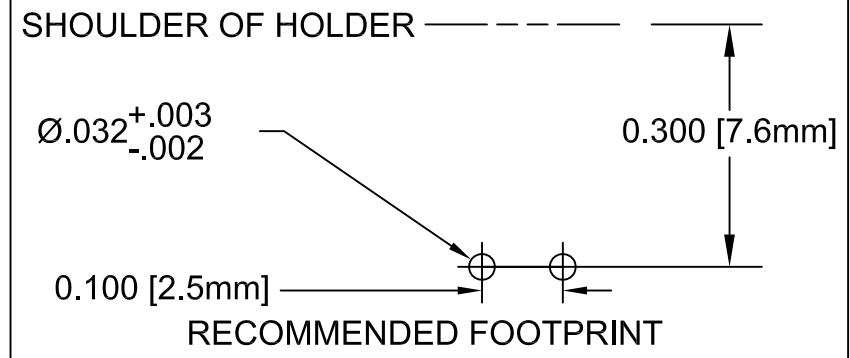

ABSOLUTE MAXIMUM RATINGS (Ta=25°C)

REVERSE VOLTAGE	_____	5V
REVERSE CURRENT	_____	100uA
OPERATING TEMPERATURE RANGE	_____	-25° C - 85° C
STORAGE TEMPERATURE	_____	-30° C - 100° C
LEAD SOLDERING TEMPERATURE(1/16" FROM BODY)	_____	260° C FOR 5 SECONDS

STANDARD TOLERANCE (UNLESS OTHERWISE SPECIFIED)	
DECIMALS	ANGULAR
.X ±.1	X° ± 1°
.XX ±.02	
.XXX ±.010	

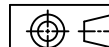

DESIGNED: Shane Irving	DATE: 02/09/99
CHECKED: M. Chen	DATE: 07/03/02

BIVAR®



4 THOMAS, IRVINE, CA. 92618
TEL: (949) 951-8808 FAX: (949) 951-3974

TITLE: FLEXIBLE LIGHT-PIPE ASSY
RIGHT ANGLE, 3mm LENS CAP W/LED

PART NO: FLPRX.X-XX	REVISION: K
CAGE CODE : 32559	SHEET # 1 OF 3
CAD GENERATED DOCUMENT, DO NOT MEASURE DRAWING.	



REV.	DESCRIPTION	DATE	APPROVED
	SEE SHEET#1.		

Assy Part No.	LED Part No.	Chip			Lens Appearance	Absolute Max. Ratings				Electro-Optical Data @ 20mA			Viewing Angle 2 θ 1/2 (Deg)
		Material	Peak Wave Length λ_p (nm)	Emitted Color		$\Delta\lambda$ (nm)	Pd (mW)	If (mA)	Peak If(mA)	Vf (V)		Iv (mcd)	
										TYP	MAX	TYP	
FLPRX.X-SG	3SGC-F	GaP/GaP	568	SUPER GREEN	WATER CLEAR	-	80	30	150	2.1	2.8	50	20
FLPRX.X-SY	3SYC-F	GaAsP/GaP	590	SUPER YELLOW	WATER CLEAR	-	85	30	150	2.0	2.8	50	20
FLPRX.X-SA	3SAC-F	AlGaInP	605	SUPER AMBER	WATER CLEAR	-	100	30	150	1.8	2.4	300	20
FLPRX.X-SR	3SRC-F	GaAiAsP/GaAs	645	SUPER RED	WATER CLEAR	-	70	30	150	1.7	2.4	60	20
FLPRX.X-UBW.6K	3UBWC-0.6K-F	GaN/SiC	470	BLUE	WATER CLEAR	-	150	25	70	4.0	4.5	400	20
FLPRX.X-UT	3UTC-F	GaN/SiC	500	TURQUOISE	WATER CLEAR	-	70	30	150	3.5	4.0	800	20
FLPRX.X-UG	3UGC-F	AlGaInP	570	GREEN	WATER CLEAR	-	100	30	150	2.1	2.4	200	20
FLPRX.X-SUG	3SUGC-F	AlGaInP	570	GREEN	WATER CLEAR	-	100	30	150	2.1	2.4	300	20
FLPRX.X-UY	3UYC-F	AlGaInP	590	YELLOW	WATER CLEAR	-	85	30	150	2.0	2.4	300	20
FLPRX.X-SUY	3SUYC-F	AlGaInP	590	YELLOW	WATER CLEAR	-	85	30	150	2.0	2.4	400	20
FLPRX.X-UUY	3UUYC-F	AlGaInP	590	YELLOW	WATER CLEAR	-	85	30	150	2.0	2.4	600	20
FLPRX.X-UO	3UOC-F	AlGaInP	625	ORANGE	WATER CLEAR	-	100	30	150	1.8	2.4	300	20
FLPRX.X-SUO	3SUOC-F	AlGaInP	625	ORANGE	WATER CLEAR	-	100	30	150	1.8	2.4	400	20
FLPRX.X-UR	3URC-F	GaAlAs/GaAs	645	RED	WATER CLEAR	-	60	30	150	1.7	2.4	200	20
FLPRX.X-SUR	3SURC-F	AlGaInP	640	RED	WATER CLEAR	-	70	30	150	1.8	2.4	200	20
FLPRX.X-H	3HC-F	GaAsP/GaP	625	RED	WATER CLEAR	-	80	30	150	2.0	2.8	50	20

STANDARD TOLERANCE (UNLESS OTHERWISE SPECIFIED) $\pm 10\%$ ALL VALUES		 BIVAR [®] 4 THOMAS, IRVINE, CA. 92618 TEL: (949) 951-8808 FAX: (949) 951-3974	
ANGULAR X° \pm 5°			
		TITLE: FLEXIBLE LIGHT-PIPE ASSY RIGHT ANGLE, 3mm LENS CAP W/LED	
DESIGNED: David Green	DATE: 06/09/03	PART NO: FLPRX.X-XX	REVISION: K
CHECKED: M. Chen	DATE: 06/09/03	CAGE CODE : 32559	SHEET # 2 OF 3
CAD GENERATED DOCUMENT, DO NOT MEASURE DRAWING.			

REV.	DESCRIPTION	DATE	APPROVED
	SEE SHEET#1.		

Assy Part No.	LED Part No.	Chip			Lens Appearance	Absolute Max. Ratings				Electro-Optical Data @ 20mA			Viewing Angle 2θ ½ (Deg)
		Material	Peak Wave Length λp(nm)	Emitted Color		Δλ (nm)	Pd (mW)	If (mA)	Peak If(mA)	Vf (V)		Iv (mcd)	
										TYP	MAX	TYP	
FLPRX.X-BC	3BCC-F	GaAsP/GaP	625	RED	WATER CLEAR	35	80	30	150	2.0	2.8	8	40
		GaP/GaP	568	GREEN		30	80	30	150	2.1	2.8	8	
FLPRX.X-BC-Y/G	3BCC-Y/G-F	GaAsP/GaP	590	YELLOW	WATER CLEAR	35	80	30	150	2.0	2.8	6	40
		GaP/GaP	568	GREEN		30	80	30	150	2.1	2.8	8	
FLPRX.X-BC-R/Y	3BCC-R/Y-F	GaAsP/GaP	625	RED	WATER CLEAR	35	80	30	150	2.0	2.8	8	40
		GaP/GaP	590	YELLOW		30	80	30	150	2.0	2.8	6	
FLPRX.X-BC-A/G	3BCC-A/G-F	GaAsP/GaP	605	AMBER	WATER CLEAR	35	80	30	150	2.0	2.8	6	40
		GaP/GaP	568	GREEN		30	80	30	150	2.1	2.8	8	
FLPRX.X-SBC	3SBCC-F	GaAlAs/GaAs	645	SUPER RED	WATER CLEAR	-	70	30	150	1.7	2.4	100	20
		GaP/GaP	568	SUPER GREEN		-	80	30	150	2.1	2.8	60	
FLPRX.X-SBC-Y/G	3SBCC-Y/G-F	InGaAlP	585	SUPER YELLOW	WATER CLEAR	-	85	20	160	2.1	2.4	15	40
		GaP/GaP	565	SUPER GREEN		-	80	20	160	2.1	2.8	5	
FLPRX.X-SBC-R/Y	3SBCC-R/Y-F	GaAlAs/GaAs	645	SUPER RED	WATER CLEAR	-	70	30	150	1.7	2.4	100	20
		AlGaInP	590	SUPER YELLOW		-	85	30	150	2.0	2.4	300	

STANDARD TOLERANCE (UNLESS OTHERWISE SPECIFIED) ±10% ALL VALUES		 BIVAR [®] 4 THOMAS, IRVINE, CA. 92618 TEL: (949) 951-8808 FAX: (949) 951-3974	
ANGULAR X° ± 5°		 TITLE: FLEXIBLE LIGHT-PIPE ASSY RIGHT ANGLE, 3mm LENS CAP W/LED	
DESIGNED: David Green	DATE: 06/09/03	PART NO: FLPRX.X-XX	REVISION: K
CHECKED: M. Chen	DATE: 06/09/03	CAGE CODE : 32559	SHEET # 3 OF 3
CAD GENERATED DOCUMENT, DO NOT MEASURE DRAWING.			