

03 030798-1

Circular connectors with threaded joint M16 acc. to IEC 61076-2-106, IP40/IP67/IP68



Chassis socket acc. to IEC 61076-2-106 and AISG specification, IP 68, with threaded joint and ground contact, for printed circuit boards, for back side mounting

03

030798-1

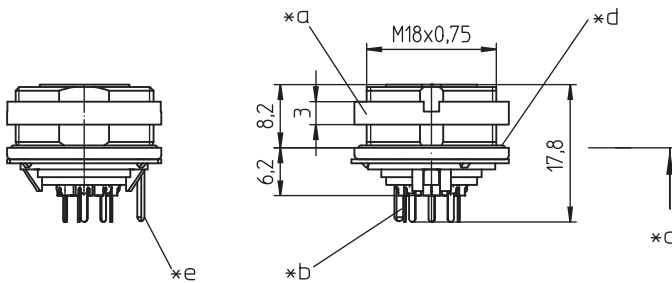
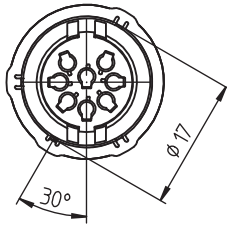
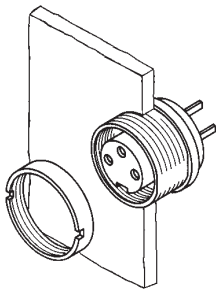

Environmental conditions

Temperature range -40 °C/+85 °C

Materials

Insulating body	PA GF, V-0 according to UL94
Contact bush	CuZn, silver-plated and flash gold-plated, tin-plated in solder area
Ground contact	CuZn, pre-nickel and tin-plated
Housing	Zn diecast, pre-copper and nickel-plated
Ring screw	CuZn, nickel-plated
Seal	NBR

Mechanical data

Insertion force/contact	≤ 5.0 N ¹
Withdrawal force/contact	≥ 1.2 N ¹
Protection class	IP68 ²





¹ measured with a polished steel pin, nominal thickness 1.5 mm

² according to IEC DIN EN 60529, only in locked condition with an appropriate counterpart; IPX8 requirements under agreement between manufacturer and user

Electrical data (at T_{amb} 20 °C)

*C Contact resistance	≤ 5 mΩ
Rated current	5 A (T _{amb} 40 °C)
Rated voltage	100 V (with pollution degree 1) 32 V (with pollution degree 2)
Rated impulse voltage	500 V
Material group	II (IEC)/I (UL) (CTI ≥ 550)
Overvoltage category	I
Insulation resistance	> 100 MΩ

Associated products

Counterparts			
 0331	 0332	 0332-1	
 033200	 0365	 036500	
Accessories			
 0322 C 16	 0381	 038199	
 0384	 0385	 038799	

03

030798-1

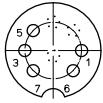
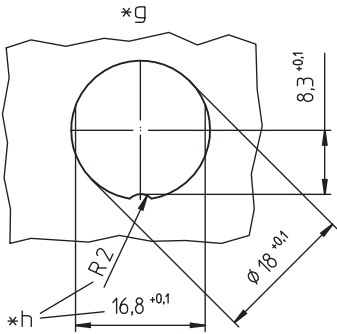
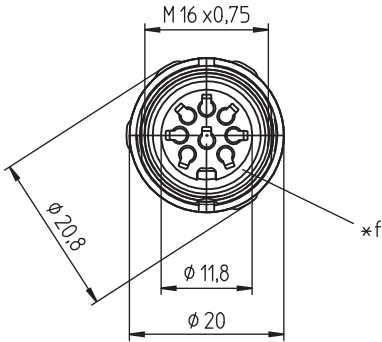

*j

030798-1 05-3

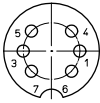

-

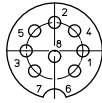

08-a

030798-1 08-1

03

030798-1

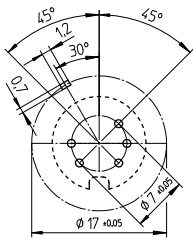

*h

030798-1 05-3

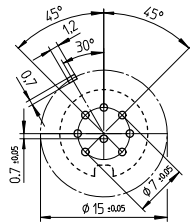

08-a

030798-1 08-1

- *a nut enclosed separately
- *b for bore hole in printed circuit board $\varnothing 1$ mm
- *c mounting direction
- *d O-ring gasket
- *e ground contact
- *f flat gasket
- *g port in mounting plate
- *h anti-rotation, alternative execution
- *i pin configuration according to AISG C485

03

030798-1

Designation	Pole Number	PU (Pieces)	MDQ (Pieces)
030798-1 05-3	8	50	100
030798-1 08-1	8	50	100

Packaging:

in a cardboard box