

| | | | |
|------|---------|-----|----------|
| REV | CONTENT | CHK | DATE |
| V0.0 | CONTENT | YL | 22.11.21 |

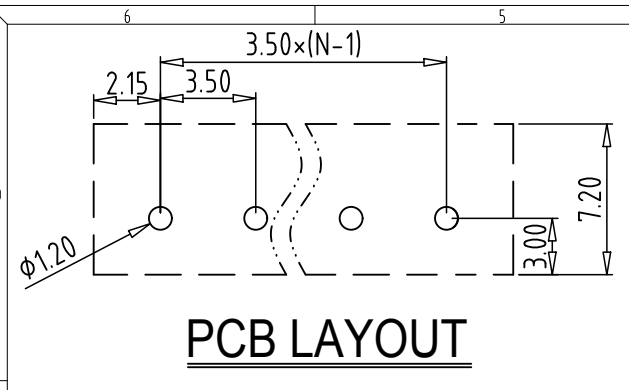

Electrical :

| | | |
|--|---------------|------|
| | UL | IEC |
| 1. Rated Voltage : | 300V | 250V |
| 2. Rated Current : | 8A | 7A |
| 3. Withstanding Voltage : | AC1600V/1Min; | |
| 4. Operating Temperature : | -40°C~+105°C; | |
| 5. RoHS Compliance; | | |
| 6. "★" is the key quality control point. | | |

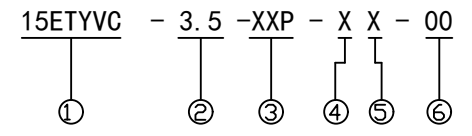
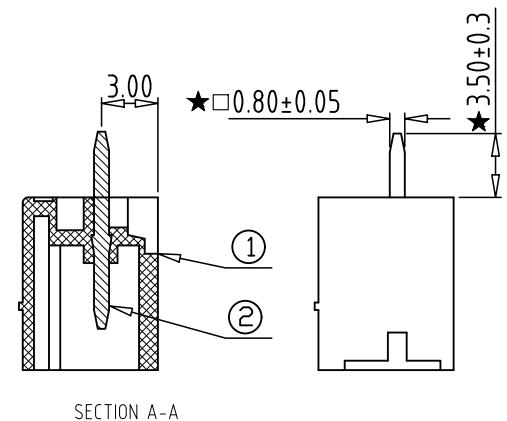
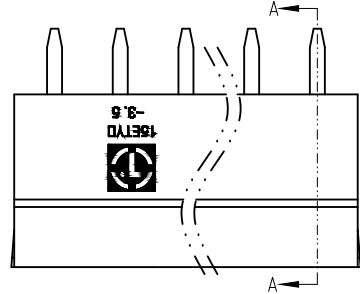
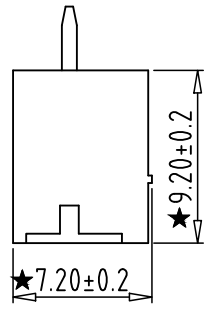
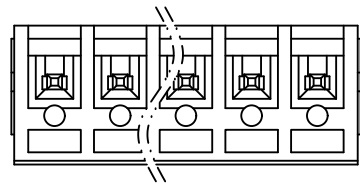

- ① Series NO.
- ② Pitch
- ③ Poles
- ④ 1 Single Pitch
2 Double Pitch
- ⑤ Color: 1 Grey
2 Blue
3 Black
4 Green
5 Orange
6 Red
7 Transparent
8 Yellow
9 White
- ⑥ Customer Request: 00--Standard

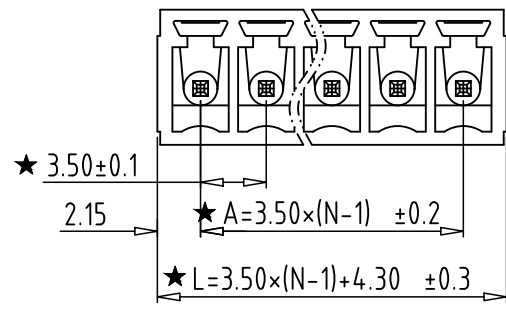

| Total Pitch Tolerances in mm | | | | | | | | | | Nominal dimension range in mm | | | | | | | | | | ⊥ | | ≡ | | — | | // | |
|------------------------------|-------|-------|------|-------|-------|-------|-------|-------|-------|-------------------------------|-------|-------|-------|-------|-------|-------|-------|------|------|-----|------|-----|------|-----|------|-----|------|
| over | over | over | over | over | over | over | over | over | over | over | over | over | over | over | over | over | over | over | over | 0 | over | 0 | over | 0 | over | 0 | over |
| 0 | 30 | 53 | 70 | 90 | 115 | 150 | 250 | 350 | 500 | 0 | 30 | 53 | 70 | 90 | 115 | 150 | 200 | 250 | 320 | 0 | 10 | 0 | 100 | 0 | 100 | 0 | 150 |
| ±0.18 | ±0.20 | ±0.25 | ±0.3 | ±0.35 | ±0.44 | ±0.60 | ±0.70 | ±0.85 | ±0.20 | ±0.25 | ±0.30 | ±0.35 | ±0.44 | ±0.55 | ±0.70 | ±0.80 | ±0.90 | 0.2 | 0.3 | 0.3 | 0.3 | 0.2 | 0.3 | 0.2 | 0.3 | 0.2 | 0.5 |

| | | | | | |
|--|--------------|-------------|----------|-----------------------|--------------------------|
| 2 | PIN | XX | N | BRASS | Tin Plated |
| 1 | HOUSING | XX | 1 | PA66 UL94V-0 | SEE NOTE |
| ITEM | NAME OF PART | NO. OF PART | Q'TY | MATERIAL | NOTE |
| DWG. | YL | DATE | 22.11.21 | SIZE | A4 UNITS mm SHEET/OF 1/1 |
| CHK. | DATE | | SCALE | 1:1 | |
| APP. | DATE | | NAME | 15ETYVC-3.5-XXP-XX-00 | |
| 拓宜(上海)工控电器设备有限公司 Topone(Shanghai) Industrial Control Electrical Equipment Co., LTD. | | | DWGNO. | XXXXX | |