

Dual Bias Resistor Transistors

NPN Silicon Surface Mount Transistors with Monolithic Bias Resistor Network

The BRT (Bias Resistor Transistor) contains a single transistor with a monolithic bias network consisting of two resistors; a series base resistor and a base-emitter resistor. These digital transistors are designed to replace a single device and its external resistor bias network. The BRT eliminates these individual components by integrating them into a single device. In the MMUN5211 DW series, two BRT devices are housed in the SOT-363 package which is ideal for low power surface mount applications where board space is at a premium.

- Simplifies Circuit Design
- Reduces Board Space
- Reduces Component Count
- We declare that the material of product compliance with RoHS requirements.

MMUN5211DW Series

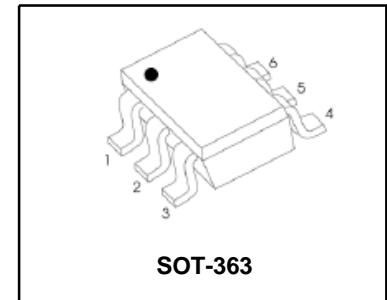

MAXIMUM RATINGS (T_A = 25°C unless otherwise noted, common for Q₁ and Q₂)

Rating	Symbol	Value	Unit
Collector-Base Voltage	V _{CBO}	50	Vdc
Collector-Emitter Voltage	V _{CEO}	50	Vdc
Collector Current	I _C	100	mAdc

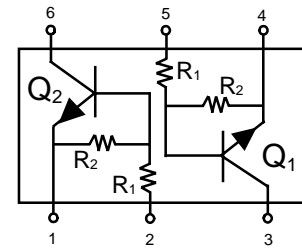

THERMAL CHARACTERISTICS

Characteristic (One Junction Heated)	Symbol	Max	Unit
Total Device Dissipation T _A = 25°C	P _D	187 (Note 1.) 256 (Note 2.)	mW
Derate above 25°C		1.5 (Note 1.) 2.0 (Note 2.)	mW/°C
Thermal Resistance – Junction-to-Ambient	R _{θJA}	670 (Note 1.) 490 (Note 2.)	°C/W
Characteristic (Both Junctions Heated)	Symbol	Max	Unit
Total Device Dissipation T _A = 25°C	P _D	250 (Note 1.) 385 (Note 2.)	mW
Derate above 25°C		2.0 (Note 1.) 3.0 (Note 2.)	mW/°C
Thermal Resistance – Junction-to-Ambient	R _{θJA}	493 (Note 1.) 325 (Note 2.)	°C/W
Thermal Resistance – Junction-to-Lead	R _{θJL}	188 (Note 1.) 208 (Note 2.)	°C/W
Junction and Storage Temperature	T _J , T _{stg}	-55 to +150	°C

MARKING DIAGRAM

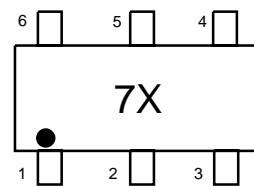

7X = Device Marking
(See Page 2)

DEVICE MARKING INFORMATION

See specific marking information in the device marking table on page 2 of this data sheet.

1. FR-4 @ Minimum Pad 2. FR-4 @ 1.0 x 1.0 inch Pad

DEVICE MARKING , RESISTOR VALUES AND ORDERING INFORMATION

Device	Package	Marking	R1(K)	R2(K)	Shipping
MMUN5211DW	SOT-363	7A	10	10	3000/Tape&Reel
MMUN5212DW	SOT-363	7B	22	22	3000/Tape&Reel
MMUN5213DW	SOT-363	7C	47	47	3000/Tape&Reel
MMUN5214DW	SOT-363	7D	10	47	3000/Tape&Reel
MMUN5215DW	SOT-363	7E	10	∞	3000/Tape&Reel
MMUN5216DW	SOT-363	7F	4.7	∞	3000/Tape&Reel
MMUN5230DW	SOT-363	7G	1	1	3000/Tape&Reel
MMUN5231DW	SOT-363	7H	2.2	2.2	3000/Tape&Reel
MMUN5232DW	SOT-363	7J	4.7	4.7	3000/Tape&Reel
MMUN5233DW	SOT-363	7K	4.7	47	3000/Tape&Reel
MMUN5234DW	SOT-363	7L	22	47	3000/Tape&Reel
MMUN5235DW	SOT-363	7M	2.2	47	3000/Tape&Reel
MMUN5238DW	SOT-363	7Q	2.2	∞	3000/Tape&Reel
MMUN5241DW	SOT-363	7T	100	∞	3000/Tape&Reel



ELECTRICAL CHARACTERISTICS ($T_A = 25^\circ\text{C}$ unless otherwise noted, common for Q_1 and Q_2),(Continued)

Parameter	Symbol	Min.	Max.	Unit	
DC Current Gain at $V_{CE} = 10\text{ V}$, $I_C = 5\text{ mA}$	MMUN5211DW	h_{FE}	35	-	-
	MMUN5212DW	h_{FE}	60	-	-
	MMUN5213DW	h_{FE}	80	-	-
	MMUN5214DW	h_{FE}	80	-	-
	MMUN5215DW	h_{FE}	160	-	-
	MMUN5216DW	h_{FE}	160	-	-
	MMUN5230DW	h_{FE}	3	-	-
	MMUN5231DW	h_{FE}	8	-	-
	MMUN5232DW	h_{FE}	15	-	-
	MMUN5233DW	h_{FE}	80	-	-
	MMUN5234DW	h_{FE}	80	-	-
	MMUN5235DW	h_{FE}	80	-	-
	MMUN5238DW	h_{FE}	160	-	-
MMUN5241DW	h_{FE}	160	-	-	
Collector Base Cutoff Current at $V_{CB} = 50\text{ V}$	I_{CBO}	-	100	nA	
Collector Emitter Cutoff Current at $V_{CE} = 50\text{ V}$	I_{CEO}	-	500	nA	
Emitter Base Cutoff Current at $V_{EB} = 6\text{ V}$	MMUN5211DW	I_{EBO}	-	0.5	mA
	MMUN5212DW	I_{EBO}	-	0.2	mA
	MMUN5213DW	I_{EBO}	-	0.1	mA
	MMUN5214DW	I_{EBO}	-	0.2	mA
	MMUN5215DW	I_{EBO}	-	0.9	mA
	MMUN5216DW	I_{EBO}	-	1.9	mA
	MMUN5230DW	I_{EBO}	-	4.3	mA
	MMUN5231DW	I_{EBO}	-	2.3	mA
	MMUN5232DW	I_{EBO}	-	1.5	mA
	MMUN5233DW	I_{EBO}	-	0.18	mA
	MMUN5234DW	I_{EBO}	-	0.13	mA
	MMUN5235DW	I_{EBO}	-	0.2	mA
	MMUN5238DW	I_{EBO}	-	4	mA
MMUN5241DW	I_{EBO}	-	0.1	mA	
Collector Base Breakdown Voltage at $I_C = 10\text{ }\mu\text{A}$	$V_{(BR)CBO}$	50	-	V	
Collector Emitter Breakdown Voltage at $I_C = 2\text{ mA}$	$V_{(BR)CEO}$	50	-	V	
Collector Emitter Saturation Voltage at $I_C = 10\text{ mA}$, $I_B = 0.3\text{ mA}$ at $I_C = 10\text{ mA}$, $I_B = 5\text{ mA}$ at $I_C = 10\text{ mA}$, $I_B = 1\text{ mA}$		V_{CEsat}	-	0.25	V
	MMUN5230DW	V_{CEsat}	-	0.25	V
	MMUN5231DW	V_{CEsat}	-	0.25	V
	MMUN5215DW	V_{CEsat}	-	0.25	V
	MMUN5216DW	V_{CEsat}	-	0.25	V
	MMUN5232DW	V_{CEsat}	-	0.25	V
	MMUN5233DW	V_{CEsat}	-	0.25	V
	MMUN5234DW	V_{CEsat}	-	0.25	V
	MMUN5235DW	V_{CEsat}	-	0.25	V
	MMUN5238DW	V_{CEsat}	-	0.25	V



ELECTRICAL CHARACTERISTICS ($T_A = 25^\circ\text{C}$ unless otherwise noted, common for Q₁ and Q₂.) (Continued)

Parameter	Symbol	Min.	Max.	Unit		
Output Voltage (on) at $V_{CC} = 5\text{ V}$, $V_B = 2.5\text{ V}$, $R_L = 1\text{ K}\Omega$	MMUN5211DW	V_{OL}	-	0.2	V	
	MMUN5212DW	V_{OL}	-	0.2	V	
	MMUN5214DW	V_{OL}	-	0.2	V	
	MMUN5215DW	V_{OL}	-	0.2	V	
	MMUN5216DW	V_{OL}	-	0.2	V	
	MMUN5230DW	V_{OL}	-	0.2	V	
	MMUN5231DW	V_{OL}	-	0.2	V	
	MMUN5232DW	V_{OL}	-	0.2	V	
	MMUN5233DW	V_{OL}	-	0.2	V	
	MMUN5234DW	V_{OL}	-	0.2	V	
	MMUN5235DW	V_{OL}	-	0.2	V	
	MMUN5238DW	V_{OL}	-	0.2	V	
	at $V_{CC} = 5\text{ V}$, $V_B = 3.5\text{ V}$, $R_L = 1\text{ K}\Omega$	MMUN5213DW	V_{OL}	-	0.2	V
	at $V_{CC} = 5\text{ V}$, $V_B = 5\text{ V}$, $R_L = 1\text{ K}\Omega$	MMUN5241DW	V_{OL}	-	0.2	V
Output Voltage (off) at $V_{CC} = 5\text{ V}$, $V_B = 0.5\text{ V}$, $R_L = 1\text{ K}\Omega$ at $V_{CC} = 5\text{ V}$, $V_B = 0.05\text{ V}$, $R_L = 1\text{ K}\Omega$ at $V_{CC} = 5\text{ V}$, $V_B = 0.25\text{ V}$, $R_L = 1\text{ K}\Omega$		V_{OH}	4.9	-	V	
	MMUN5230DW	V_{OH}	4.9	-	V	
	MMUN5215DW	V_{OH}	4.9	-	V	
	MMUN5216DW	V_{OH}	4.9	-	V	
	MMUN5233DW	V_{OH}	4.9	-	V	
	MMUN5238DW	V_{OH}	4.9	-	V	
Input Resistor	MMUN5211DW	R1	7	13	K Ω	
	MMUN5212DW	R1	15.4	28.6	K Ω	
	MMUN5213DW	R1	32.9	61.1	K Ω	
	MMUN5214DW	R1	7	13	K Ω	
	MMUN5215DW	R1	7	13	K Ω	
	MMUN5216DW	R1	3.3	6.1	K Ω	
	MMUN5230DW	R1	0.7	1.3	K Ω	
	MMUN5231DW	R1	1.5	2.9	K Ω	
	MMUN5232DW	R1	3.3	6.1	K Ω	
	MMUN5233DW	R1	3.3	6.1	K Ω	
	MMUN5234DW	R1	15.4	28.6	K Ω	
	MMUN5235DW	R1	1.54	2.86	K Ω	
	MMUN5238DW	R1	1.54	2.88	K Ω	
	MMUN5241DW	R1	70	130	K Ω	
Resistor Ratio	MMUN5211DW/MMUN5212DW/MMUN5213DW	R1/R2	0.8	1.2	-	
	MMUN5214DW	R1/R2	0.17	0.25	-	
	MMUN5215DW/MMUN5216DW/MMUN5238DW	R1/R2	-	-	-	
	MMUN5241DW	R1/R2	-	-	-	
	MMUN5230DW/MMUN5231DW/MMUN5232DW	R1/R2	0.8	1.2	-	
	MMUN5233DW	R1/R2	0.055	0.185	-	
	MMUN5234DW	R1/R2	0.38	0.56	-	
	MMUN5235DW	R1/R2	0.038	0.056	-	

TYPICAL ELECTRICAL CHARACTERISTICS – MMUN5211DW

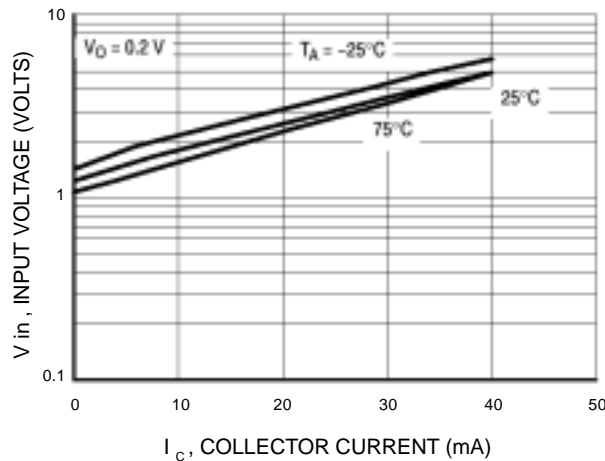
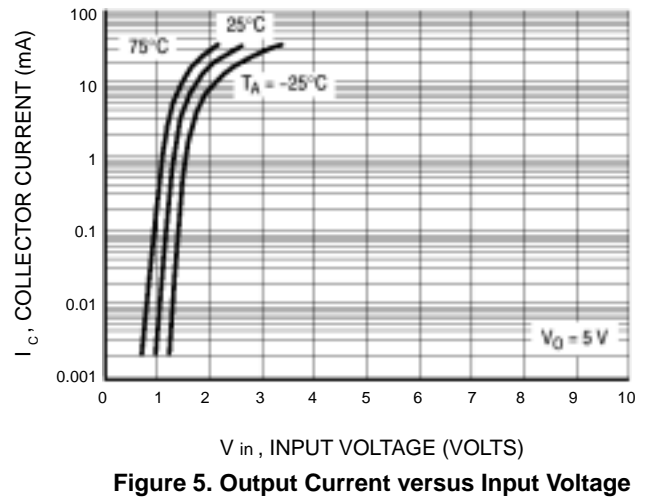
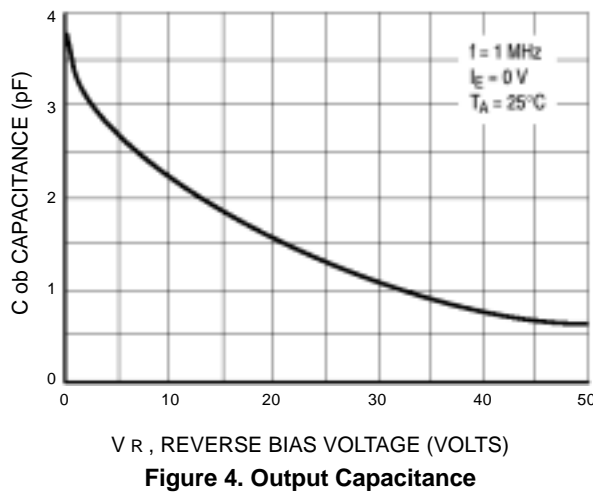
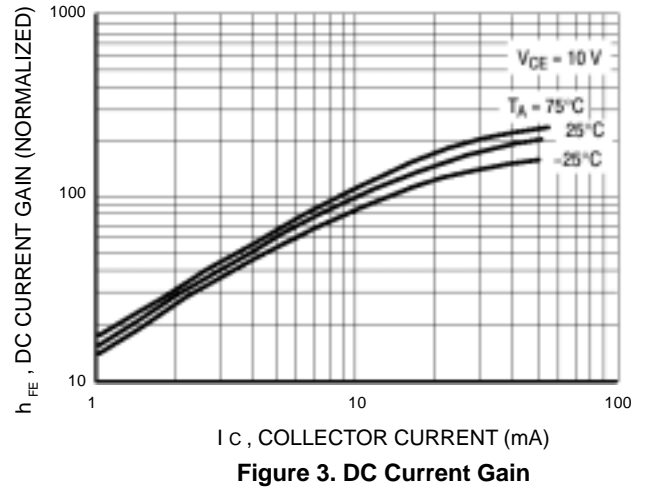
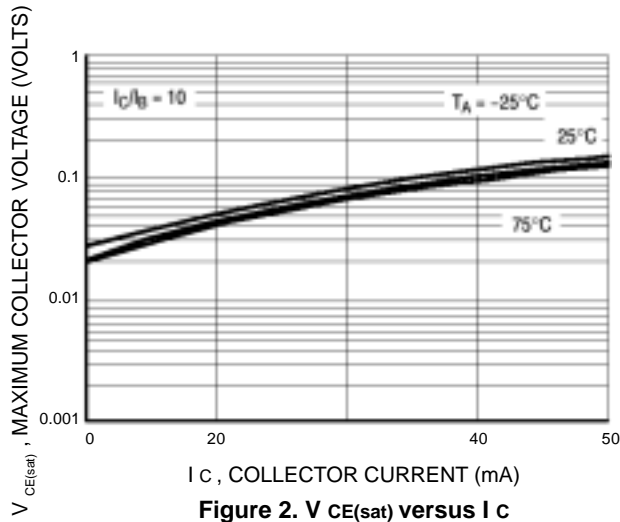



SOT-363 Package Outline Dimensions

