

## STRADA-SQ-VSM

IESNA Type V (square) beam for wide areas lighting such as car parks. Version with location pins.

### SPECIFICATION:

Dimensions	25.0 x 25.0 mm
Height	6.8 mm
Fastening	glue, pin, screw
ROHS compliant	yes ⓘ



### MATERIALS:

Component	Type	Material	Colour	Finish
STRADA-SQ-VSM	Single lens	PMMA	clear	

### ORDERING INFORMATION:

Component	Qty in box	MOQ	MPQ	Box weight (kg)
C12727_STRADA-SQ-VSM » Box size: 480 x 280 x 300 mm	2058	294	98	7.3

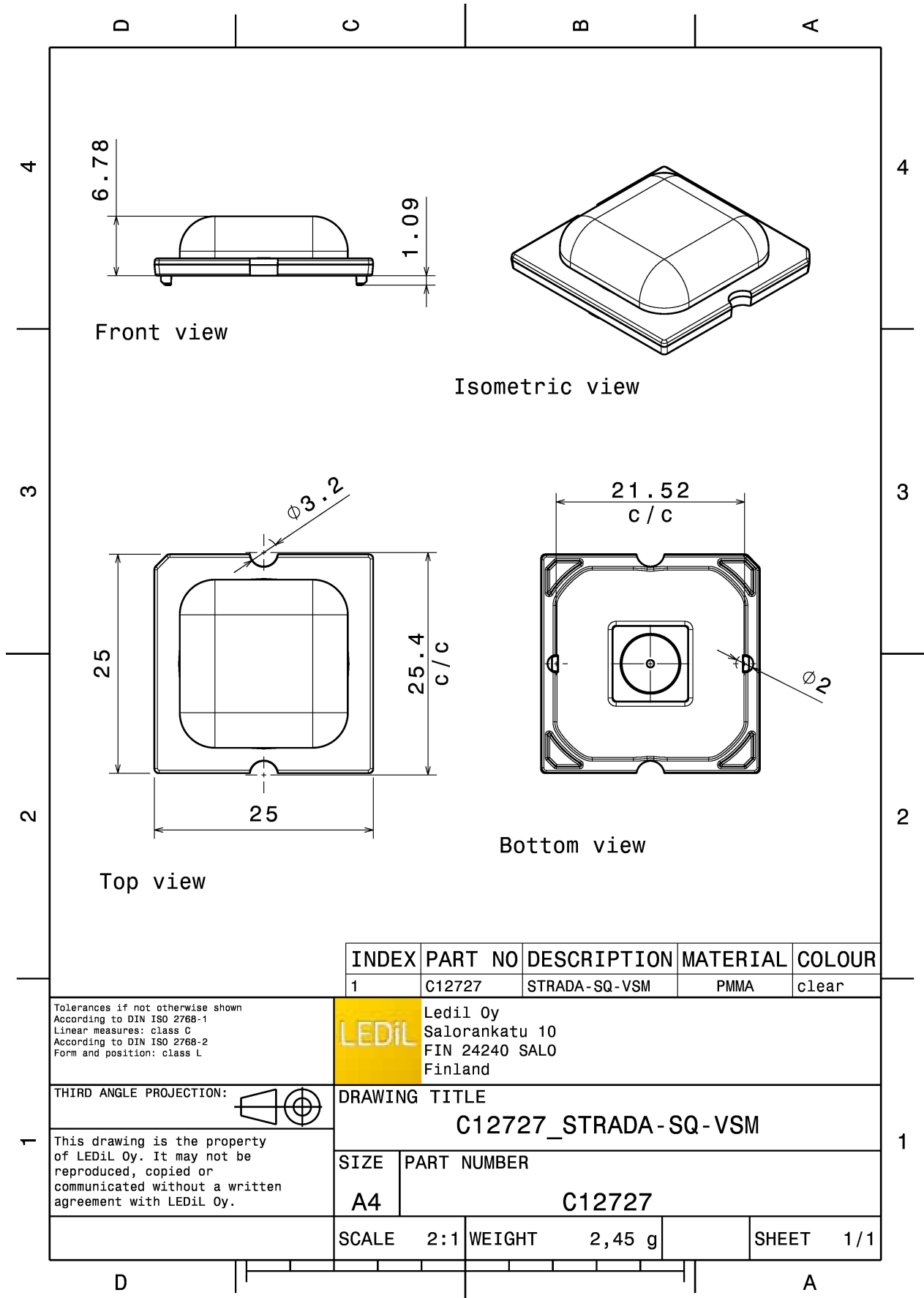

INDEX	PART NO	DESCRIPTION	MATERIAL	COLOUR
1	C12727	STRADA-SQ-VSM	PMMA	clear

Tolerances if not otherwise shown  
According to DIN ISO 2768-1  
Linear measures: class C  
According to DIN ISO 2768-2  
Form and position: class L

**LEDiL** Ledil Oy  
Salorankatu 10  
FIN 24240 SALO  
Finland

THIRD ANGLE PROJECTION:

DRAWING TITLE  
**C12727\_STRADA-SQ-VSM**

This drawing is the property of LEDiL Oy. It may not be reproduced, copied or communicated without a written agreement with LEDiL Oy.

SIZE	PART NUMBER
A4	C12727

SCALE	2:1	WEIGHT	2,45 g	SHEET	1/1
-------	-----	--------	--------	-------	-----

See also our general installation guide: [www.ledil.com/installation\\_guide](http://www.ledil.com/installation_guide)

#### OPTICAL RESULTS (MEASURED):

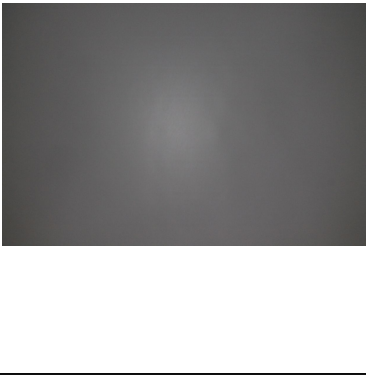
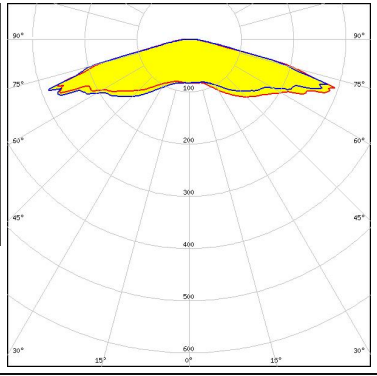
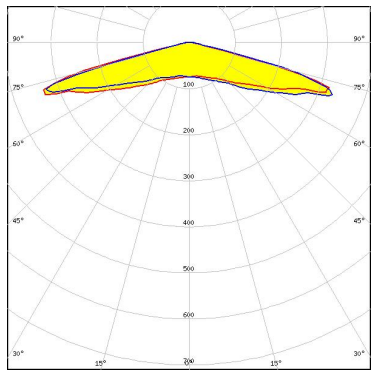
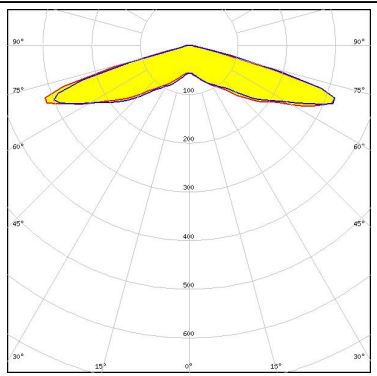
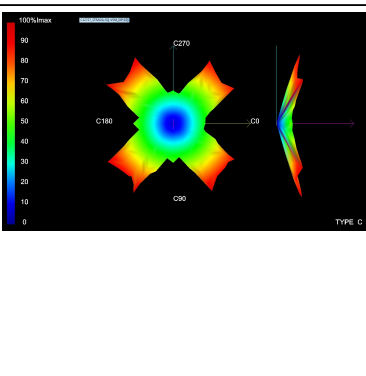
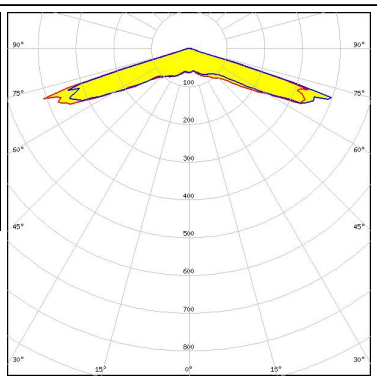
<p><b>CREE</b> LEDs</p> <p>LED XHP50            FWHM / FWTM 154.0° / 171.0°            Efficiency 94 %            Peak intensity 0.3 cd/lm            LEDs/each optic 1            Light colour White            Required components:</p>		
<p><b>CREE</b> LEDs</p> <p>LED XM-L            FWHM / FWTM 154.0°            Efficiency 93 %            Peak intensity 0.2 cd/lm            LEDs/each optic 1            Light colour White            Required components:</p>		
<p><b>CREE</b> LEDs</p> <p>LED XM-L2            FWHM / FWTM 155.0° / 177.0°            Efficiency 94 %            Peak intensity 0.4 cd/lm            LEDs/each optic 1            Light colour White            Required components:</p>		
<p><b>CREE</b> LEDs</p> <p>LED XP-E2            FWHM / FWTM 149.0° / 151.0°            Efficiency 94 %            Peak intensity 0.8 cd/lm            LEDs/each optic 1            Light colour White            Required components:</p>		

#### OPTICAL RESULTS (MEASURED):



LED XP-G2  
 FWHM / FWTM 149.0° / 153.0°  
 Efficiency 94 %  
 Peak intensity 0.7 cd/lm  
 LEDs/each optic 1  
 Light colour White  
 Required components:

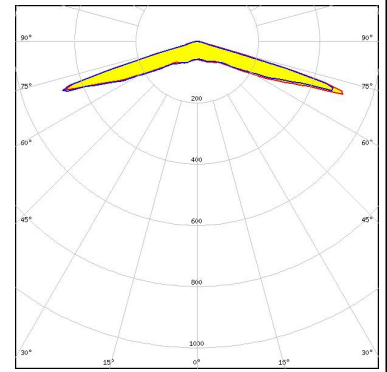

LED XP-L HD  
 FWHM / FWTM 152.0° / 162.0°  
 Efficiency 94 %  
 Peak intensity 0.5 cd/lm  
 LEDs/each optic 1  
 Light colour White  
 Required components:

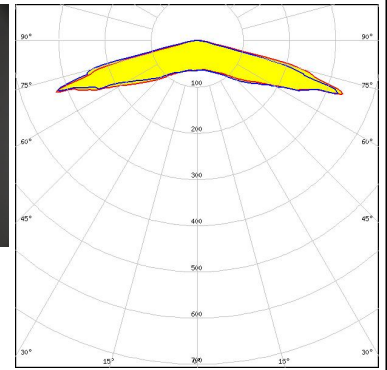
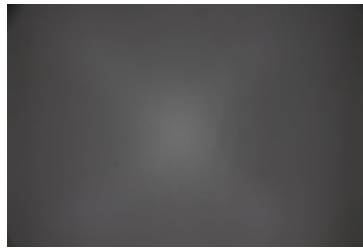

LED XP-L2  
 FWHM / FWTM 149.0° / 170.0°  
 Efficiency 94 %  
 Peak intensity 0.4 cd/lm  
 LEDs/each optic 1  
 Light colour White  
 Required components:

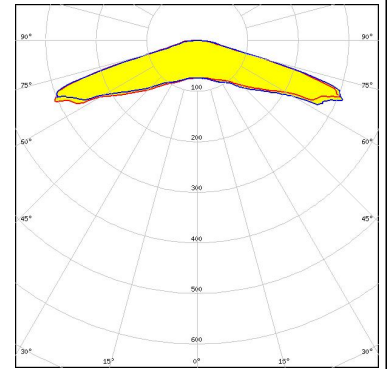

LED XT-E  
 FWHM / FWTM 151.0°  
 Efficiency 93 %  
 Peak intensity 0.2 cd/lm  
 LEDs/each optic 1  
 Light colour White  
 Required components:

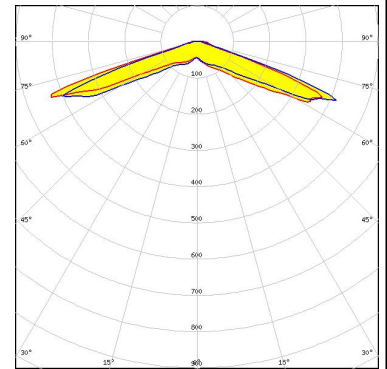

#### OPTICAL RESULTS (MEASURED):

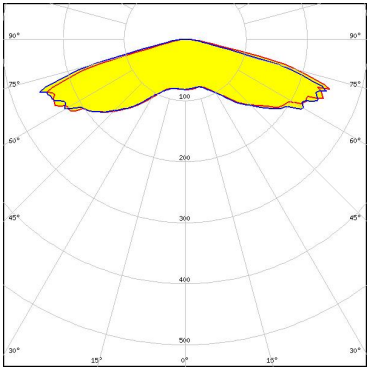
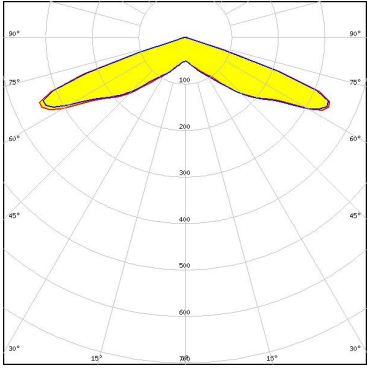
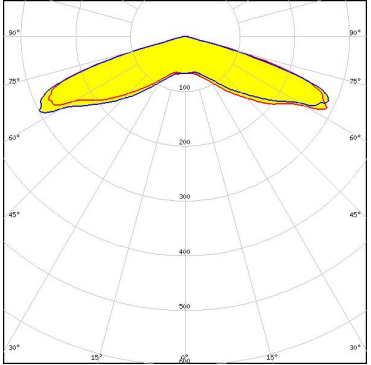
<p><b>LUMILEDS</b></p> <p>LED LUXEON M/MX</p> <p>FWHM / FWTM 154.0°</p> <p>Efficiency 93 %</p> <p>Peak intensity 0.3 cd/lm</p> <p>LEDs/each optic 1</p> <p>Light colour White</p> <p>Required components:</p>	
<p><b>LUMILEDS</b></p> <p>LED LUXEON MZ</p> <p>FWHM / FWTM 148.0° / 173.0°</p> <p>Efficiency 94 %</p> <p>Peak intensity 0.4 cd/lm</p> <p>LEDs/each optic 1</p> <p>Light colour White</p> <p>Required components:</p>	
<p><b>NICHIA</b></p> <p>LED NFMW48xA</p> <p>FWHM / FWTM 148.0° / 154.0°</p> <p>Efficiency 94 %</p> <p>Peak intensity 0.4 cd/lm</p> <p>LEDs/each optic 1</p> <p>Light colour White</p> <p>Required components:</p>	

#### OPTICAL RESULTS (SIMULATED):



LED J Series 5050 Round LES  
 FWHM / FWTM 148.0° / 158.0°  
 Efficiency 94 %  
 Peak intensity 0.4 cd/lm  
 LEDs/each optic 1  
 Light colour White  
 Required components:

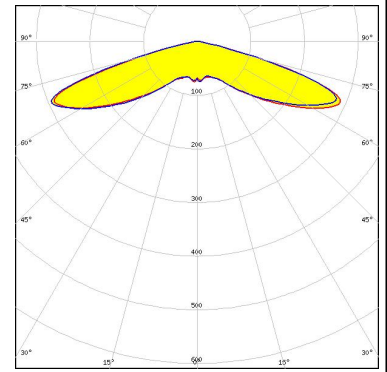

LED J Series 5050B 30V K Class  
 FWHM / FWTM 148.0° / 157.0°  
 Efficiency 71 %  
 Peak intensity 0.3 cd/lm  
 LEDs/each optic 1  
 Light colour White  
 Required components:

Protective plate, glass

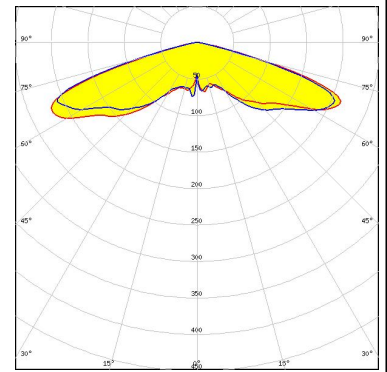

LED J Series 5050B 30V K Class  
 FWHM / FWTM 148.0° / 156.0°  
 Efficiency 89 %  
 Peak intensity 0.4 cd/lm  
 LEDs/each optic 1  
 Light colour White  
 Required components:

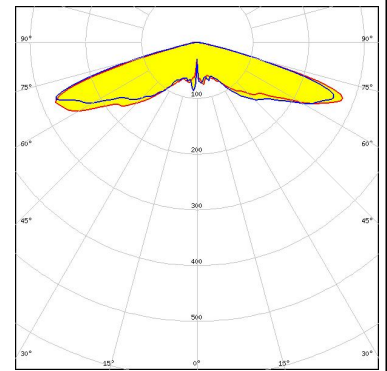

LED J Series 5050B 6V K Class  
 FWHM / FWTM 147.0° / 155.0°  
 Efficiency 95 %  
 Peak intensity 0.4 cd/lm  
 LEDs/each optic 1  
 Light colour White  
 Required components:

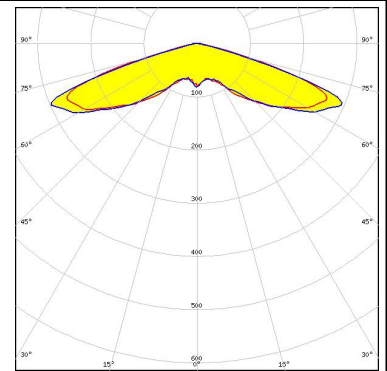

#### OPTICAL RESULTS (SIMULATED):



LED J Series 5050B 6V K Class  
 FWHM / FWTM 146.0° / 155.0°  
 Efficiency 77 %  
 Peak intensity 0.3 cd/lm  
 LEDs/each optic 1  
 Light colour White  
 Required components:

Protective plate, glass

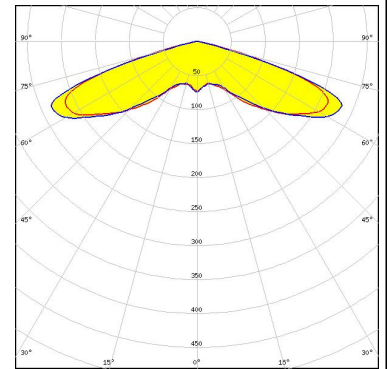

LED XHP50.3 HD  
 FWHM / FWTM 152.0° / 164.0°  
 Efficiency 91 %  
 Peak intensity 0.3 cd/lm  
 LEDs/each optic 1  
 Light colour White  
 Required components:

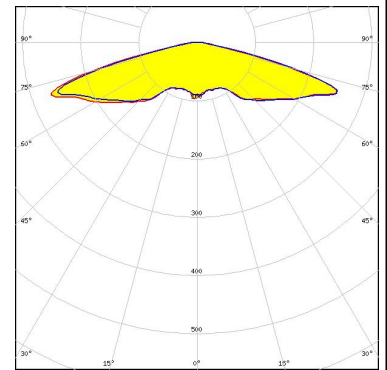

LED XP-G3  
 FWHM / FWTM 150.0° / 158.0°  
 Efficiency 93 %  
 Peak intensity 0.5 cd/lm  
 LEDs/each optic 1  
 Light colour White  
 Required components:

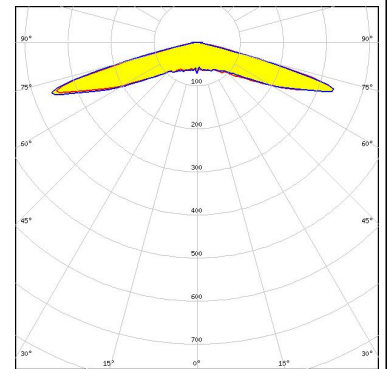

LED LUXEON 5050 Round LES  
 FWHM / FWTM 150.0° / 157.0°  
 Efficiency 94 %  
 Peak intensity 0.4 cd/lm  
 LEDs/each optic 1  
 Light colour White  
 Required components:

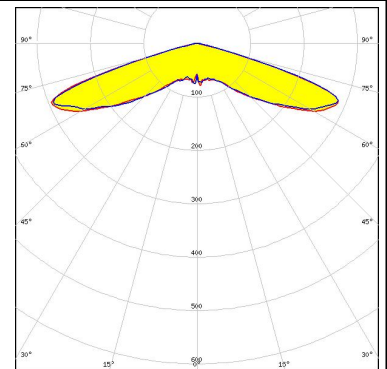

#### OPTICAL RESULTS (SIMULATED):

##### LUMILEDS

LED LUXEON 5050 Square LES  
 FWHM / FWTM 147.0° / 155.0°  
 Efficiency 76 %  
 Peak intensity 0.3 cd/lm  
 LEDs/each optic 1  
 Light colour White  
 Required components:

Protective plate, glass

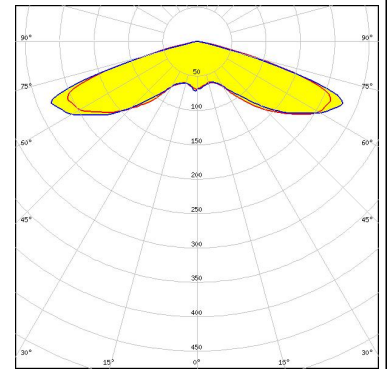

##### LUMILEDS

LED LUXEON 5050 Square LES  
 FWHM / FWTM 147.0° / 155.0°  
 Efficiency 94 %  
 Peak intensity 0.4 cd/lm  
 LEDs/each optic 1  
 Light colour White  
 Required components:

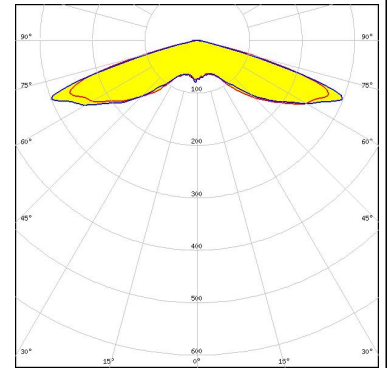

##### NICHIA

LED NVSW219F  
 FWHM / FWTM 150.0° / 150.0°  
 Efficiency 93 %  
 Peak intensity 0.5 cd/lm  
 LEDs/each optic 1  
 Light colour White  
 Required components:

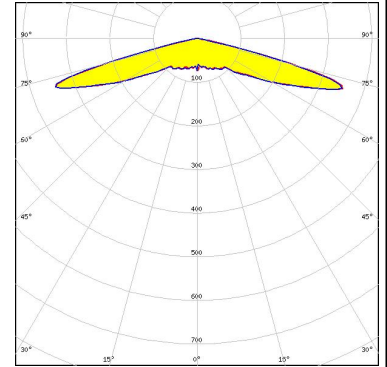

##### NICHIA

LED NVSW519A  
 FWHM / FWTM 154.0° / 160.0°  
 Efficiency 91 %  
 Peak intensity 0.4 cd/lm  
 LEDs/each optic 1  
 Light colour White  
 Required components:

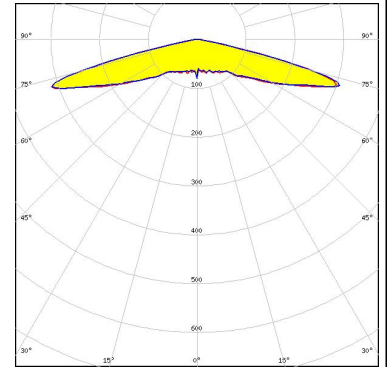



#### OPTICAL RESULTS (SIMULATED):

##### OSRAM

Opto Semiconductors

LED OSCONIQ P 7070  
 FWHM / FWTM 150.0° / 154.0°  
 Efficiency 90 %  
 Peak intensity 0.4 cd/lm  
 LEDs/each optic 1  
 Light colour White  
 Required components:

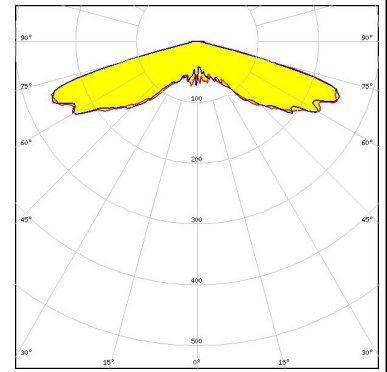

##### OSRAM

Opto Semiconductors

LED OSCONIQ S 5050  
 FWHM / FWTM 147.0° / 156.0°  
 Efficiency 77 %  
 Peak intensity 0.3 cd/lm  
 LEDs/each optic 1  
 Light colour White  
 Required components:

Protective plate, glass

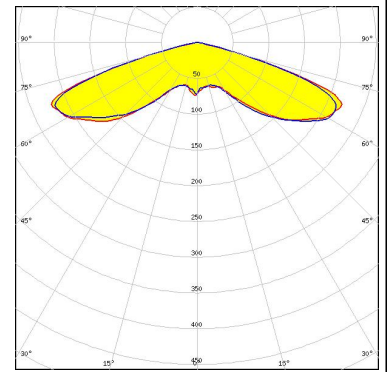

##### OSRAM

Opto Semiconductors

LED OSCONIQ S 5050  
 FWHM / FWTM 148.0° / 156.0°  
 Efficiency 95 %  
 Peak intensity 0.4 cd/lm  
 LEDs/each optic 1  
 Light colour White  
 Required components:

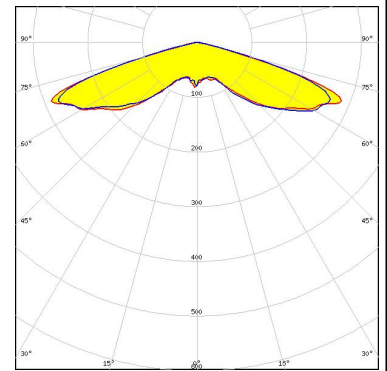

##### OSRAM

Opto Semiconductors

LED OSLOM Square CSSRM2/CSSRM3  
 FWHM / FWTM 144.0°  
 Efficiency 94 %  
 LEDs/each optic 1  
 Light colour White  
 Required components:

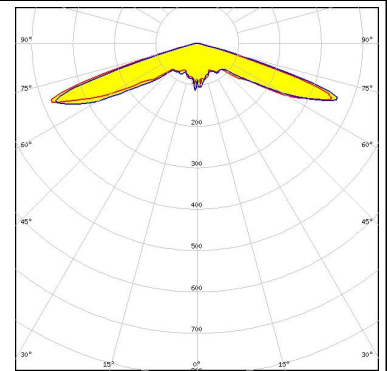

### OPTICAL RESULTS (SIMULATED):



### GENERAL INFORMATION:

NOTE: The typical beam angle will be changed by different color, chip size and chip position tolerance. The typical total beam angle is the full angle measured where the luminous intensity is half of the peak value.

### MATERIALS:

As part of our continuous research and improvement processes, and to ensure the best possible quality and availability of our products, LEDiL reserves the right to change material grades without notice.

### PRODUCT DATA USER AGREEMENT AND DISCLAIMER:

The measured data in the provided downloadable LEDiL Product Datasheets and Mechanical 2D-Drawings is rounded and provided as reference for planning. LEDiL Oy's optical specifications have been verified by conducting performance testing of the products in accordance with the company's quality system. The reported data are averaged results of multiple measurements with typical variation. LEDiL Oy reserves the right to without prior notification make changes and improvements to its products.

LEDiL Oy assumes neither warranty, nor guarantee nor any other liability of any kind for the contents and correctness of the provided data. The provided data has been generated with highest diligence but the provided data may in reality not represent the complete possible variation range of all intrinsic parameters. Therefore, in certain cases a deviation from the provided data could occur.

LEDiL Oy reserves the right to undertake technical changes of its products without further notification which could lead to changes in the provided data. LEDiL Oy assumes no liability of any kind for the possible deviation from any provided data or any other damage resulting from the usage of the provided data.

The user agrees to this disclaimer and user agreement with the download or usage of the provided files.

#### LEDiL Oy

Joensuunkatu 13  
FI-24240 SALO  
Finland

#### LEDiL Inc.

228 West Page Street  
Suite D  
Sycamore IL 60178  
USA

#### Ledil Optics Technology (Shenzhen) Co., Ltd.

# 405 , Block B  
Casic Motor Building  
Shenzhen 518057  
P.R.CHINA

#### Local sales and technical support

[www.ledil.com/  
where\\_to\\_buy](http://www.ledil.com/where_to_buy)

#### Shipping locations

Salo, Finland  
Hong Kong, China

#### Distribution Partners

[www.ledil.com/  
where\\_to\\_buy](http://www.ledil.com/where_to_buy)