

Features

- Inventronics patented metal case (Patent NO.: 201530552642.8)
- High Efficiency (Up to 92%)
- Full Power at Wide Output Current Range (Constant Power)
- Adjustable Output Current (AOC) with Potentiometer (ST models)
- Adjustable Output Current (AOC) with Programmability (DT models)
- 0-10V/PWM Dimmable (Only DT models)
- Input Surge Protection: 4kV line-line, 4kV line-earth
- All-Around Protection: OVP, SCP, OTP
- Waterproof (IP65) and UL Dry / Damp / Wet Location
- Class 2 & SELV Output
- TYPE HL, for use in a Class I, Division 2 hazardous (Classified) location
- 5 Years Warranty



Description

The EUR-096SxxxDT(ST) series is a 96W, constant-current, AOC LED driver that operates from 90-305 Vac input with excellent power factor. It is designed in round shape and specially created for bay lighting. The high efficiency of these drivers and compact metal case enables them to run cooler, significantly improving reliability and extending product life. To ensure trouble-free operation, protection is provided against input surge, output over voltage, short circuit, and over temperature.

Models

Adjustable Output Current Range	Full-Power Current Range (1)	Default Output Current	Input Voltage Range (2)	Output Voltage Range	Max. Output Power	Typical Efficiency (3)	Power Factor		Model Number
							120Vac	220Vac	
140-2100mA	1400-2100mA	2000mA	90~305 Vac/ 127~300 Vdc	24 ~ 69Vdc	96 W	91.5%	0.99	0.96	EUR-096S210DT ⁽⁴⁾
1400-2100mA	1400-2100mA	2000mA	90~305 Vac/ 127~300 Vdc	24 ~ 69Vdc	96 W	91.5%	0.99	0.96	EUR-096S210ST ⁽⁴⁾
175-2150mA	1750-2150mA	2000mA	90~305 Vac/ 127~300 Vdc	24 ~ 55Vdc	96 W	92.0%	0.99	0.96	EUR-096S215DT ⁽⁵⁾
245-3500mA	2450-3500mA	2700mA	90~305 Vac/ 127~300 Vdc	14 ~ 39Vdc	96 W	91.0%	0.99	0.96	EUR-096S350DT ⁽⁵⁾
2450-3500mA	2450-3500mA	2700mA	90~305 Vac/ 127~300 Vdc	14 ~ 39Vdc	96 W	91.0%	0.99	0.96	EUR-096S350ST ⁽⁵⁾

- Notes:** (1) Output current range with constant power at 96W
 (2) Certified input voltage range: UL, FCC 100-277Vac or 127-300Vdc; otherwise 100-240Vac or 127-250Vdc (except KS).
 (3) Measured at 100%load and 220Vac input (see below "General Specifications" for details).
 (4) SELV Output.
 (5) Class 2 & SELV Output.

I-V Operation Area

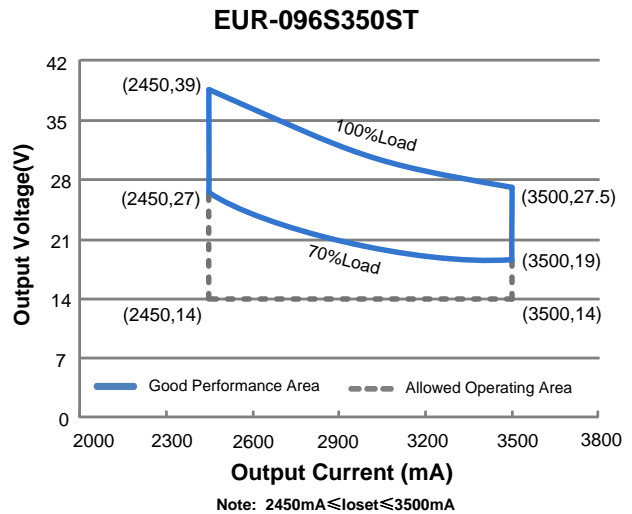
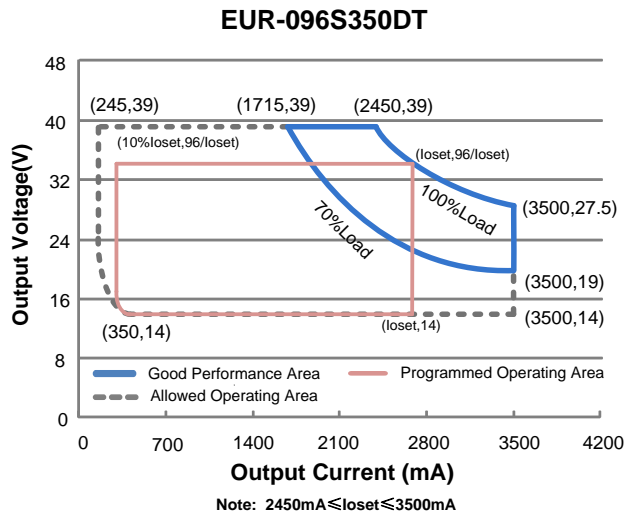
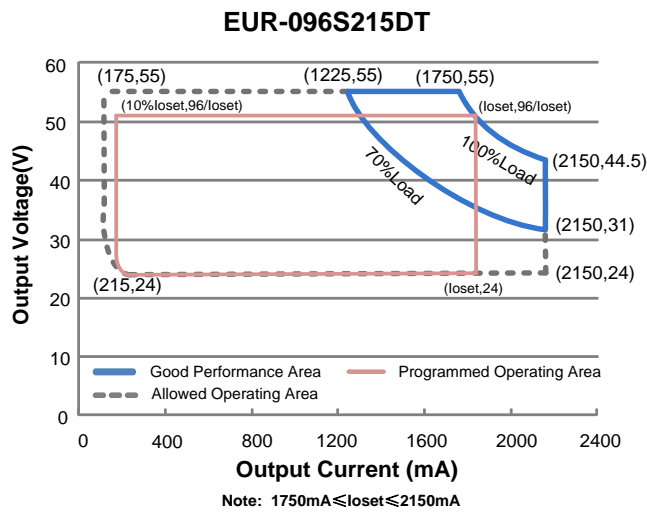
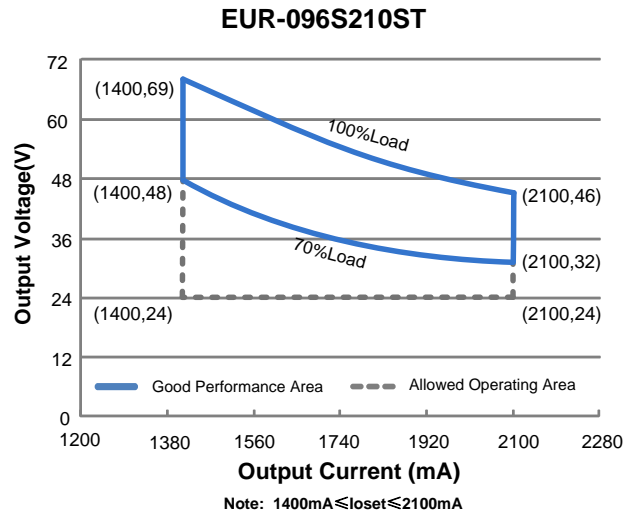
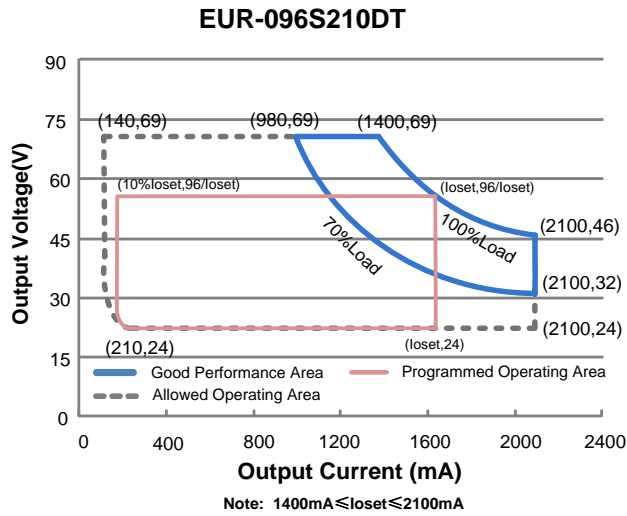

Input Specifications

Parameter	Min.	Typ.	Max.	Notes
Input Voltage	90 Vac	-	305 Vac	127~30 Vdc
Input Frequency	47 Hz	-	63 Hz	
Leakage Current	-	-	0.75 MIU	UL8750; 277Vac/ 60Hz
	-	-	0.70 mA	IEC60598-1; 240Vac/ 60Hz
Input AC Current	-	-	1.32 A	Measured at 100%load and 100Vac input.
	-	-	0.60 A	Measured at 100%load and 220Vac input.
Inrush Current(I ² t)	-	-	1.60 A ² s	At 220Vac input, 25°C cold start, duration=760 μs, 10%Ipk-10%Ipk. See Inrush Current Waveform for the details.
PF	0.90	-	-	At 100-277Vac, 50-60Hz, 70%-100% Load (67-96W)
THD	-	-	20%	
THD	-	-	10%	At 220-240Vac, 50-60Hz, 75%-100% Load (72-96W)

Output Specifications

Parameter	Min.	Typ.	Max.	Notes
Output Current Tolerance	-5%loset	-	5%loset	100%load
Output Current Setting(loset) Range		-		
EUR-096S210DT	140 mA	-	2100 mA	
EUR-096S210ST	1400 mA	-	2100 mA	
EUR-096S215DT	175 mA	-	2150 mA	
EUR-096S350DT	245 mA	-	3500 mA	
EUR-096S350ST	2450 mA	-	3500 mA	
Output Current Setting Range with Constant Power		-		
EUR-096S210DT	1400 mA	-	2100 mA	
EUR-096S210ST	1400 mA	-	2100 mA	
EUR-096S215DT	1750 mA	-	2150 mA	
EUR-096S350DT	2450 mA	-	3500 mA	
EUR-096S350ST	2450 mA	-	3500 mA	
Total Output Current Ripple (pk-pk)	-	5%lomax	10%lomax	100%load. 20 MHz BW
Output Current Ripple at < 200 Hz (pk-pk)	-	2%lomax	-	100%load
Startup Overshoot Current	-	-	10%lomax	100%load
No Load Output Voltage		-		
EUR-096S210DT/ST	-	-	90 V	
EUR-096S215DT	-	-	59 V	
EUR-096S350DT/ST	-	-	50 V	
Line Regulation	-	-	±0.5%	100%load

Output Specifications (Continued)

Parameter	Min.	Typ.	Max.	Notes
Load Regulation	-	-	±1.5%	
Turn-on Delay Time	-	-	1.0 s	Measured at 120Vac input, 70%-100% Load
	-	-	0.5 s	Measured at 220Vac input, 70%-100% Load
Temperature Coefficient of I _o set	-	0.03%/°C	-	Case temperature = 0°C ~T _c max
12V Auxiliary Output Voltage	10.8 V	12 V	13.2 V	
12V Auxiliary Output Source Current	0 mA	-	20 mA	Return terminal is "Dim-"

Note: All specifications are typical at 25°C unless otherwise stated.

General Specifications

Parameter	Min.	Typ.	Max.	Notes		
Efficiency at 120 Vac input: EUR-096S210DT/ST I _o =1400 mA I _o =2100 mA EUR-096S215DT I _o =1750 mA I _o =2150 mA EUR-096S350DT/ST I _o =2450 mA I _o =3500 mA	86.5% 87.0%	89.5% 90.0%	- -	Measured at 100%load and steady-state temperature in 25°C ambient; (Efficiency will be about 2.0% lower if measured immediately after startup.)		
Efficiency at 220 Vac input: EUR-096S210DT/ST I _o =1400 mA I _o =2100 mA EUR-096S215DT I _o =1750 mA I _o =2150 mA EUR-096S350DT/ST I _o =2450 mA I _o =3500 mA	89.5% 89.5%	91.5% 91.5%	- -			
Efficiency at 277 Vac input: EUR-096S210DT/ST I _o =1400 mA I _o =2100 mA EUR-096S215DT I _o =1750 mA I _o =2150 mA EUR-096S350DT/ST I _o =2450 mA I _o =3500 mA	90.0% 90.0%	92.0% 92.0%	- -		Measured at 100%load and steady-state temperature in 25°C ambient; (Efficiency will be about 2.0% lower if measured immediately after startup.)	
MTBF	-	354,000 Hours	-			Measured at 220Vac input, 80%Load and 25°C ambient temperature (MIL-HDBK-217F)
Lifetime	-	85,000 Hours	-			Measured at 220Vac input, 80%Load and 70°C case temperature; See lifetime vs. T _c curve for the details

General Specifications (Continued)

Parameter	Min.	Typ.	Max.	Notes
Operating Case Temperature for Safety Tc_s	-40°C	-	+90°C	
Operating Case Temperature for Warranty Tc_w	-40°C	-	+75°C	Case temperature for 5 years warranty
Storage Temperature	-40°C	-	+85°C	Humidity: 5%RH to 100%RH
Dimensions Inches (∅ x H) Millimeters (∅ x H)	∅5.12 x 2.76 ∅130 x 70			
Net Weight	-	1150 g	-	

Note: All specifications are typical at 25°C unless otherwise stated.

Dimming Specifications

Parameter	Min.	Typ.	Max.	Notes	
Absolute Maximum Voltage on the Vdim (+) Pin	-20 V	-	20 V		
Source Current on Vdim (+)Pin	200 uA	300 uA	450 uA	Vdim(+) = 0 V	
Dimming Output Range	EUR-096S210DT EUR-096S215DT EUR-096S350DT	10%loset	-	loset	1400 mA ≤ loset ≤ 2100 mA 1750 mA ≤ loset ≤ 2150 mA 2450 mA ≤ loset ≤ 3500 mA
	EUR-096S210DT EUR-096S215DT EUR-096S350DT	140 mA 175 mA 245 mA	-	loset	140 mA ≤ loset < 1400 mA 175 mA ≤ loset < 1750 mA 245 mA ≤ loset < 2450 mA
	Recommended Dimming Input Range	0 V	-	10 V	Default 0-10V dimming mode.
PWM_in High Level	3 V	-	10 V	Dimming mode set to PWM in PC interface.	
PWM_in Low Level	-0.3 V	-	0.6 V		
PWM_in Frequency Range	200 Hz	-	2 KHz		
PWM_in Duty Cycle	1%	-	99%		

Safety & EMC Compliance

Safety Category	Standard
UL/CUL	UL 8750, UL 1310, CAN/CSA-C22.2 No. 250.13, CAN/CSA-C22.2 No. 223-M91
CE	EN 61347-1, EN61347-2-13
KS	KS C 7655
EMI Standards	Notes
EN 55015 ⁽¹⁾	Conducted emission Test &Radiated emission Test

Safety & EMC Compliance (Continued)

EMI Standards	Notes
EN 61000-3-2	Harmonic current emissions
EN 61000-3-3	Voltage fluctuations & flicker
FCC Part 15 ⁽¹⁾	ANSI C63.4 Class B
	This device complies with Part 15 of the FCC Rules. Operation is subject to the following two conditions: [1] this device may not cause harmful interference, and [2] this device must accept any interference received, including interference that may cause undesired Operation.
EMS Standards	Notes
EN 61000-4-2	Electrostatic Discharge (ESD): 8 kV air discharge, 4 kV contact discharge
EN 61000-4-3	Radio-Frequency Electromagnetic Field Susceptibility Test-RS
EN 61000-4-4	Electrical Fast Transient / Burst-EFT
EN 61000-4-5	Surge Immunity Test: AC Power Line: line to line 4 kV, line to earth 4kV
EN 61000-4-6	Conducted Radio Frequency Disturbances Test-CS
EN 61000-4-8	Power Frequency Magnetic Field Test
EN 61000-4-11	Voltage Dips
EN 61547	Electromagnetic Immunity Requirements Applies To Lighting Equipment

Note: (1) This LED driver meets the EMI specifications above, but EMI performance of a luminaire that contains it depends also on the other devices connected to the driver and on the fixture itself.

Lifetime vs. Case Temperature

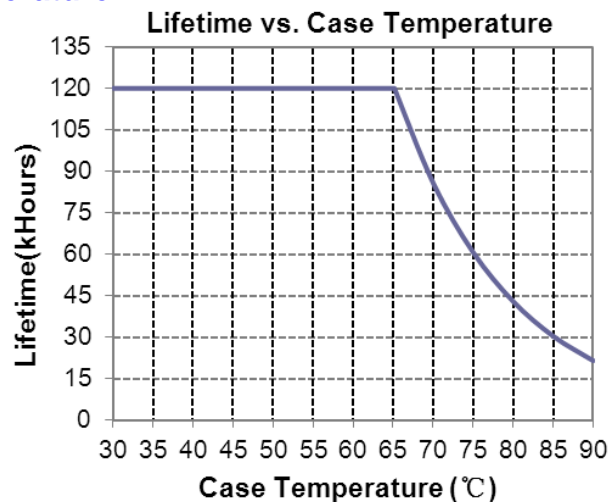

Inrush Current Waveform

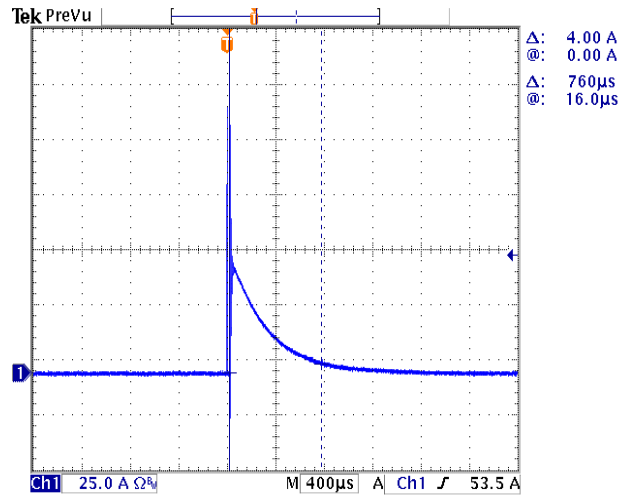

Efficiency vs. Load

EUR-096S2 10DT/ST (Io=1400mA)
Efficiency vs. Output Voltage

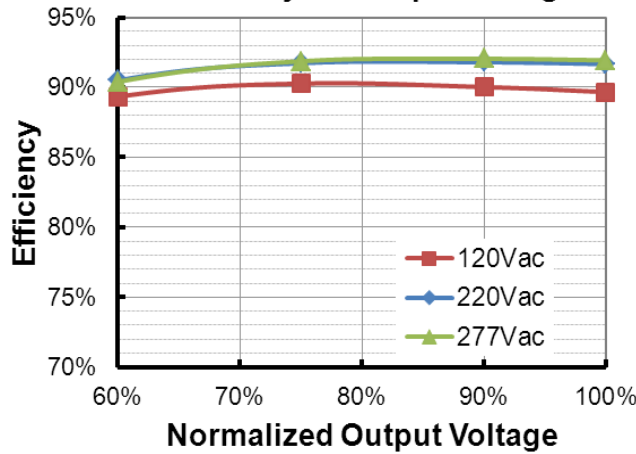

EUR-096S2 10DT/ST (Io=2100mA)
Efficiency vs. Output Voltage

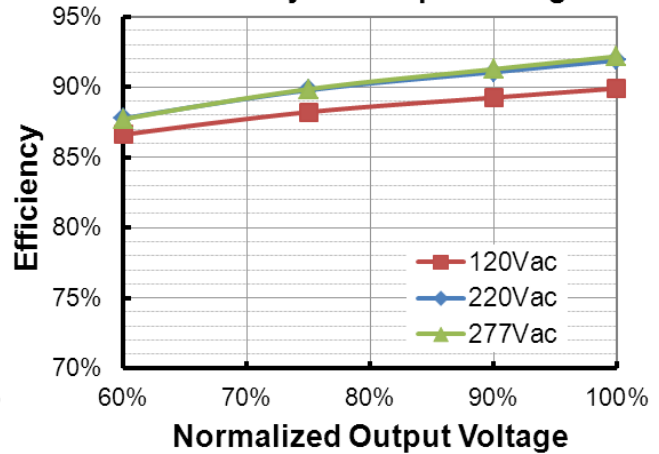

EUR-096S2 15DT (Io=1750mA)
Efficiency vs. Output Voltage

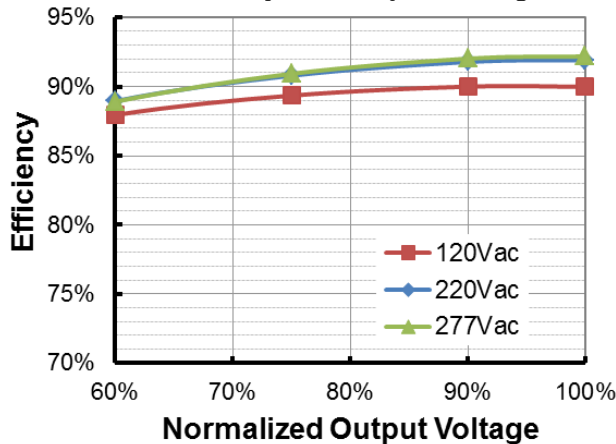

EUR-096S2 15DT (Io=2150mA)
Efficiency vs. Output Voltage

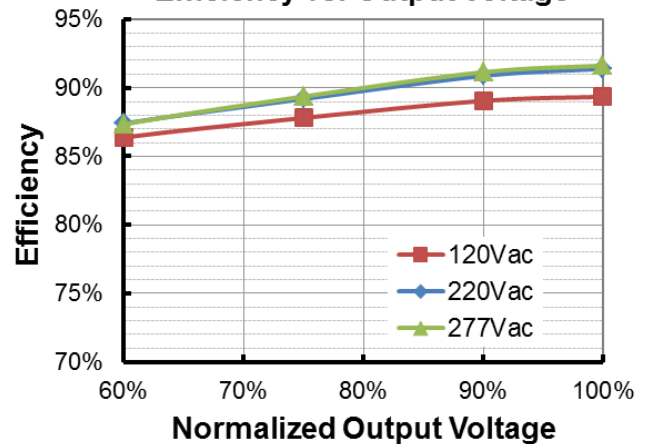

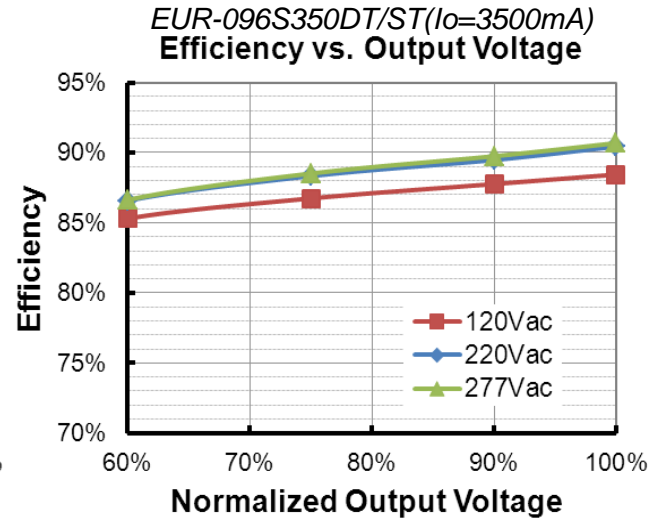
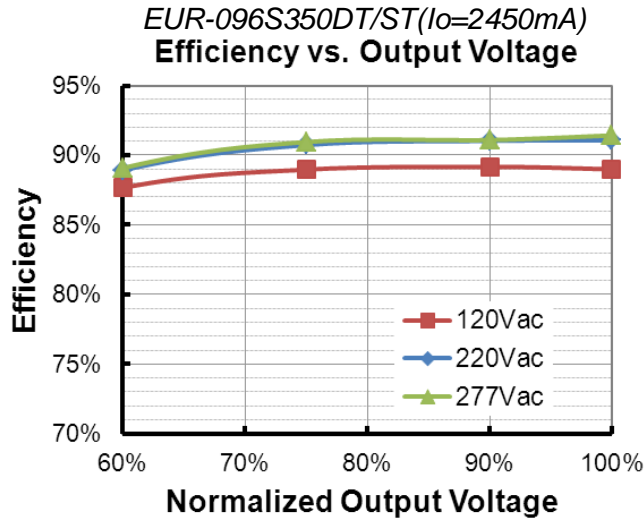

Power Factor

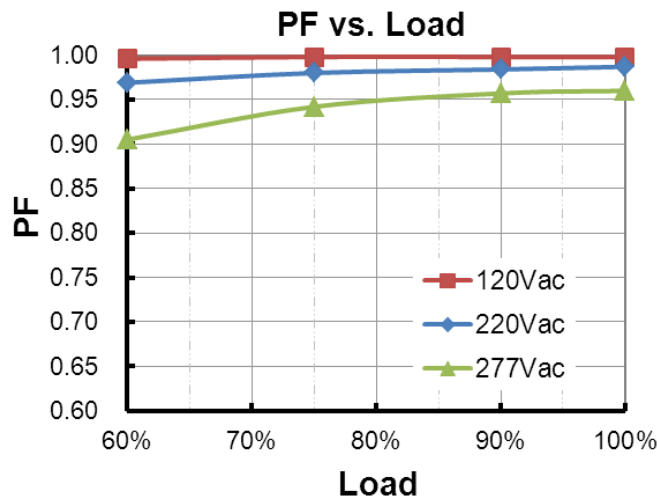

Total Harmonic Distortion

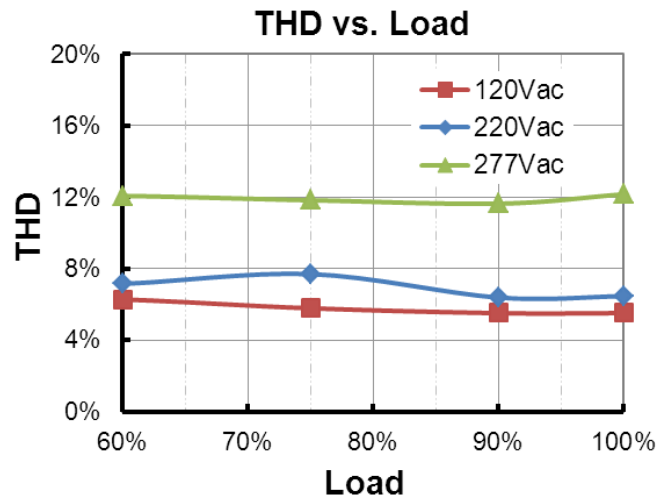

Protection Functions

Parameter	Notes
Over Temperature Protection	Decreases output current, returning to normal after over temperature is removed.
Short Circuit Protection	Auto Recovery. No damage will occur when any output is short circuited. The output shall return to normal when the fault condition is removed.
Over Voltage Protection	Limits output voltage at no load and in case the normal voltage limit fails.

Dimming

● 0-10V Dimming

The recommended implementation of the dimming control is provided below.

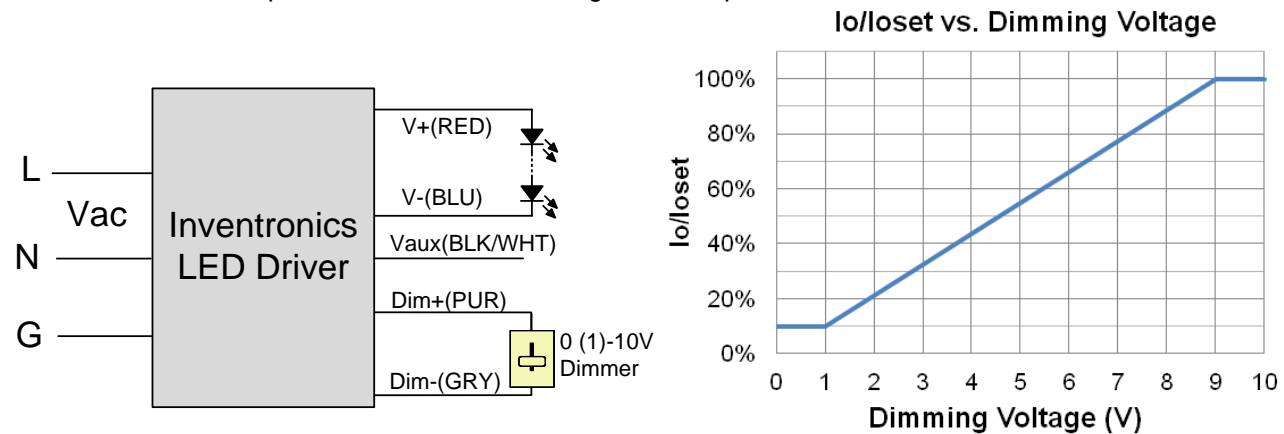

Implementation 1: DC Input

Notes:

1. The dimmer can also be replaced by an active 0-10V voltage source signal or passive components like resistors and zener.
2. Do NOT connect Dim- to the output V- or V+, otherwise the driver will not work properly.
3. If 0-10V dimming is not used, Dim + should be open.

● PWM Dimming

The recommended implementation of the dimming control is provided below.

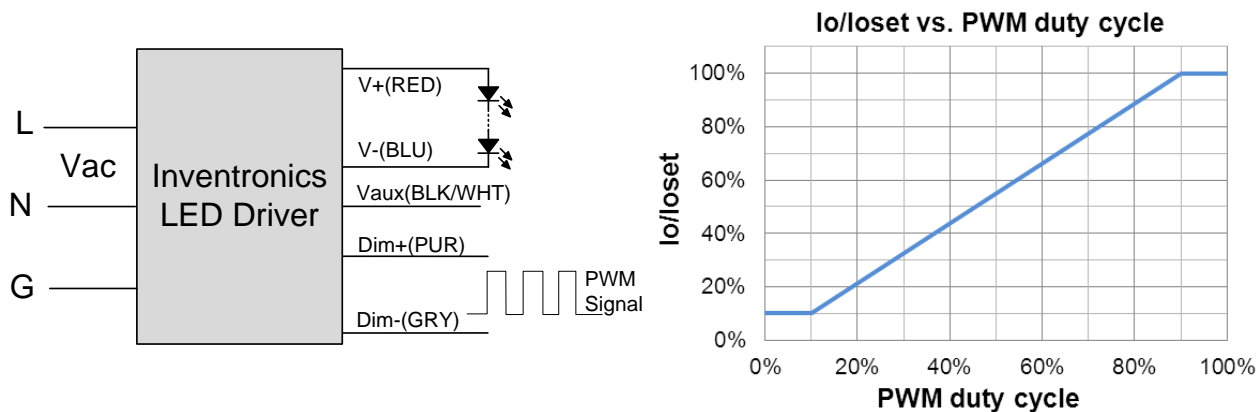

Implementation 2: Positive logic

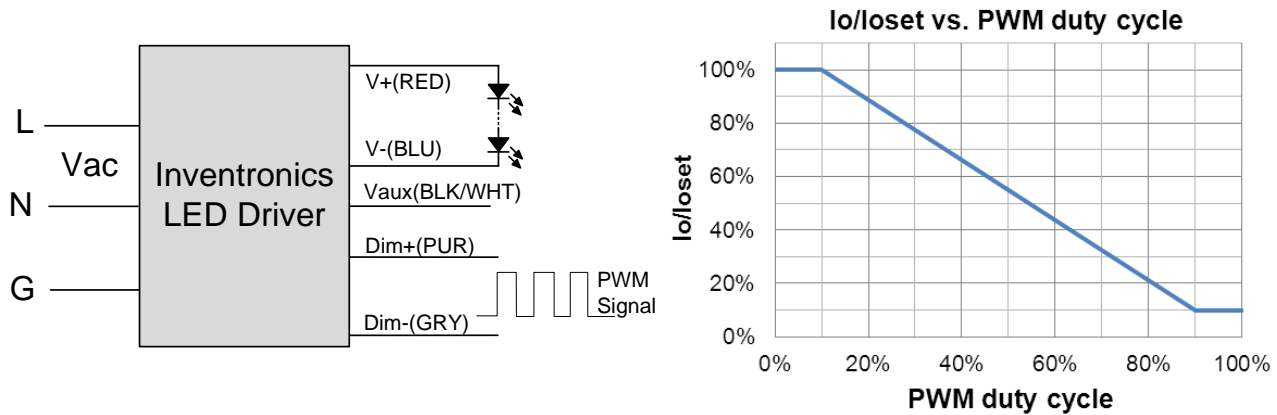

Implementation 3: Negative logic

Notes:

1. Do NOT connect Dim- to the output V- or V+, otherwise the driver will not work properly.
2. If PWM dimming is not used, Dim + should be open.
3. When PWM negative logic dimming mode and Dim+ is open, the driver will output minimum current.



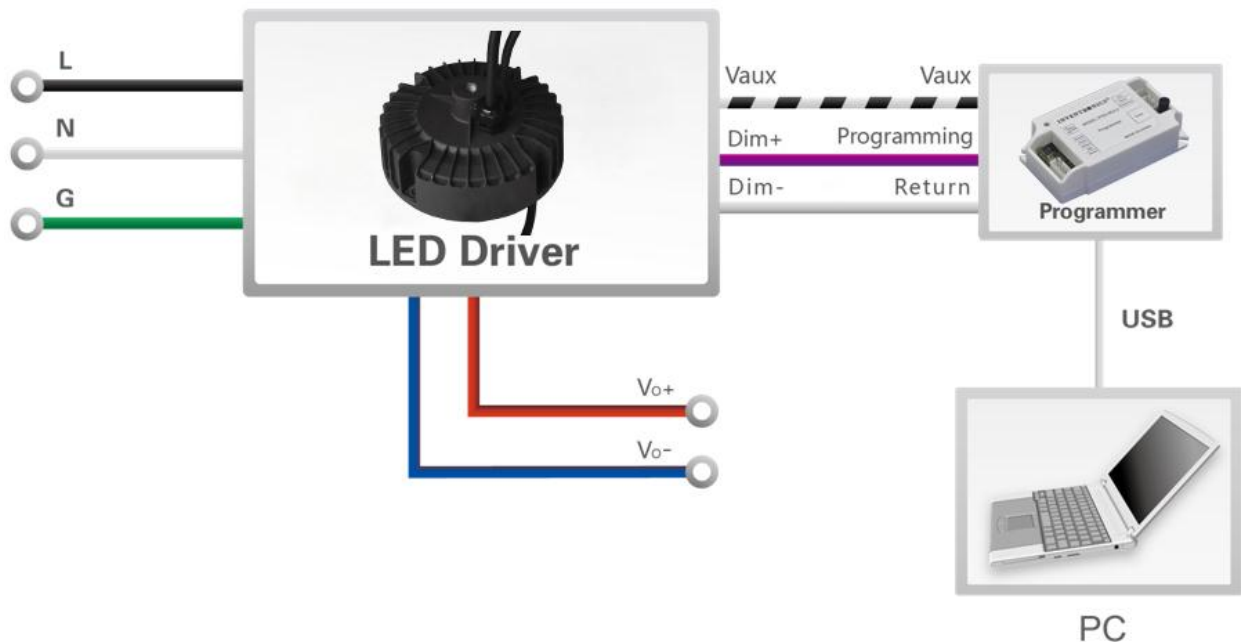

Programming Connection Diagram (Only DT models)

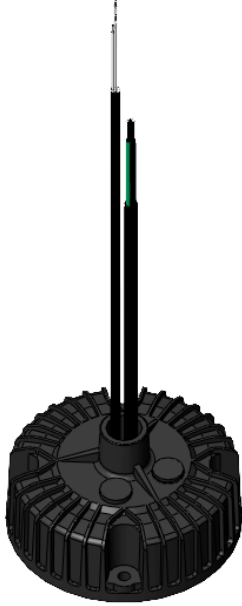

Note: The driver does not need to be powered on during the programming process.

- Please refer to [PRG-MUL2](#) Multi-Programmer datasheet for details.

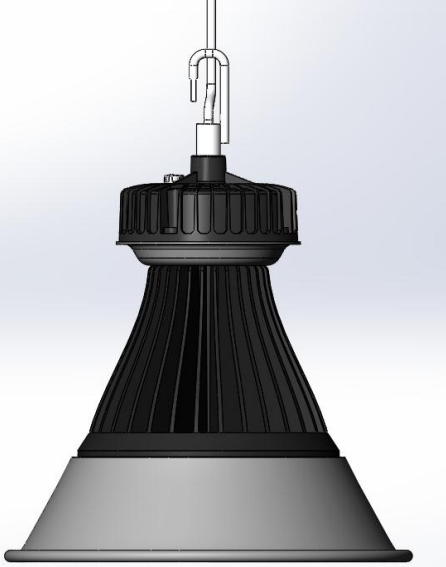
Installations

Part Number Suffix	-0000	-0001
Product Type	Center Wire Feed	Outside Wire Feed
Product Appearance		
Installation Type		

Caution:

1. Complete visual inspection prior to assembly to insure driver is received in proper condition.
2. Thread length for mounting accessory (hook, ring, etc.) should be 16-22mm. After mounting accessory (hook, ring, etc.) is installed an M4 set screw should be secured in the open location on the driver collar.
3. Maximum weight of combined luminaire/driver assembly should not exceed 11Kg.

Mechanical Outline

EUR-096SxxxDT-0000

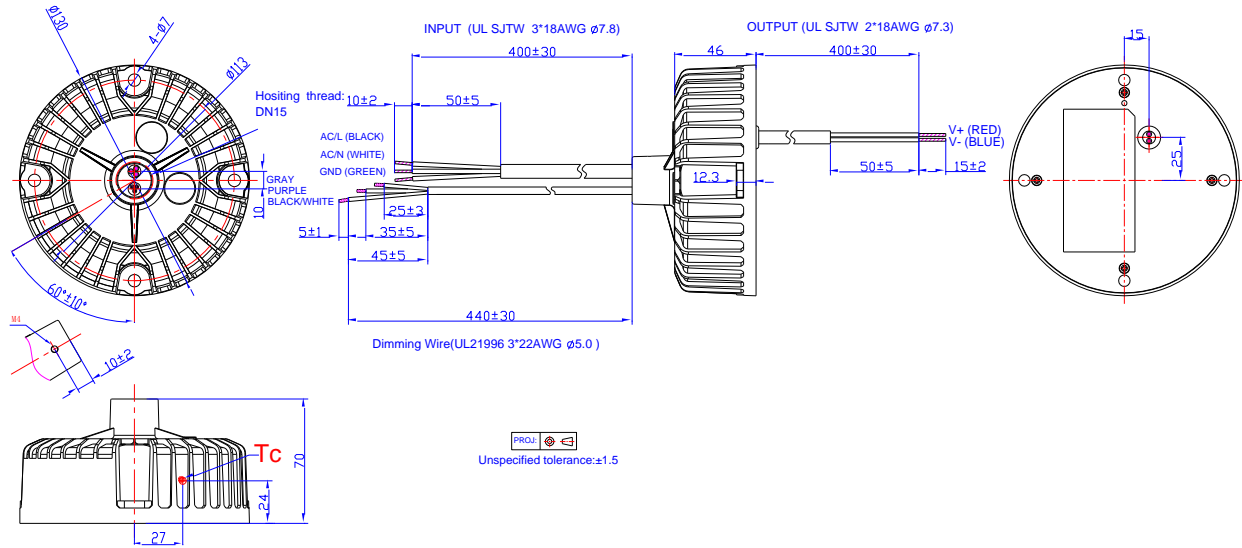

EUR-096SxxxST-0000

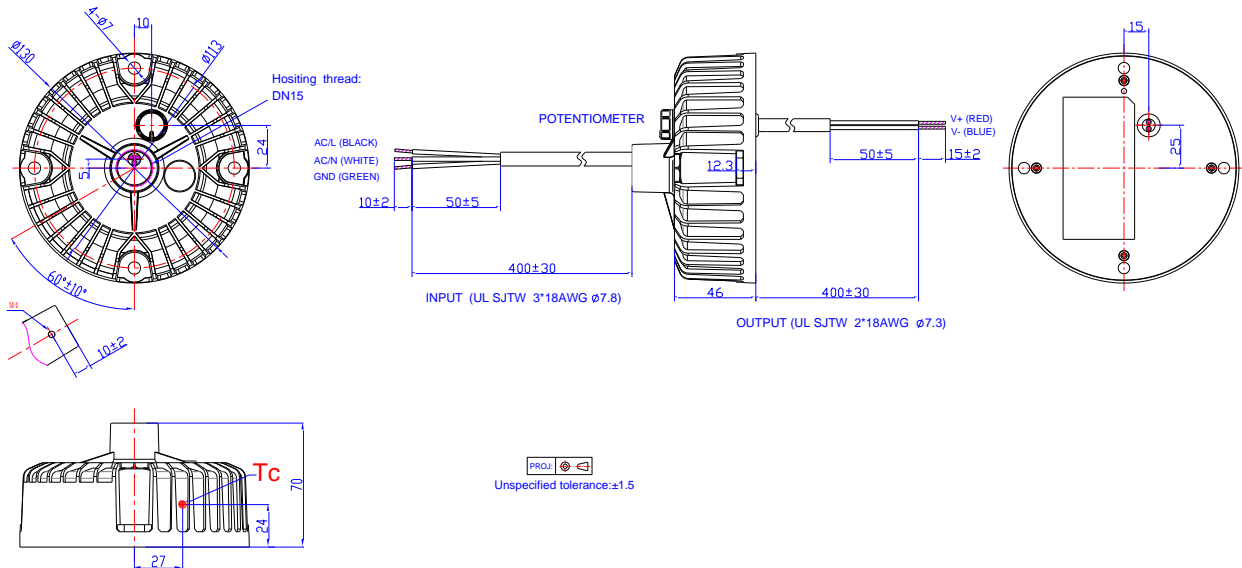

EUR-096SxxxDT-0001

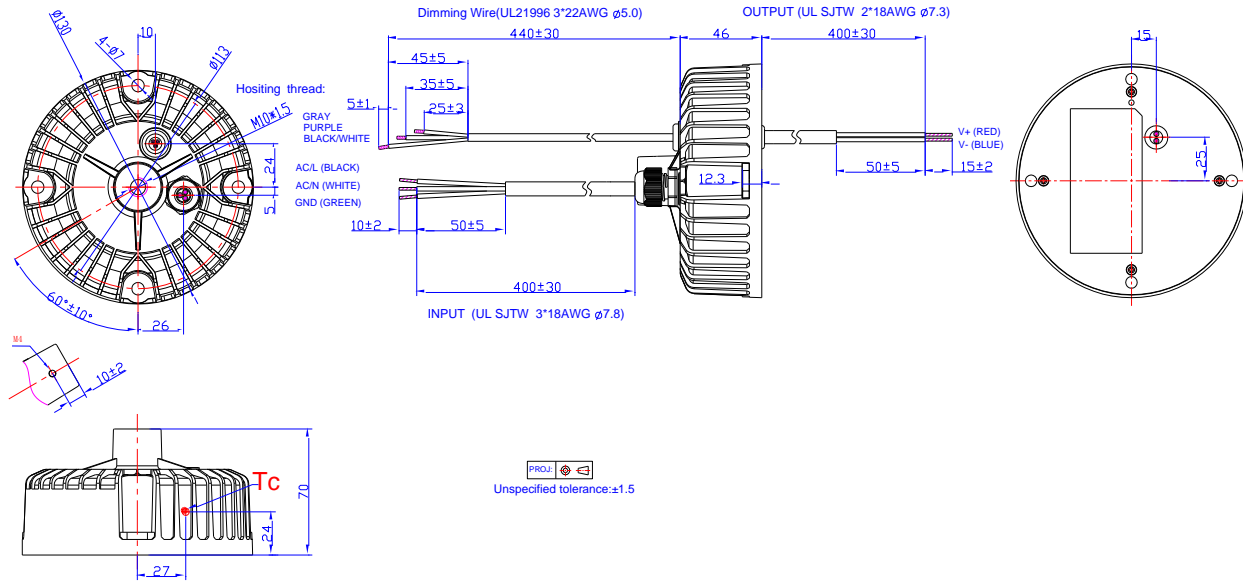

EUR-096SxxxST-0001

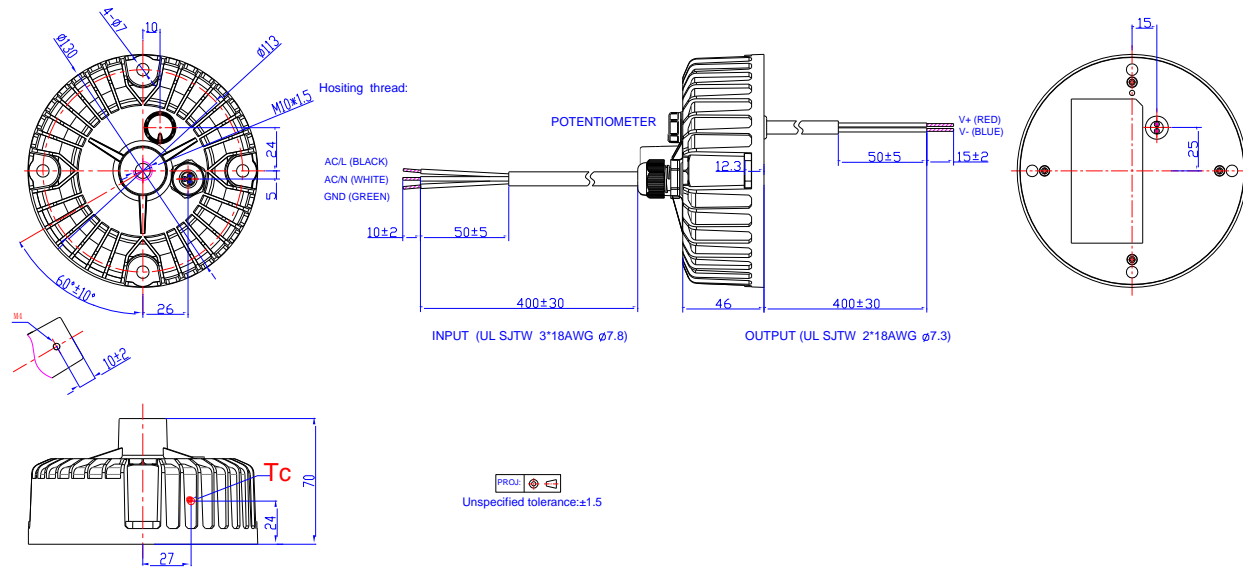

Optional Metal Parts

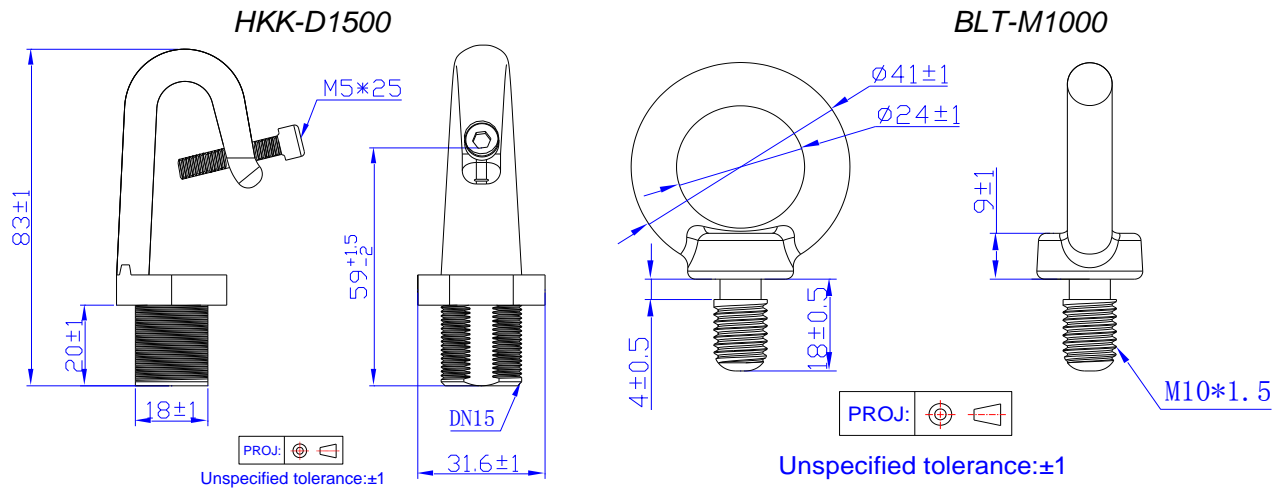

RoHS Compliance

Our products comply with the European Directive 2011/65/EC, calling for the elimination of lead and other hazardous substances from electronic products.

Revision History

Change Date	Rev.	Description of Change		
		Item	From	To
2016-07-08	A	Datasheets Release	/	/
2017-02-05	B	Features	/	Updated
		Mechanical Outline	/	Updated
2017-07-06	C	Input Specifications	PF/THD (Notes)	Updated
		Output Specifications	Temperature Coefficient of loset	Updated
		Safety & EMC Compliance	/	Updated
		Mechanical Outline	/	Updated
2018-03-05	D	Features	5 Years Warranty	Added
		Description	/	Updated
		Models	EUR-096S215DT/ST	Added
		Models	Notes(2)	Updated
		I-V Operation Area	EUR-096S215DT/ST	Added
		Output Current Setting(losset) Range	EUR-096S215DT/ST	Added
		Output Current Setting Range with Constant Power	EUR-096S215DT/ST	Added
		No Load Output Voltage	EUR-096S215DT/ST	Added
		Efficiency at 120 Vac input	EUR-096S215DT/ST	Added
		Efficiency at 220 Vac input	EUR-096S215DT/ST	Added
		Efficiency at 277 Vac input	EUR-096S215DT/ST	Added
		General Specifications	Case temperature for 5 years warranty	Updated
		Dimming Output Range	EUR-096S215DT	Added
		Efficiency vs. Load	EUR-096S215DT/ST	Added
Mechanical Outline	Optional Metal Parts	Added		
2018-03-20	E	Features	High Efficiency	Updated
		Models	/	Updated
		I-V Operation Area	/	Updated
		Output Current Setting(losset) Range	/	Updated
		Output Current Setting Range with Constant Power	/	Updated
		No Load Output Voltage	/	Updated
		Efficiency at 120 Vac input	/	Updated
		Efficiency at 220 Vac input	/	Updated
		Efficiency at 277 Vac input	/	Updated
		Efficiency vs. Load	/	Updated