

REVISIONS			
REV	ECN, ERN NO.	DATE	APPRD.
C	PRODUCT DRAWING (EAR 12900)	JAN23/06	K.L.

ORDERING CODE: F C E 1 7 - E 0 9 P E - A 8 0 G

SERIES
FCE17=FILTERED D-SUB, RoHS

SIZE/NUMBER OF CONTACTS
E09, A15, B25, OR C37

CONNECTOR STYLE
P=PIN
S=SOCKET

TERMINATION TYPE
E=VERTICAL MOUNT PCB TAIL

CONTACT FINISH/GOLD THICKNESS
NO DIGIT=STANDARD 15 MICRONS
[0.38 MICRONS] GOLD ON MATING AREA
G=50 MICRONS [1.27 MICRONS]
GOLD ON MATING AREA

MODIFIER
0=STANDARD

FILTER CAPACITANCE
D=50 pF 7=1200 pF
B=100 pF 6=1300 pF (PROPOSED)
O=180 pF J=1500 pF
F=330 pF E=2200 pF
1=470 pF 9=5600 pF
4=820 pF 8=47000 pF
5=1000 pF N=NO FILTERS

REFER TO AMPHENOL CATALOGUE FOR FILTER PERFORMANCE CHARACTERISTICS

MOUNTING
2=.120[3.05] DIA THROUGH HOLE
3=#4-40 UNC SELF-LOCKING THREAD
4=#4-40 UNC THREAD
5=#4-40 UNC THREADED STANDOFF
6=M3 x 0.5 THREAD
9=STANDOFF WITH BOARDLOCK & #4-40 THREADED JACK SOCKETS INSTALLED
A=#4-40 THREADED STANDOFF WITH BOARDLOCK
E=CODE 4 MOUNTING WITH #4-40 UNC HEX JACK SOCKETS SUPPLIED
J=M3 x 0.5 THREADED STANDOFF WITH BOARDLOCK

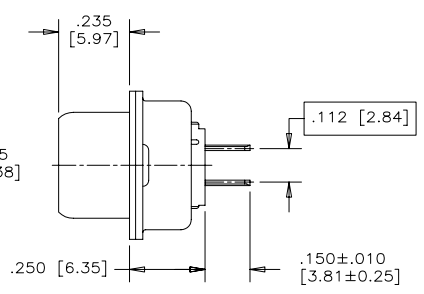
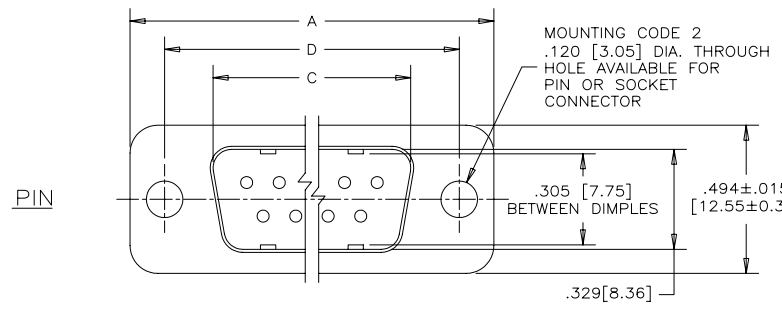
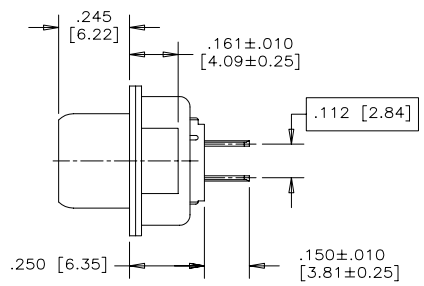
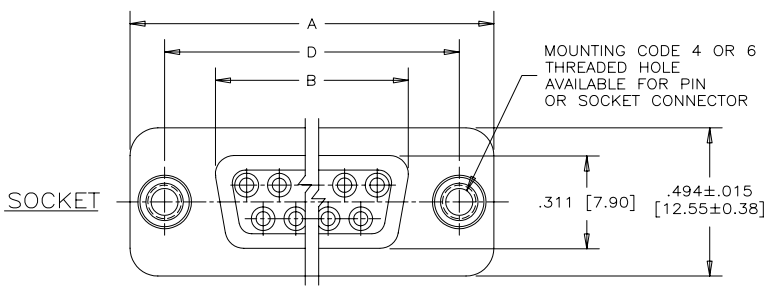
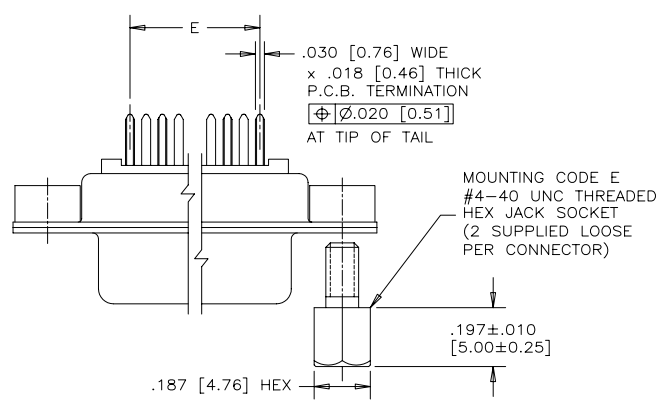

NOTES:

- MATERIALS: ALL MATERIALS ARE RoHS COMPLIANT.
 - SHELL: STEEL, TIN PLATED
 - CONTACTS: PHOSPHOR BRONZE, PLATED WITH GOLD OVER 50µ" [1.27 MICRONS] MINIMUM NICKEL IN THE MATING AREA AND 100µ" [2.54 MICRONS] MINIMUM MATTE TIN ON THE TAILS
 - INSULATOR: ENGINEERING THERMOPLASTIC, GLASS REINFORCED, UL FLAMMABILITY RATING 94V-0, COLOUR: BLACK
 - BOARDLOCK: COPPER ALLOY, TIN PLATED
 - MOUNTING HARDWARE, STEEL OR COPPER ALLOY, TIN OR NICKEL PLATED.
- CONTACT RESISTANCE: 15 MILLIOHMS MAXIMUM
- INSULATION RESISTANCE: 3000 MEGOHMS MINIMUM
- CURRENT RATING: 5 AMPS MAXIMUM
- OPERATING TEMPERATURE: -40°C TO 85°C
- TOLERANCE UNLESS INDICATED OTHERWISE: ±.005 [0.13]

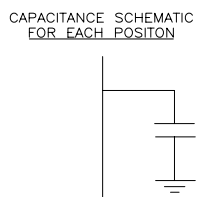
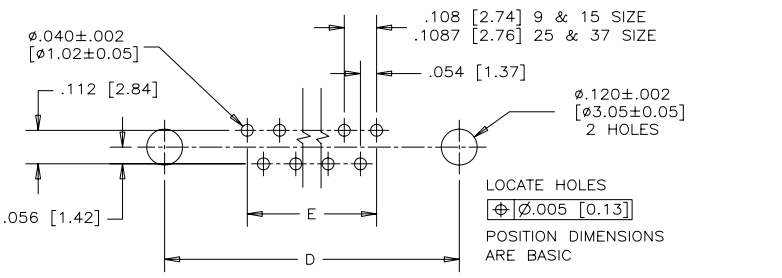

SIZE	STYLE	A±.015 [0.38]	B±.005 [0.13]	C±.005 [0.13]	D±.005 [0.13]	E BSC.
E09	PIN	1.213 [30.81]	-----	.666 [16.92]	.984 [24.99]	.432 [10.97]
	SOCKET	-----	.643 [16.33]	-----	-----	-----
A15	PIN	1.541 [39.14]	-----	.994 [25.25]	1.312 [33.32]	.756 [19.20]
	SOCKET	-----	.971 [24.66]	-----	-----	-----
B25	PIN	2.088 [53.04]	-----	1.534 [38.96]	1.852 [47.04]	1.304 [33.12]
	SOCKET	-----	1.511 [38.38]	-----	-----	-----
C37	PIN	2.729 [69.32]	-----	2.182 [55.42]	2.500 [63.50]	1.956 [49.68]
	SOCKET	-----	2.159 [54.84]	-----	-----	-----

RECOMMENDED P.C.B. LAYOUT (COMPONENT SIDE OF BOARD)

SEE SHEET #2 FOR ADDITIONAL MOUNTING OPTIONS.

DRAWN K. LAMBIE	DATE MAY13/05
DESIGNED	
CHECKED	
I. E. APPRD.	
Q. A. APPRD.	
DWG. APPRD.	
ENG. REL. NO.	
REF. EAR #12744	
DIMENSIONS ARE IN INCHES [mm]	CODE ID. NO. 03554

Amphenol Canada Corp.	
TITLE FCE17 SERIES FILTERED D-SUB CONNECTOR, PIN & SOCKET, VERTICAL MOUNT PCB TAIL, VARIOUS MOUNTING OPTIONS, RoHS COMPLIANT	
DWG. C	DRAWING NO. P-FCE17-XXXXE-XX0X
SCALE 3/1	WT. ----- SURF. ----- SHEET 1 of 2

THIS DOCUMENT CONTAINS PROPRIETARY INFORMATION AND SUCH INFORMATION MAY NOT BE DISCLOSED TO OTHERS FOR ANY PURPOSE OR USED FOR MANUFACTURING PURPOSES WITHOUT WRITTEN PERMISSION FROM AMPHENOL CANADA CORP.

REVISIONS			
REV	ECN, ERN NO.	DATE	APPRD.
C	PRODUCT DRAWING (EAR 12900)	JAN23/06	K.L.

ADDITIONAL MOUNTING OPTIONS AVAILABLE FOR PIN OR SOCKET CONNECTOR

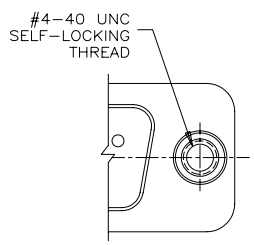

PARTIAL FRONT VIEW

MOUNTING CODE 3

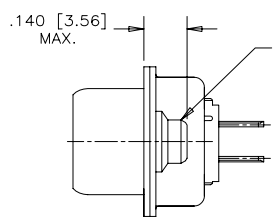

END VIEW

VIEW FOR E09, A15 & B25 SIZE. FOR C37 SIZE VIEW SEE MOUNTING CODE 4, SHEET 1.

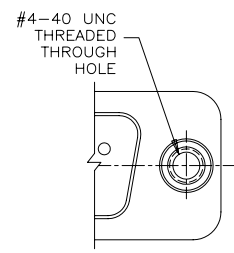

PARTIAL FRONT VIEW

MOUNTING CODE 5

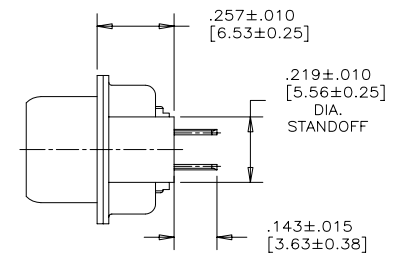

END VIEW

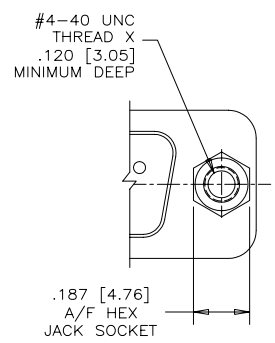

PARTIAL FRONT VIEW

MOUNTING CODE 9

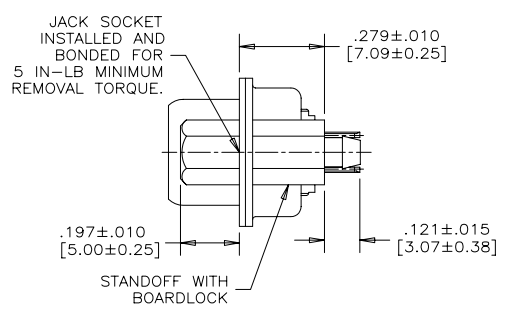

END VIEW

MOUNTING CODE A - #4-40 UNC
MOUNTING CODE J - M3 x 0.5
THREAD DEPTH .220 [5.59] MIN.

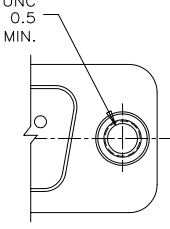

PARTIAL FRONT VIEW

MOUNTING CODES A & J

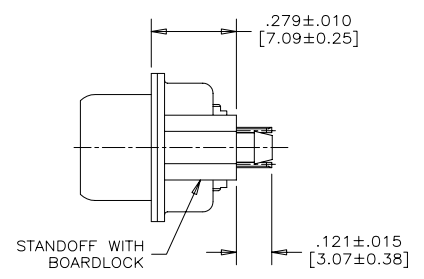

END VIEW

THIS DOCUMENT CONTAINS PROPRIETARY INFORMATION AND SUCH INFORMATION MAY NOT BE DISCLOSED TO OTHERS FOR ANY PURPOSE OR USED FOR MANUFACTURING PURPOSES WITHOUT WRITTEN PERMISSION FROM AMPHENOL CANADA CORP.

DRAWN K. LAMBIE	DATE MAY13/05	Amphenol Canada Corp.	
DESIGNED			
CHECKED		TITLE	
I. E. APPRD.		FCE17 SERIES FILTERED D-SUB CONNECTOR, PIN & SOCKET, VERTICAL MOUNT PCB TAIL, VARIOUS MOUNTING OPTIONS, RoHS COMPLIANT	
DWG. APPRD.		DWG	DRAWING NO.
ENG. REL. NO.		C	P-FCE17-XXXXE-XX0X
REF. EAR #12744		REV.	C
DIMENSIONS ARE IN INCHES [mm]	CODE ID. NO. 03554	SCALE 3/1	WT. ----- SURF. ----- SHEET 2 OF 2