



WGF65R290G

Features:

- Super Junction technology.
- Much lower $R_{on} \cdot A$ performance for On-state efficiency.
- Better efficiency due to very low FOM.
- Qualified for industrial grade applications according to JEDEC.
- $BVDSS=650V, I_D=13A$
- $R_{DS(on)} : 0.3\Omega$ (Max) @ $V_G=10V$
- 100% Avalanche Tested

TO-220F

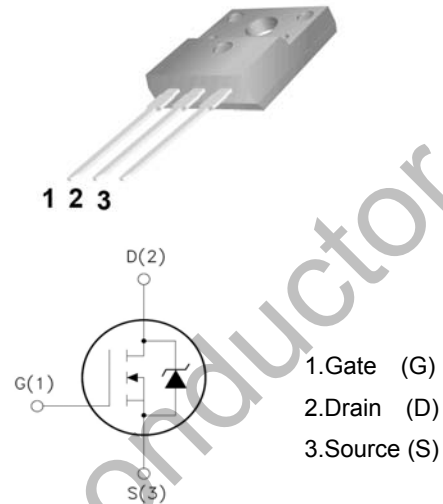
**Absolute Maximum Ratings** ($T_a=25^\circ\text{C}$ unless otherwise noted)

Symbol	Parameter	Value	Unit
V_{DSS}	Drain-Source Voltage	650	V
I_D	Drain Current ¹⁾	$T_j=25^\circ\text{C}$	13
		$T_j=100^\circ\text{C}$	8
$I_{D,pulse}$	Pulsed Drain Current ²⁾ ($T_C=25^\circ\text{C}$, t_p limited by T_j max)	53	A
$V_{GS(TH)}$	Gate Threshold Voltage	± 30	V
E_{AS}	Single Pulse Avalanche Energy (note1)	120	mJ
I_{AR}	Avalanche Current (note2)	5	A
P_D	Power Dissipation ($T_j=25^\circ\text{C}$)	50	W
T_j	Junction Temperature(Max)	150	$^\circ\text{C}$
T_{stg}	Storage Temperature	-55~+150	$^\circ\text{C}$
TL	Maximum lead temperature for soldering purpose, 1/8" from case for 5 seconds	300	$^\circ\text{C}$

Thermal Characteristics

Symbol	Parameter	Typ.	Max.	Unit
$R_{\theta JC}$	Thermal Resistance, Junction to Case	-	1.04	$^\circ\text{C/W}$
$R_{\theta JA}$	Thermal Resistance, Junction to Ambient	-	62.5	$^\circ\text{C/W}$

Electrical Characteristics (Ta=25°C unless otherwise noted)

Symbol	Parameter	Test Condition	Min.	Typ.	Max.	Unit
Off Characteristics						
BV _{DSS}	Drain-Source Breakdown Voltage	I _D =250μA, V _{GS} =0	650	-	-	V
ΔBV _{DSS} /ΔT _J	Breakdown Voltage Temperature Coefficient	I _D =250μA, Reference to 25°C	-	0.6	-	V/°C
I _{DSS}	Zero Gate Voltage Drain Current	V _{DS} =650V, V _{GS} =0V	-	-	1	μA
		V _{DS} =520V, T _J =125°C	-	-	100	
I _{GSSF}	Gate-body leakage Current, Forward	V _{GS} =+30V, V _{DS} =0V	-	-	100	nA
I _{GSSR}	Gate-body leakage Current, Reverse	V _{GS} =-30V, V _{DS} =0V	-	-	-100	
On Characteristics						
V _{GS(TH)}	Gate Threshold Voltage	I _D =250μA, V _{DS} =V _{GS}	2	-	4	V
R _{DS(ON)}	Static Drain-Source On-Resistance	I _D =2.5A, V _{GS} =10V	-	-	2.5	Ω
Dynamic Characteristics						
C _{iss}	Input Capacitance	V _{DS} =25V, V _{GS} =0, f=1.0MHz	-	615	-	pF
C _{oss}	Output Capacitance		-	55	-	
C _{rss}	Reverse Transfer Capacitance		-	6.88	-	
Switching Characteristics						
T _{d(on)}	Turn-On Delay Time	V _{DD} =300V, I _D =5A R _G =25Ω (Note 3,4)	-	13	35	ns
T _r	Turn-On Rise Time		-	45	100	
T _{d(off)}	Turn-Off Delay Time		-	25	60	
T _f	Turn-Off Rise Time		-	35	80	
Q _g	Total Gate Charge	V _{DS} =520V, V _{GS} =10V, I _D =5A (Note 3,4)	-	17.3	-	nC
Q _{gs}	Gate-Source Charge		-	2.4	-	
Q _{gd}	Gate-Drain Charge		-	7.9	-	
Drain-Source Diode Characteristics and Maximum Ratings						
I _S	Max. Diode Forward Current	-	-	-	5	A
I _{SM}	Max. Pulsed Forward Current	-	-	-	16	
V _{SD}	Diode Forward Voltage	I _D =5A	-	-	1.35	V
T _{rr}	Reverse Recovery Time	I _S =5A, V _{GS} =0V diF/dt=100A/μs	-	390	-	nS
Q _{rr}	Reverse Recovery Charge	(Note3)	-	1.5	-	μC

- Notes : 1, L=25mH, I_{AS}=4A, V_{DD}=50V, R_G=25Ω, Starting T_J=25°C
 2, Repetitive Rating : Pulse width limited by maximum junction temperature
 3, Pulse Test : Pulse Width ≤ 300μs, Duty Cycle ≤ 2%
 4, Essentially Independent of Operating Temperature

Typical Characteristics

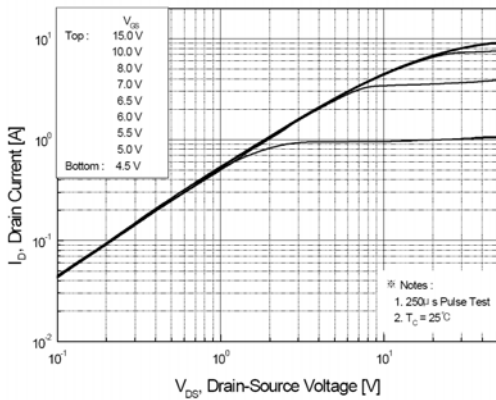

Figure 1. On-Region Characteristics

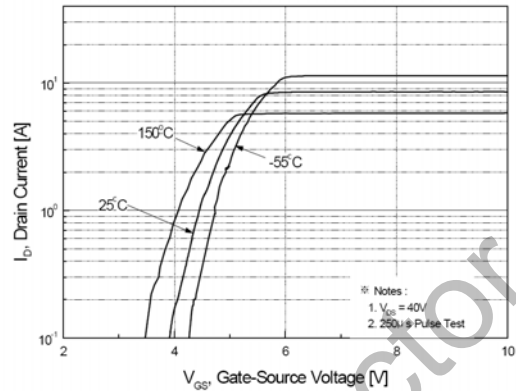

Figure 2. Transfer Characteristics

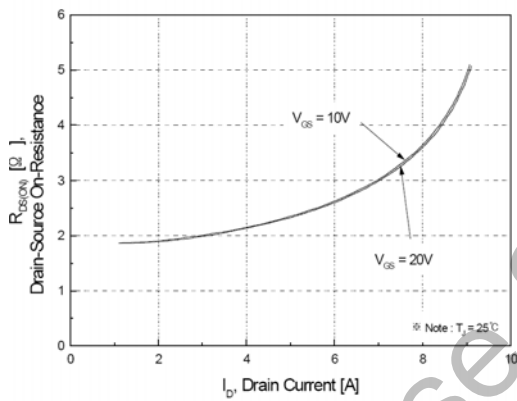

Figure 3. On-Resistance Variation vs Drain Current and Gate Voltage

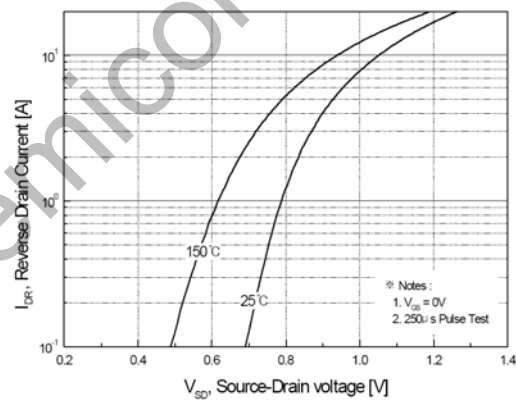

Figure 4. Body Diode Forward Voltage Variation with Source Current and Temperature

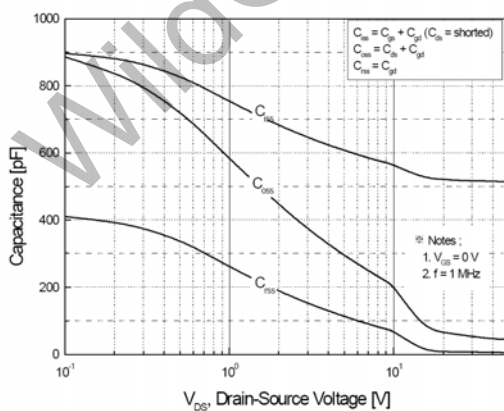

Figure 5. Capacitance Characteristics

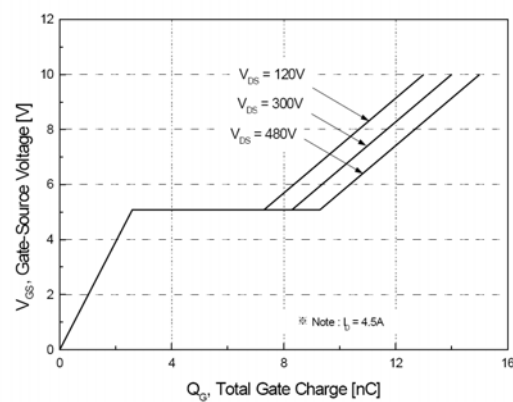

Figure 6. Gate Charge Characteristics

Typical Characteristics (Continued)

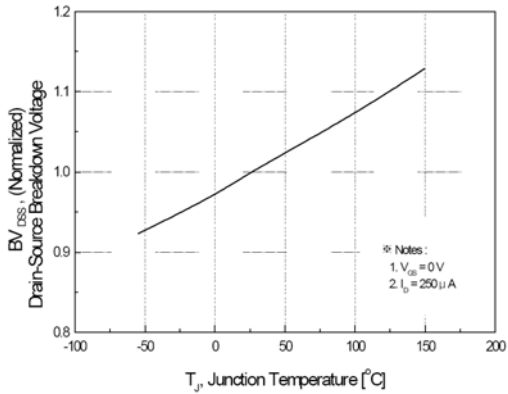

Figure 7. Breakdown Voltage Variation vs Temperature

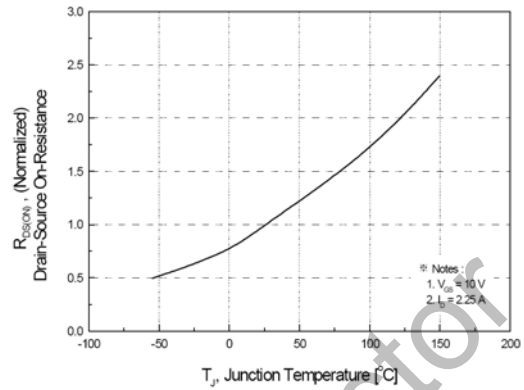

Figure 8. On-Resistance Variation vs Temperature

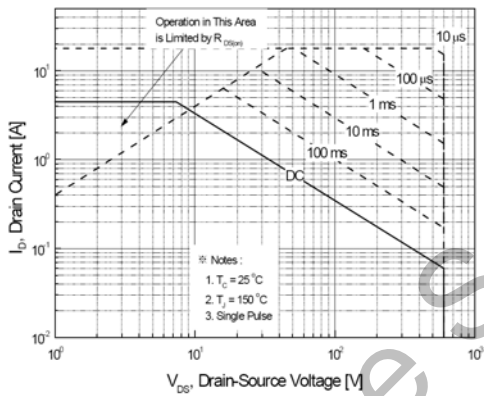

Figure 9. Maximum Safe Operating Area

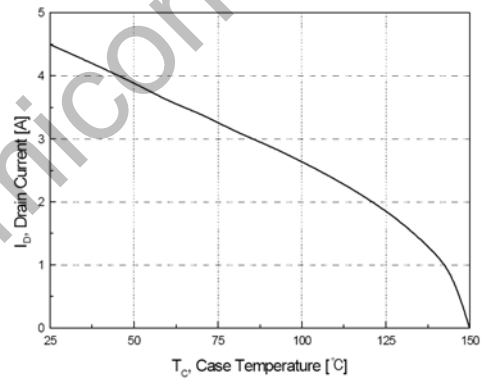

Figure 10. Maximum Drain Current vs Case Temperature

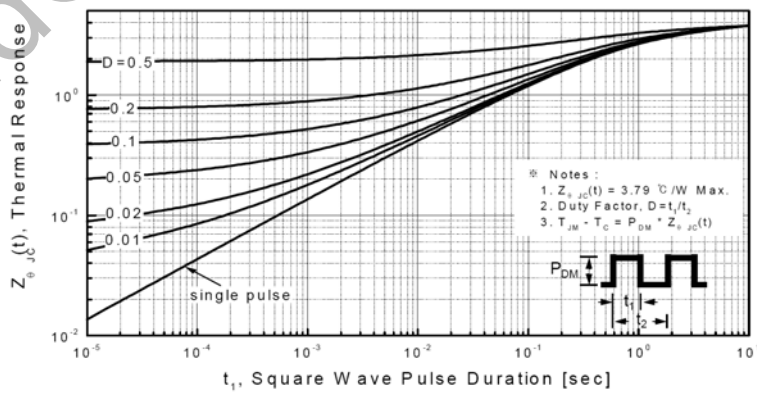
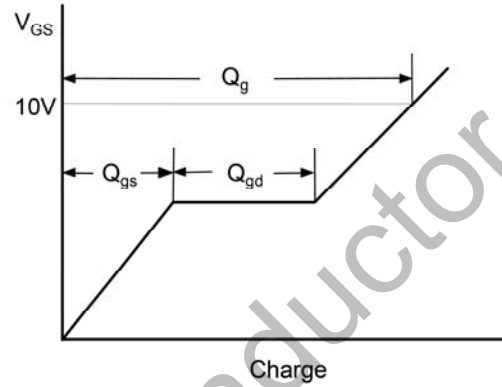
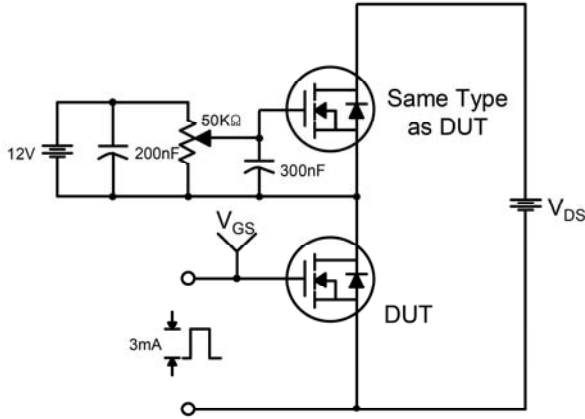
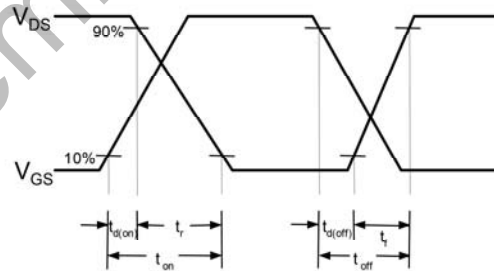
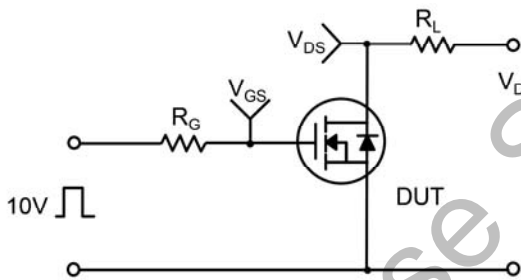

Figure 11. Transient Thermal Response Curve

Gate Charge Test Circuit & Waveform



Resistive Switching Test Circuit & Waveforms



Unclamped Inductive Switching Test Circuit & Waveforms

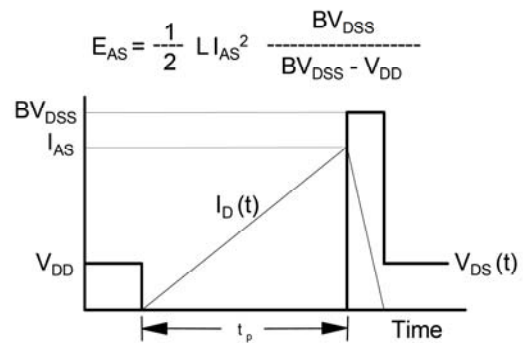
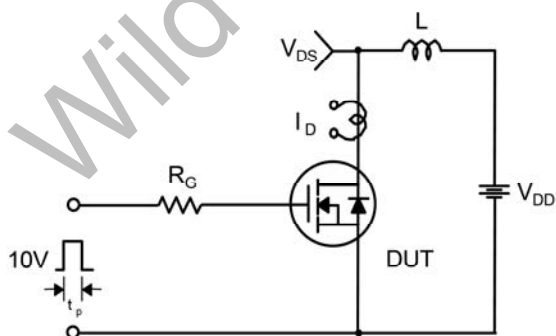

Peak Diode Recovery dv/dt Test Circuit & Waveform

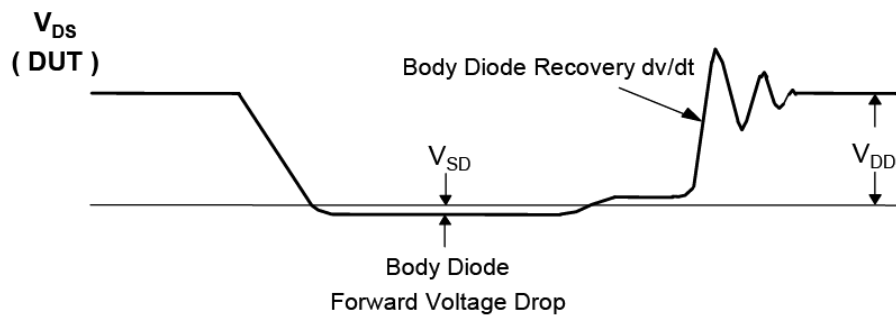
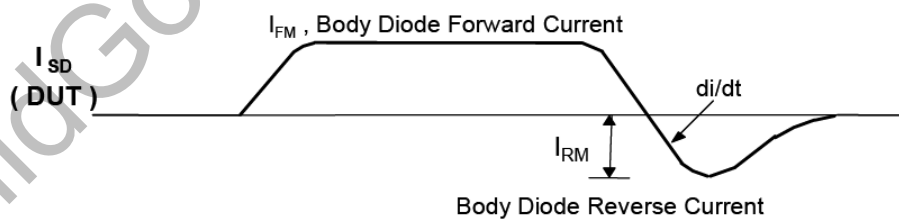
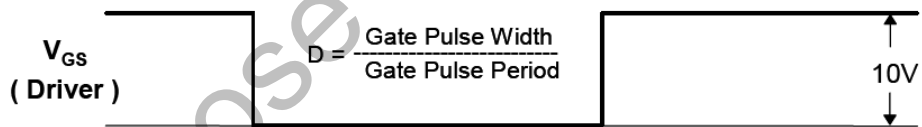
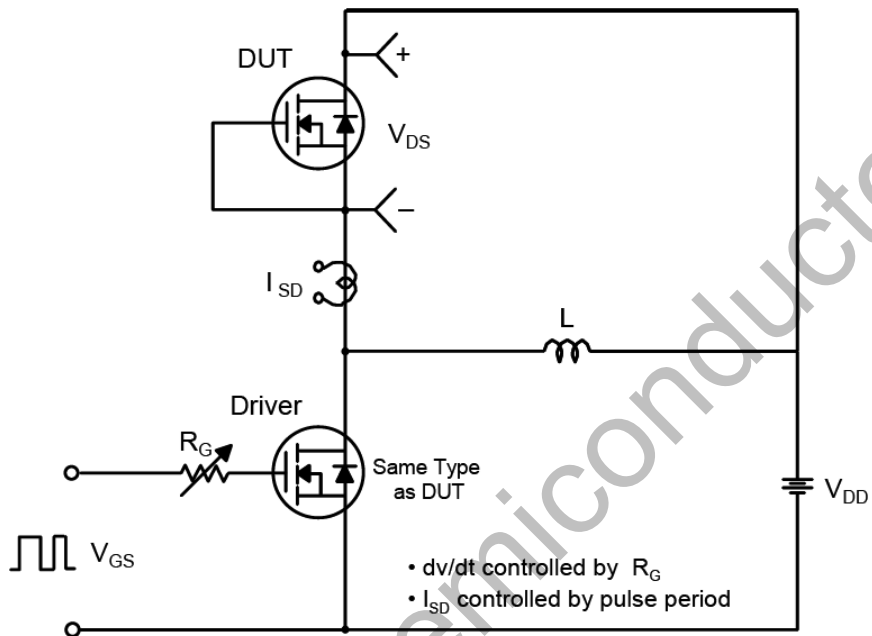

Package Dimension

TO-220F

Unit: mm

