

Features

- Inventronics patented metal case (Patent NO.: 201530552642.8)
- High Efficiency (Up to 93.0%)
- Full Power at Wide Output Current Range (Constant Power)
- Adjustable Output Current (AOC) with Potentiometer (ST models)
Adjustable Output Current (AOC) with Programmability (DT models)
- 0-10V/PWM Dimmable (Only DT models)
- Input surge protection: 4kV line-line, 4kV line-earth
- All-Around Protection: OVP, SCP, OTP
- Waterproof (IP65) and UL Dry / Damp / Wet Location
- SELV Output
- TYPE HL, for use in a Class I, Division 2 hazardous (Classified) location

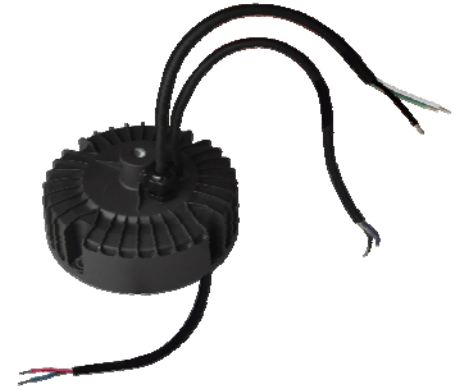

Description

The EUR-200SxxxDT(ST) series is a 200W, constant-current, AOC LED driver that operates from 90-305 Vac input with excellent power factor. It is designed in round shape and specially created for bay light. The high efficiency of these drivers and compact metal case enables them to run cooler, significantly improving reliability and extending product life. To ensure trouble-free operation, protection is provided against input surge, output over voltage, short circuit, and over temperature.

Models

Adjustable Output Current Range	Full-Power Current Range (1)	Default Output Current	Input Voltage Range (2)	Output Voltage Range	Max. Output Power	Typical Efficiency (3)	Power Factor		Model Number (4)
							120Vac	220Vac	
245-3500mA	2450-3500mA	3330 mA	90~305 Vac/ 127~300 Vdc	29 ~ 82Vdc	200W	93.0%	0.99	0.96	EUR-200S350DT
2450-3500mA	2450-3500mA	3330 mA	90~305 Vac/ 127~300 Vdc	29 ~ 82Vdc	200W	93.0%	0.99	0.96	EUR-200S350ST
385-5600mA	3850-5600mA	4160 mA	90~305 Vac/ 127~300 Vdc	18 ~ 52Vdc	200W	92.5%	0.99	0.96	EUR-200S560DT
3850-5600mA	3850-5600mA	4160 mA	90~305 Vac/ 127~300 Vdc	18 ~ 52Vdc	200W	92.5%	0.99	0.96	EUR-200S560ST

Notes: (1) Output current range with constant power at 200W

(2) UL, FCC certified input voltage range: 100-277Vac or 127-300Vdc; other certified input voltage range except UL & FCC: 100-240Vac or 127-250Vdc (except KS).

(3) Measured at full load and 220Vac input (see below "General Specifications" for details).

(4) SELV Output.

I-V Operation Area

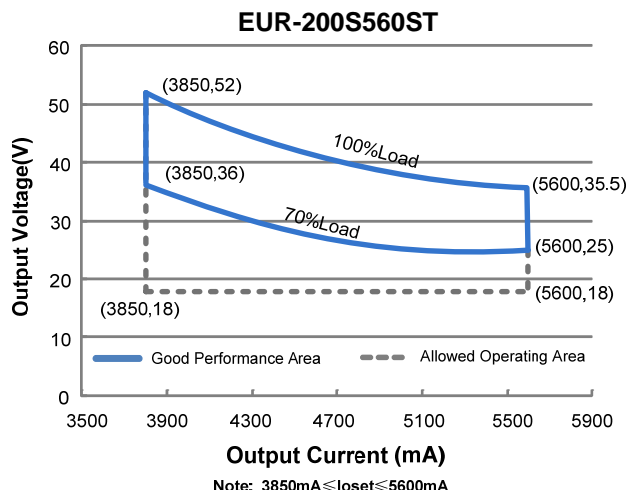
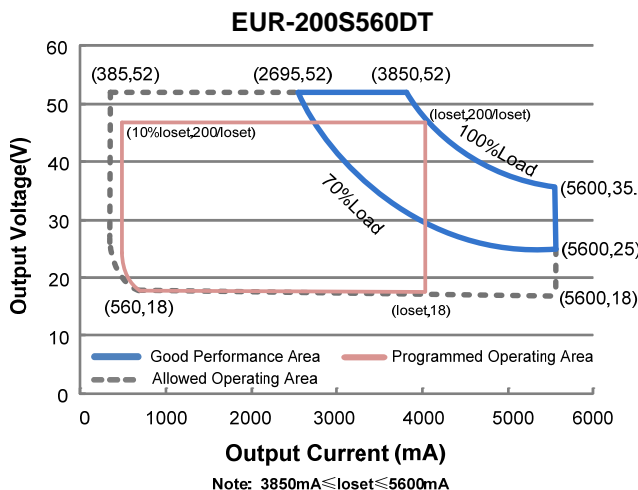
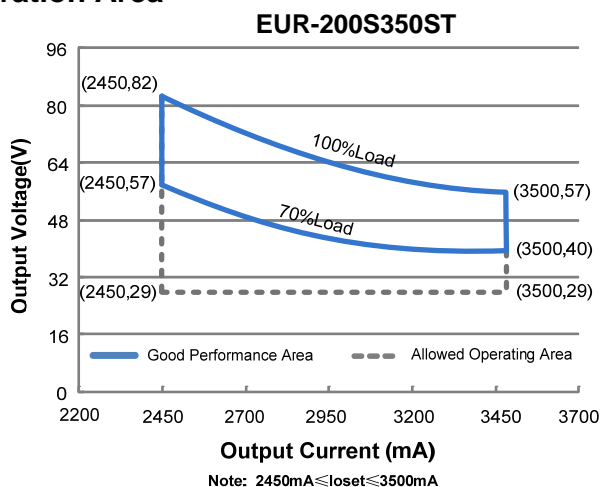
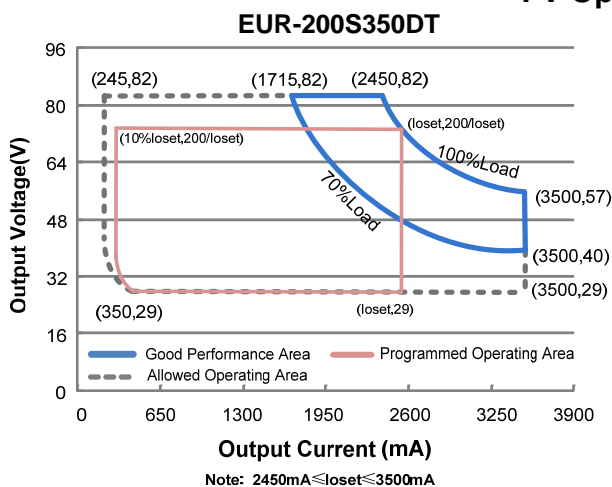

Input Specifications

Parameter	Min.	Typ.	Max.	Notes
Input Voltage	90 Vac	-	305 Vac	127~300 Vdc
Input Frequency	47 Hz	-	63 Hz	
Leakage Current	-	-	0.75 MIU	UL8750; 277Vac/ 60Hz
	-	-	0.70 mA	IEC60598-1; 240Vac/ 60Hz
Input AC Current	-	-	2.10 A	Measured at full load and 120 Vac input.
	-	-	1.10 A	Measured at full load and 220 Vac input.
Inrush Current(I^2t)	-	-	2.10 A ² s	At 220Vac input, 25°C cold start, duration=2.96 ms, 10%Ipk-10%Ipk. See Inrush Current Waveform for the details.
PF	0.9	-	-	At 100-277Vac, 50-60Hz, 70%-100% Load (140-200W)
THD	-	-	20%	
THD	-	-	10%	At 220-240Vac, 50-60Hz, 75%-100% Load (150-200W)

Output Specifications

Parameter	Min.	Typ.	Max.	Notes
Output Current Tolerance	-5%loset	-	5%loset	At full load condition
Output Current Setting(loset) Range				
EUR-200S350DT	245 mA	-	3500mA	
EUR-200S350ST	2450 mA	-	3500mA	
EUR-200S560DT	385 mA	-	5600mA	
EUR-200S560ST	3850 mA	-	5600mA	
Output Current Setting Range with Constant Power				
EUR-200S350DT	2450 mA	-	3500mA	
EUR-200S350ST	2450 mA	-	3500mA	
EUR-200S560DT	3850 mA	-	5600mA	
EUR-200S560ST	3850 mA	-	5600mA	
Total Output Current Ripple (pk-pk)	-	5%lomax	10%lomax	At full load condition. 20 MHz BW
Output Current Ripple at < 200 Hz (pk-pk)	-	2%lomax	-	At full load condition. Only this component of ripple is associated with visible flicker.
Startup Overshoot Current	-	-	10%lomax	At full load condition
No Load Output Voltage				
EUR-200S350DT/ST	-	-	100 V	
EUR-200S560DT/ST	-	-	60 V	
Line Regulation	-	-	±0.5%	Measured at full load
Load Regulation	-	-	±1.5%	
Turn-on Delay Time	-	-	1.0 s	Measured at 120Vac input, 70%-100% Load
	-	-	0.5 s	Measured at 220Vac input, 70%-100% Load
Temperature Coefficient of loiset	-	0.03%/°C	-	Case temperature = 0°C ~Tc max
12V Auxiliary Output Voltage	10.8 V	12 V	13.2 V	
12V Auxiliary Output Source Current	0 mA	-	20 mA	Return terminal is "Dim"

Note: All specifications are typical at 25°C unless otherwise stated.

General Specifications

Parameter	Min.	Typ.	Max.	Notes
Efficiency at 120 Vac input:				
EUR-200S350DT/ST				Measured at full load and steady-state temperature in 25°C ambient; (Efficiency will be about 2.0% lower if measured immediately after startup.)
Io=2450 mA	88.0%	90.0%	-	
Io=3500 mA	86.5%	88.5%	-	
EUR-200S560DT/ST				
Io=3850 mA	88.0%	90.0%	-	
Io=5600 mA	86.0%	88.0%	-	
Efficiency at 220 Vac input:				
EUR-200S350DT/ST				Measured at full load and steady-state temperature in 25°C ambient; (Efficiency will be about 2.0% lower if measured immediately after startup.)
Io=2450 mA	91.0%	93.0%	-	
Io=3500 mA	89.0%	91.0%	-	
EUR-200S560DT/ST				
Io=3850 mA	90.5%	92.5%	-	
Io=5600 mA	89.0%	91.0%	-	

General Specifications (Continued)

Parameter	Min.	Typ.	Max.	Notes
Efficiency at 277 Vac input: EUR-200S350DT/ST I _o =2450 mA I _o =3500 mA EUR-200S560DT/ST I _o =3850 mA I _o =5600 mA	91.5% 89.5% 91.0% 89.5%	93.5% 91.5% 93.0% 91.5%	- - - -	Measured at full load and steady-state temperature in 25°C ambient; (Efficiency will be about 2.0% lower if measured immediately after startup.)
MTBF	-	238,000 Hours	-	Measured at 220Vac input, 80%Load and 25°C ambient temperature (MIL-HDBK-217F)
Lifetime	-	82,000 Hours	-	Measured at 220Vac input, 80%Load and 70°C case temperature; See lifetime vs. Tc curve for the details
Operating Case Temperature for Safety T _{c_s}	-40°C	-	+85°C	
Operating Case Temperature for Warranty T _{c_w}	-40°C	-	+75°C	
Storage Temperature	-40°C	-	+85°C	Humidity: 5%RH to 100%RH
Dimensions Inches (Ø × H) Millimeters (Ø × H)	Ø5.90 x 2.83 Ø150 x 72			
Net Weight	-	1650 g	-	

Note: All specifications are typical at 25°C unless otherwise stated.

Dimming Specifications

Parameter	Min.	Typ.	Max.	Notes	
Absolute Maximum Voltage on the V _{dim} (+) Pin	-20 V	-	20 V		
Source Current on V _{dim} (+)Pin	200 uA	300 uA	450 uA	V _{dim} (+) = 0 V	
Dimming Output Range	EUR-200S350DT EUR-200S560DT	10%loset	-	loset	2450 mA ≤ I _o set ≤ 3500 mA 3850 mA ≤ I _o set ≤ 5600 mA
	EUR-200S350DT EUR-200S560DT	245 mA 385 mA	-	loset	245 mA ≤ I _o set < 2450 mA 385 mA ≤ I _o set < 3850 mA
Recommended Dimming Input Range	0 V	-	10 V	Default 0-10V dimming mode.	
PWM_in High Level	3 V	-	10 V	Dimming mode set to PWM in PC interface.	
PWM_in Low Level	-0.3 V	-	0.6 V		
PWM_in Frequency Range	200 Hz	-	2 KHz		
PWM_in Duty Cycle	1%	-	99%		

Safety & EMC Compliance

Safety Category	Standard
UL/CUL	UL8750,CAN/CSA-C22.2 No. 250.13
CE	EN 61347-1, EN61347-2-13
KS	KS C 7655
EMI Standards	Notes
EN 55015 ⁽¹⁾	Conducted emission Test & Radiated emission Test
EN 61000-3-2	Harmonic current emissions
EN 61000-3-3	Voltage fluctuations & flicker
FCC Part 15 ⁽¹⁾	ANSI C63.4 Class B
	This device complies with Part 15 of the FCC Rules. Operation is subject to the following two conditions: [1] this device may not cause harmful interference, and [2] this device must accept any interference received, including interference that may cause undesired Operation.
EMS Standards	Notes
EN 61000-4-2	Electrostatic Discharge (ESD): 8 kV air discharge, 4 kV contact discharge
EN 61000-4-3	Radio-Frequency Electromagnetic Field Susceptibility Test-RS
EN 61000-4-4	Electrical Fast Transient / Burst-EFT
EN 61000-4-5	Surge Immunity Test: AC Power Line: line to line 4 kV, line to earth 4kV
EN 61000-4-6	Conducted Radio Frequency Disturbances Test-CS
EN 61000-4-8	Power Frequency Magnetic Field Test
EN 61000-4-11	Voltage Dips
EN 61547	Electromagnetic Immunity Requirements Applies To Lighting Equipment

Note: (1) This LED driver meets the EMI specifications above, but EMI performance of a luminaire that contains it depends also on the other devices connected to the driver and on the fixture itself.

Derating

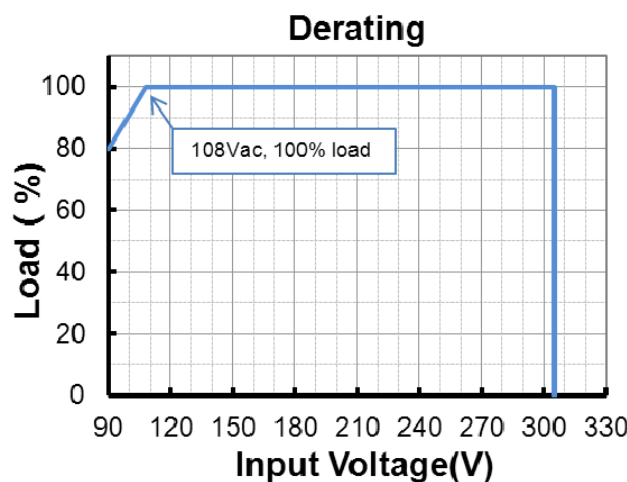

Lifetime vs. Case Temperature

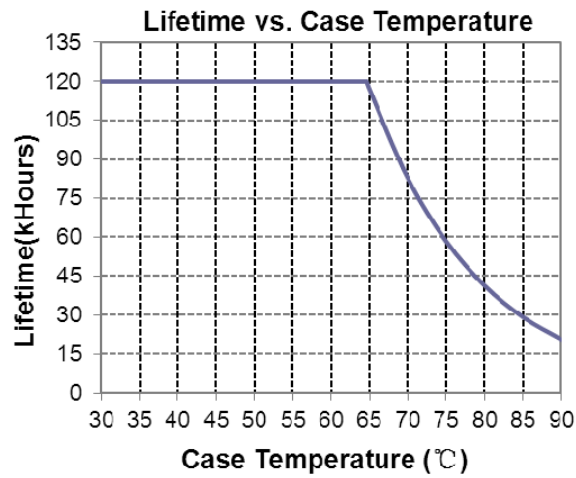

Inrush Current Waveform

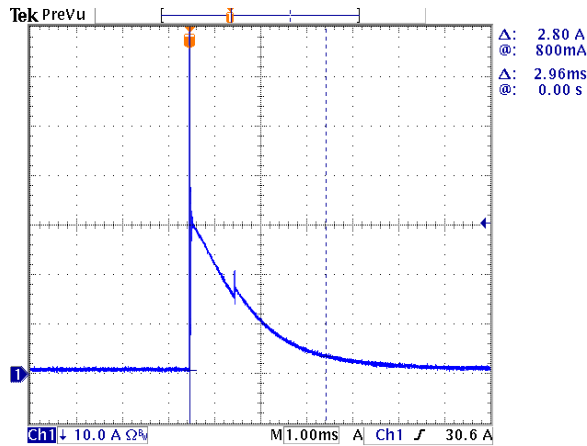

Efficiency vs. Load

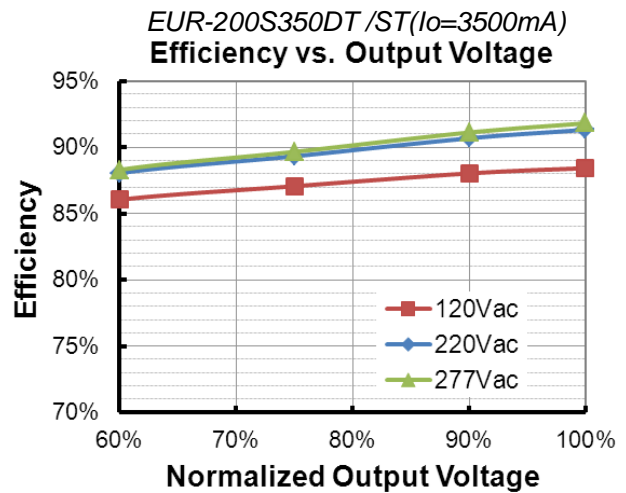
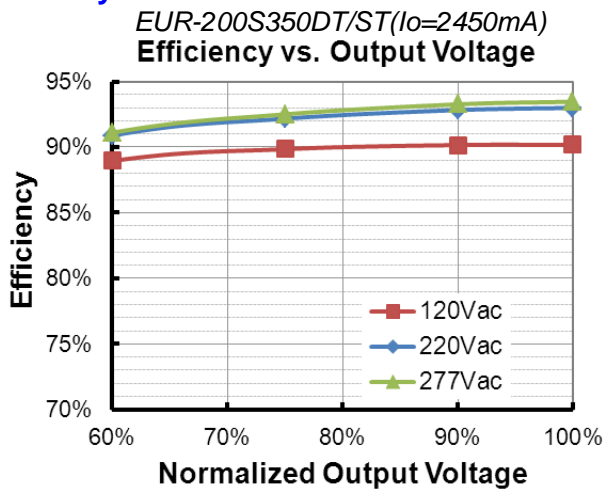

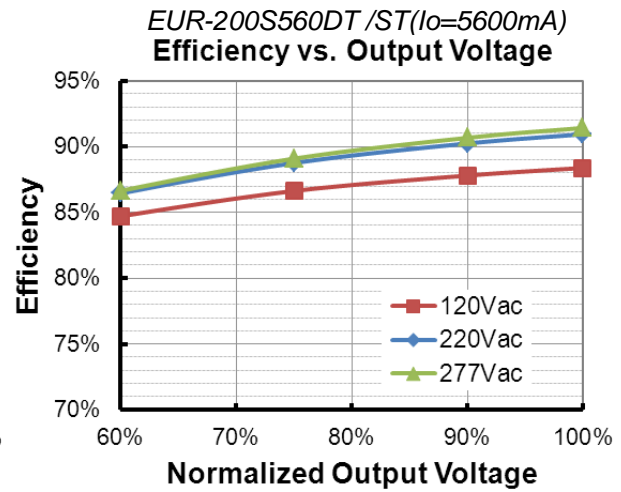
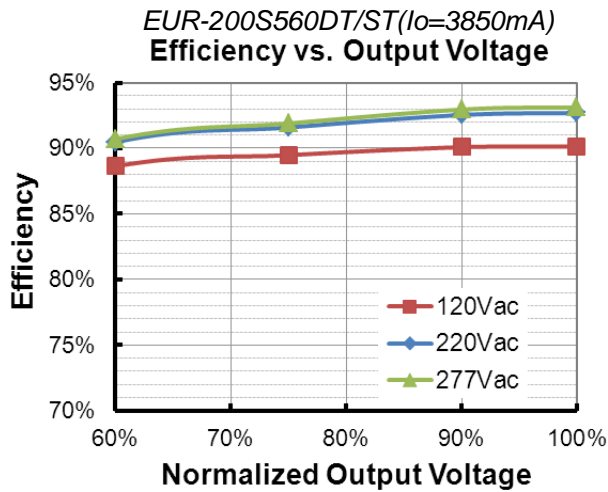

Power Factor

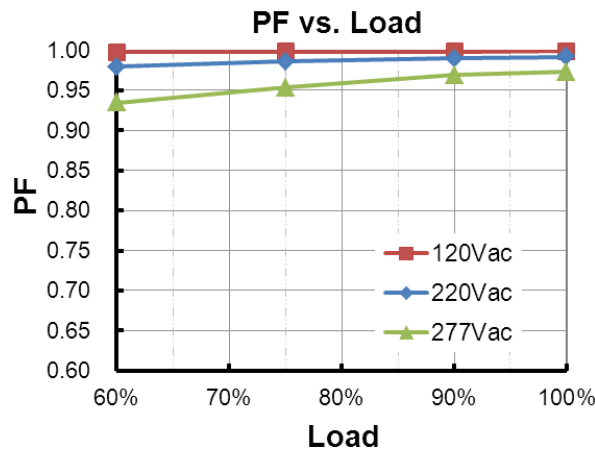

Total Harmonic Distortion

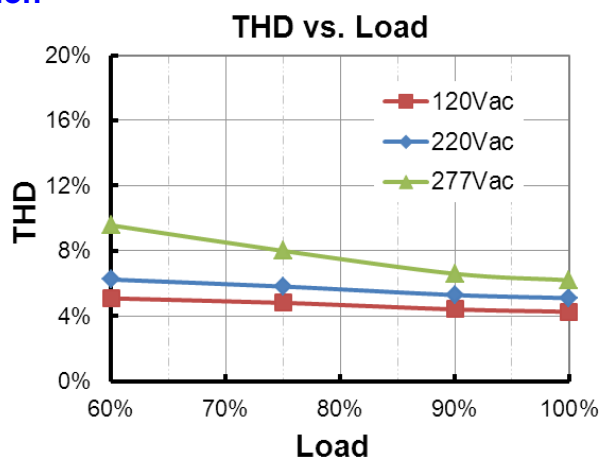

Protection Functions

Parameter	Notes
Over Temperature Protection	Decreases output current, returning to normal after over temperature is removed.
Short Circuit Protection	Auto Recovery. No damage will occur when any output is short circuited. The output shall return to normal when the fault condition is removed.
Over Voltage Protection	Limits output voltage at no load and in case the normal voltage limit fails.

Dimming

● 0-10V Dimming

The recommended implementation of the dimming control is provided below.

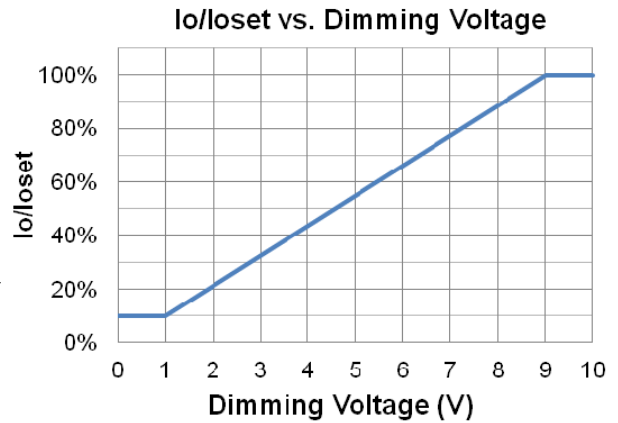
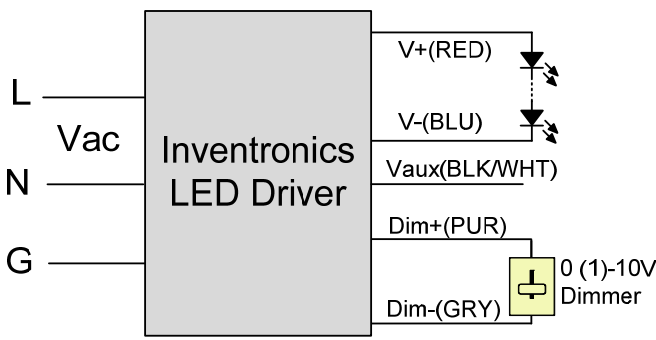

Implementation 1: DC Input

Notes:

1. The dimmer can also be replaced by an active 0-10V voltage source signal or passive components like resistors and zener.
2. Do NOT connect Dim- to the output V- or V+, otherwise the driver will not work properly.
3. If 0-10V dimming is not used, Dim + should be open.

● PWM Dimming

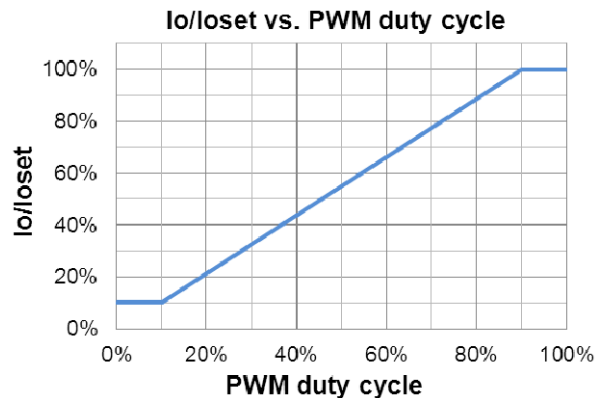
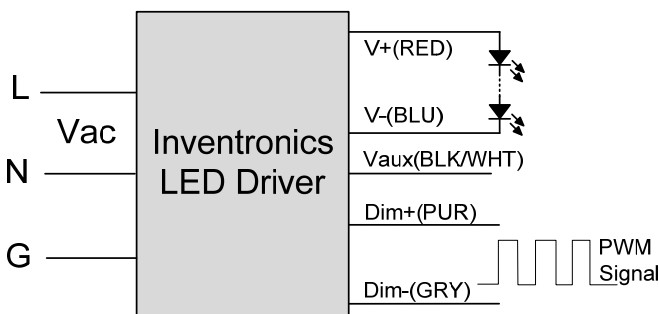

Implementation 2: Positive logic

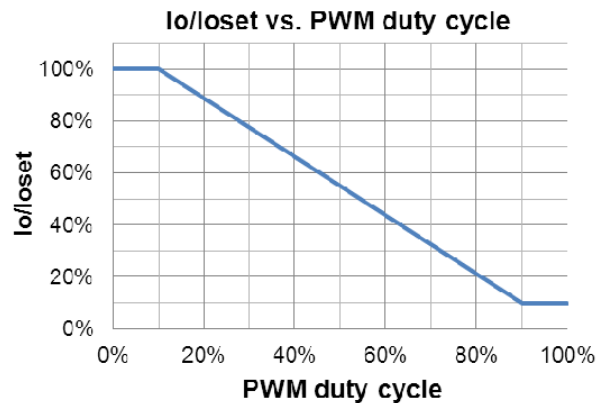
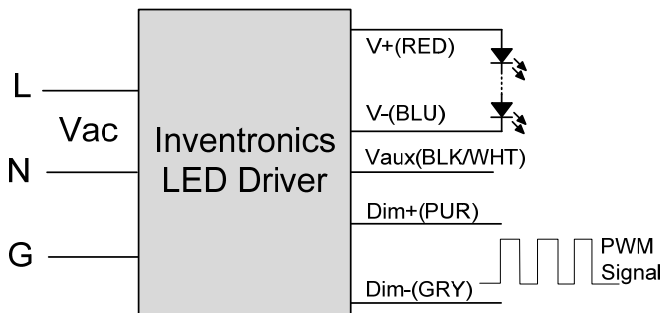

Implementation 3: Negative logic

Notes:

1. Do NOT connect Dim- to the output V- or V+, otherwise the driver will not work properly.
2. If PWM dimming is not used, Dim + should be open.
3. When PWM negative logic dimming mode and Dim+ is open, the driver will output minimum current.

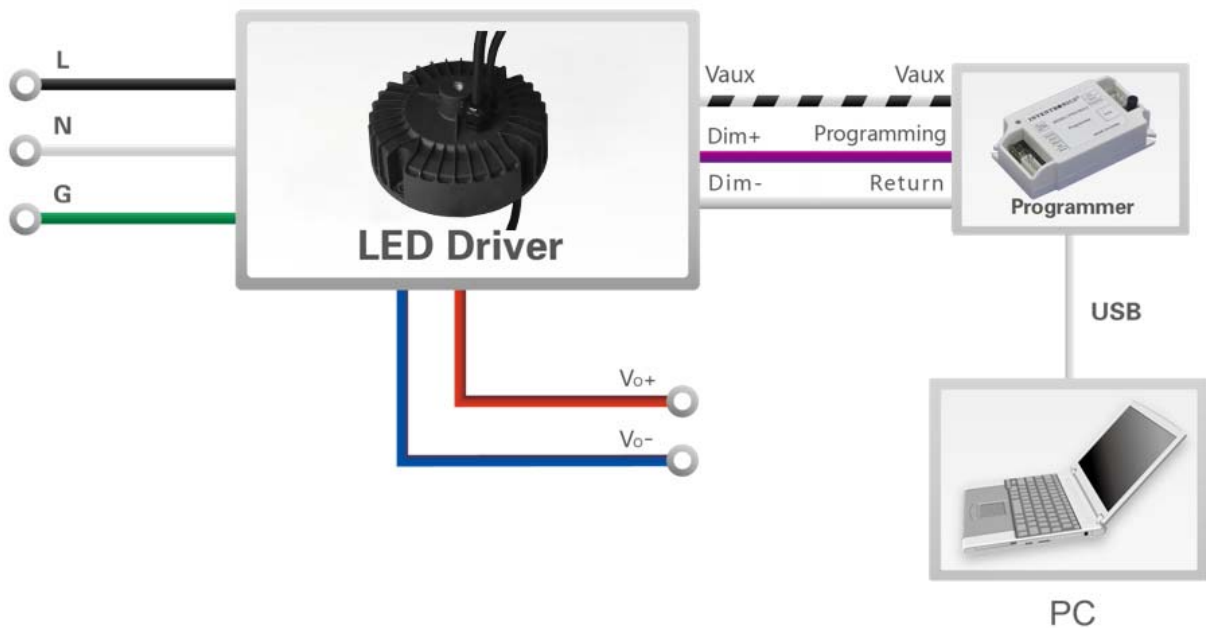

Programming Connection Diagram (Only DT models)



Note: The driver does not need to be powered on during the programming process.

- Please refer to [PRG-MUL2](#) Multi-Programmer datasheet for details.

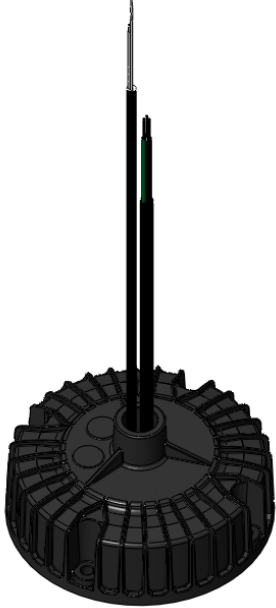
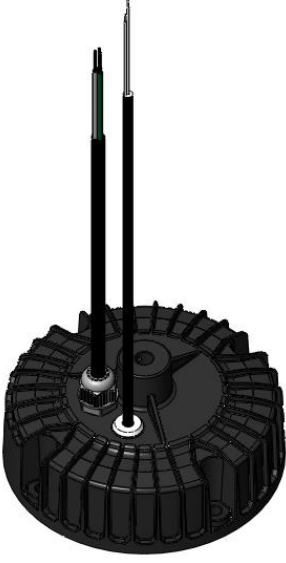
Installations

Part Number Suffix	-0000	-0001
Product Type	Center Wire Feed	Outside Wire Feed
Product Appearance		
Installation Type		

Caution:

1. Complete visual inspection prior to assembly to insure driver is received in proper condition.
2. Thread length for mounting accessory (hook, ring, etc.) should be 16-22mm. After mounting accessory (hook, ring, etc.) is installed an M4 set screw should be secured in the open location on the driver collar.
3. Maximum weight of combined luminaire/driver assembly should not exceed 11Kg.

Mechanical Outline

EUR-200SxxxDT-0000

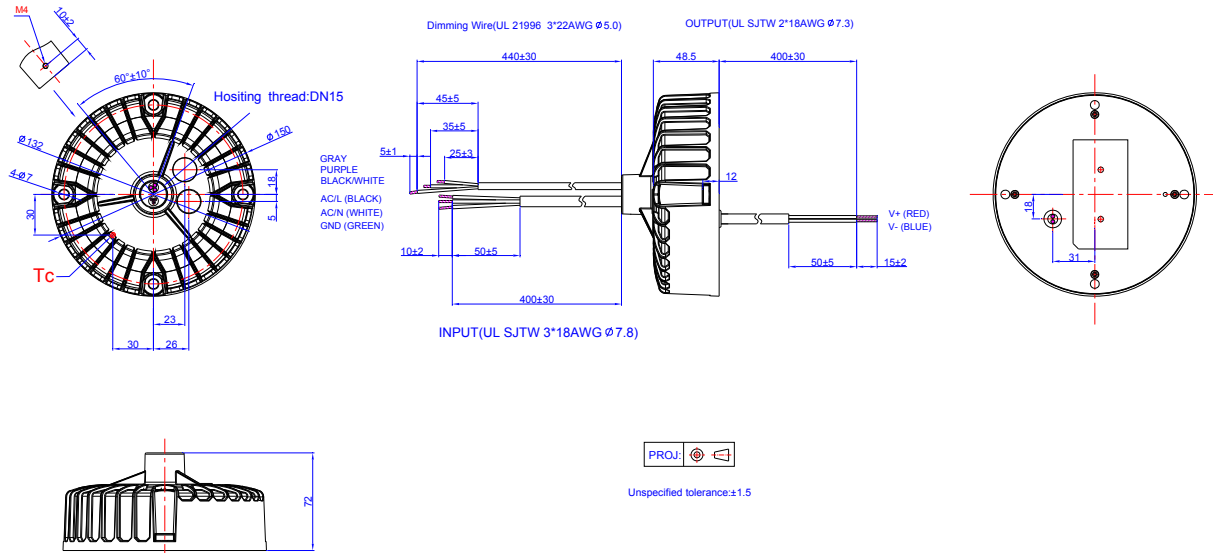

EUR-200SxxxST-0000

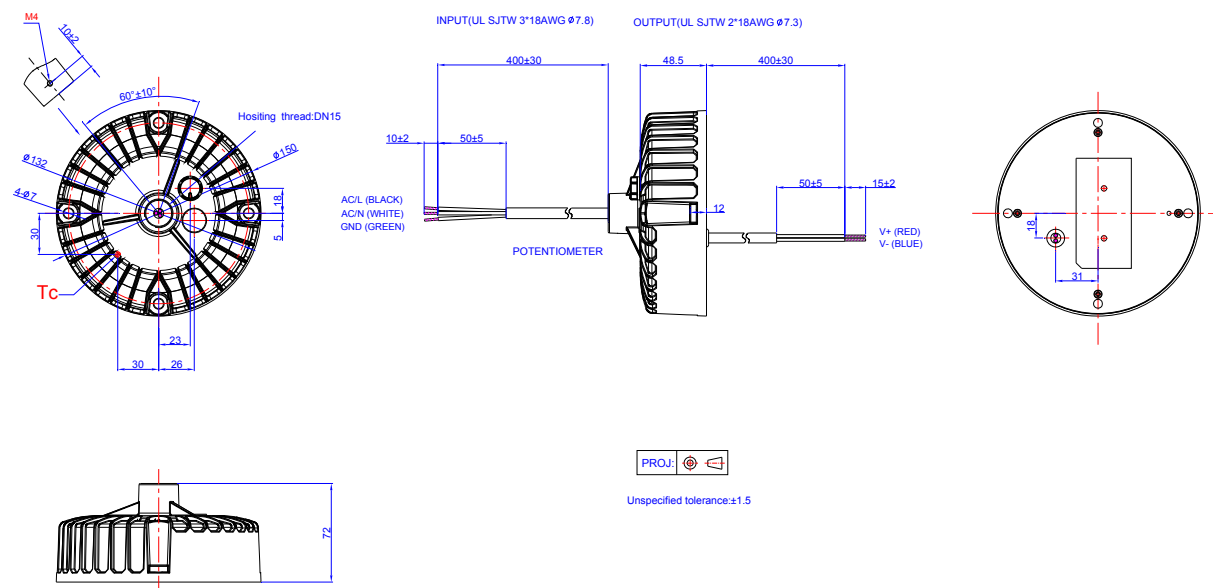

EUR-200SxxxDT-0001

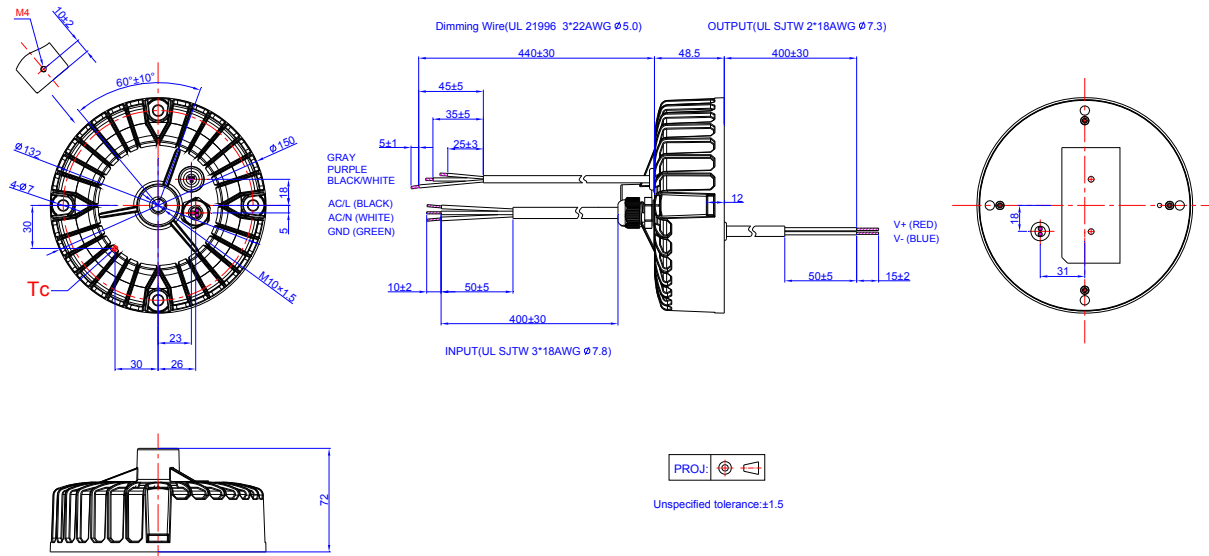

EUR-200SxxxST-0001

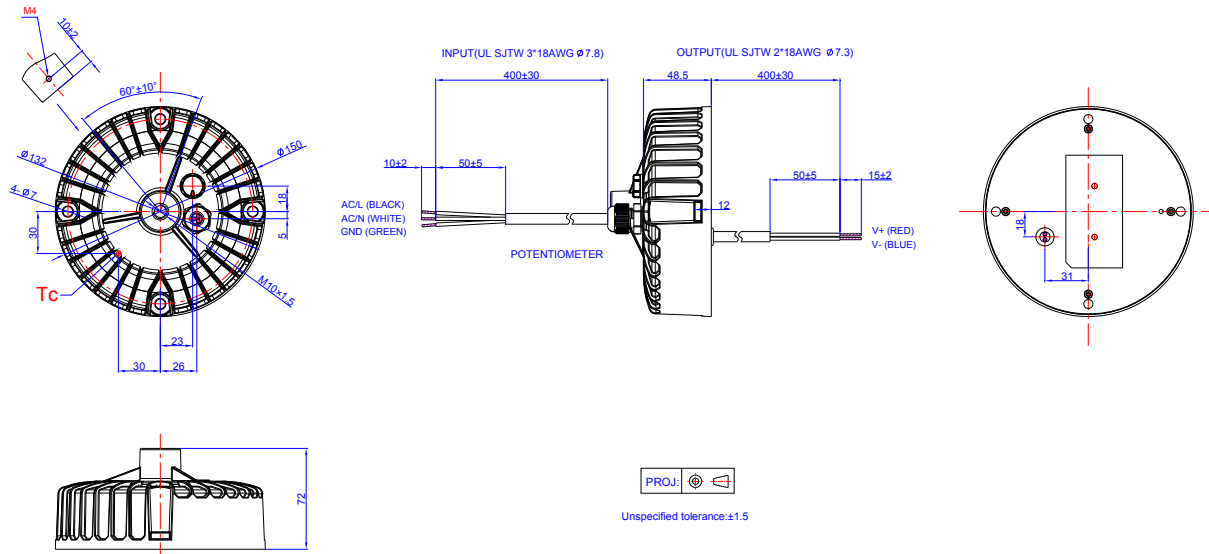

RoHS Compliance

Our products comply with the European Directive 2011/65/EC, calling for the elimination of lead and other hazardous substances from electronic products.

Revision History

Change Date	Rev.	Description of Change		
		Item	From	To
2017-03-02	A	Datasheets Release	/	/
2017-08-12	B	Input Specifications	PF/THD (Note)	Updated
		Output Specifications	Temperature Coefficient of loset	Updated
		Mechanical Outline	/	Updated