

**SuperMOS – TO-252 30V  $BV_{DSS}$ ,  $4m\Omega$   $R_{DS(on)}$ , N-channel MOSFET**

**1. Description**

The KIA50N03BD-ES is N-Channel enhancement MOS Field Effect Transistor. Uses advanced trench technology and design to provide excellent  $R_{DS(ON)}$  with low gate charge. Device is suitable for use in DC-DC conversion, power switch and charging circuit. Standard Product KIA50N03BD-ES is Pb-free.

**2. Features**

- 30V,  $R_{DS(ON)}=4m\Omega$ (Typ.) @ $V_{GS}=10V$   
 $R_{DS(ON)}=6m\Omega$ (Typ.) @ $V_{GS}=4.5V$
- Use trench MOSFET technology
- High density cell design for low  $R_{DS(on)}$
- Material: Halogen free
- Reliable and rugged
- Avalanche Rated
- Low leakage current

**3. Applications**

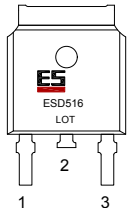
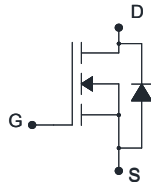
- PWM applications
- Load switch
- Power management in portable/desktop PCs
- DC/DC conversion

**100% UIS TESTED!**

**4. Ordering Information**

Part Number	Package	Marking	Material	Packing	Quantity per reel	Flammability Rating	Reel Size
KIA50N03BD-ES	TO-252	ESD516/LOT	Halogen free	Tape & Reel	2,500 PCS	UL 94V-0	13 inches

**5. Pin Configuration and Functions**

Pin	Function	Outline	Circuit Diagram
1	Gate		
3	Source		
2	Drain		

## 6. Specification

### Absolute Maximum Rating & Thermal Characteristics

Ratings at 25 °C ambient temperature unless otherwise specified.

Parameter		Symbol	Limit	Unit
Drain-Source Voltage		$BV_{DSS}$	30	V
Gate-Source Voltage		$V_{GS}$	$\pm 20$	V
Continuous Drain Current	$T_C=25^\circ\text{C}$	$I_D$	65	A
	$T_C=75^\circ\text{C}$		50	
Maximum Power Dissipation	$T_C=25^\circ\text{C}$	$P_D$	42	W
	$T_C=75^\circ\text{C}$		25	
Pulsed Drain Current <sup>a</sup>		$I_{DM}$	260	A
Avalanche Current, Single Pulsed <sup>b</sup>		$I_{AS}$	32	A
Avalanche Energy, Single Pulsed <sup>b</sup>		$E_{AS}$	153	mJ
Operating Junction Temperature		$T_J$	150	°C
Lead Temperature		$T_L$	260	°C
Storage Temperature Range		$T_{stg}$	-55 to 150	°C

#### Thermal resistance ratings

Single Operation				
Parameter		Symbol	Typical	Unit
Junction-to-Case Thermal Resistance	$t \leq 10 \text{ s}$	$R_{\theta JC}$	3	°C/W

Note:

a: Repetitive rating, pulse width limited by junction temperature,  $t_p=10\mu\text{s}$ , Duty Cycle=1%

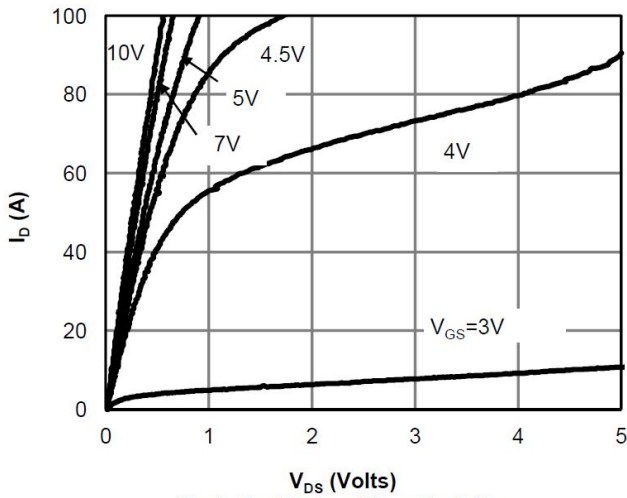
b:  $T_J=25^\circ\text{C}$ ,  $V_{DD}=30\text{V}$ ,  $V_G=10\text{V}$ ,  $L=0.3\text{mH}$ ,  $R_g=25\Omega$

## Electrical Characteristics

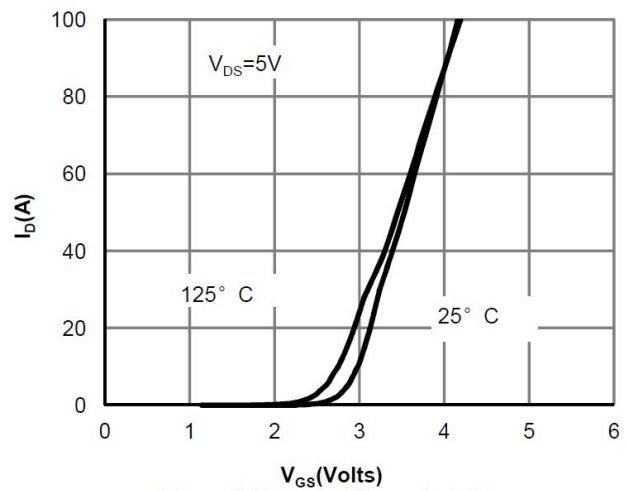
At TA = 25°C unless otherwise specified

Parameter	Symbol	Test Conditions	Min.	Typ.	Max.	Unit
<b>OFF CHARACTERISTICS</b>						
Drain-to-Source Breakdown Voltage	$BV_{DSS}$	$V_{GS}=0V, I_D=250\mu A$	30			V
Zero Gate Voltage Drain Current	$I_{DSS}$	$V_{DS}=30V, V_{GS}=0V$			1.0	$\mu A$
Gate-to-source Leakage Current	$I_{GSS}$	$V_{DS}=0V, V_{GS}=\pm 20V$			$\pm 100$	nA
<b>ON CHARACTERISTICS</b>						
Gate Threshold Voltage	$V_{GS(TH)}$	$V_{GS}=V_{DS}, I_D=250\mu A$	1.0	1.75	2.5	V
Drain-to-source On-resistance	$R_{DS(on)}$	$V_{GS}=10V, I_D=20A$		4.0	6.5	m $\Omega$
		$V_{GS}=4.5V, I_D=20A$		6.0	8.5	
Forward Trans conductance	$g_{FS}$	$V_{DS}=5.0V, I_D=20A$			60	S
<b>CHARGES, CAPACITANCES AND GATE RESISTANCE</b>						
Input Capacitance	$C_{ISS}$	$V_{GS}=0V, f=1MHz, V_{DS}=25V$		1036		pF
Output Capacitance	$C_{OSS}$			444		
Reverse Transfer Capacitance	$C_{RSS}$			62		
Total Gate Charge	$Q_{G(TOT)}$	$V_{GS}=10V, V_{DS}=15V, I_D=20A$		15.8		nC
Gate-to-Source Charge	$Q_{GS}$			3.3		
Gate-to-Drain Charge	$Q_{GD}$			3.6		
<b>SWITCHING CHARACTERISTICS</b>						
Turn-On Delay Time	$t_{d(ON)}$	$V_{GS}=10V, V_{DS}=15V, R_G=0.75\Omega, R_G=1.8\Omega$		5.5		ns
Rise Time	$t_r$			3.3		
Turn-Off Delay Time	$t_{d(OFF)}$			18		
Fall Time	$t_f$			4.3		
<b>BODY DIODE CHARACTERISTICS</b>						
Forward Voltage	$V_{SD}$	$V_{GS}=0V, I_S=1.0A$		0.75	1.5	V

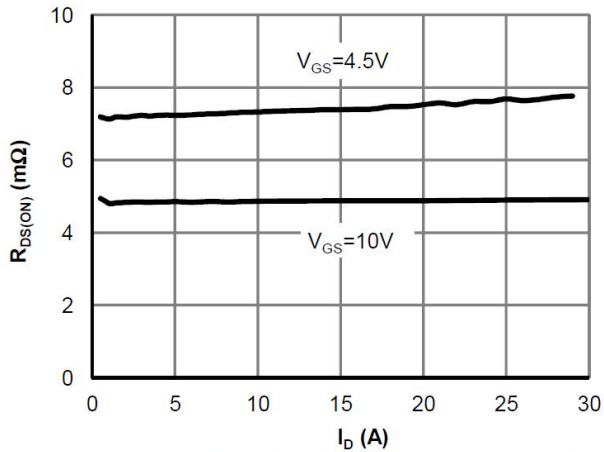
7. Typical Characteristic



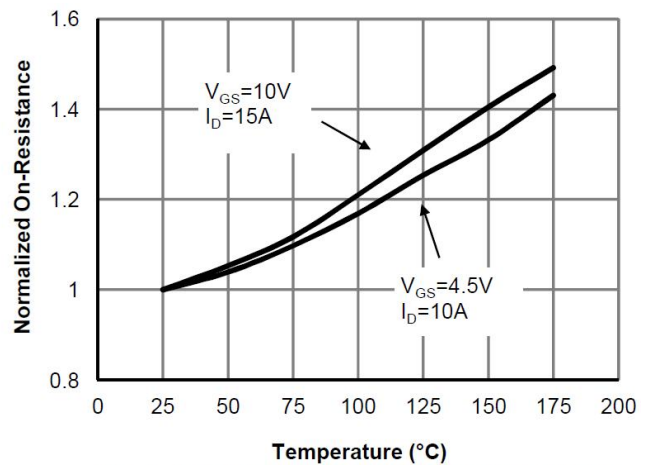
**Fig 1: On-Region Characteristics**



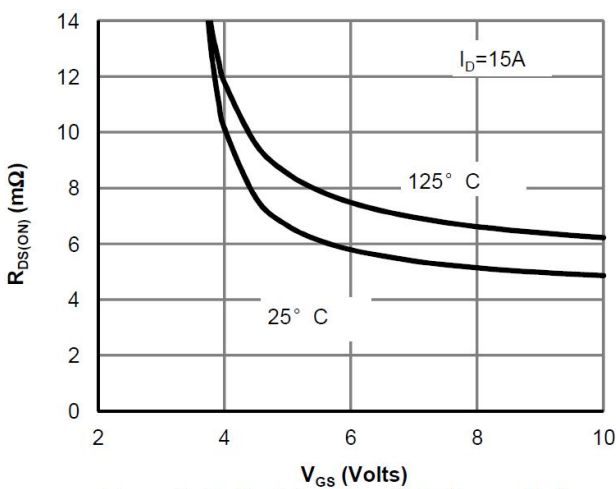
**Figure 2: Transfer Characteristics**



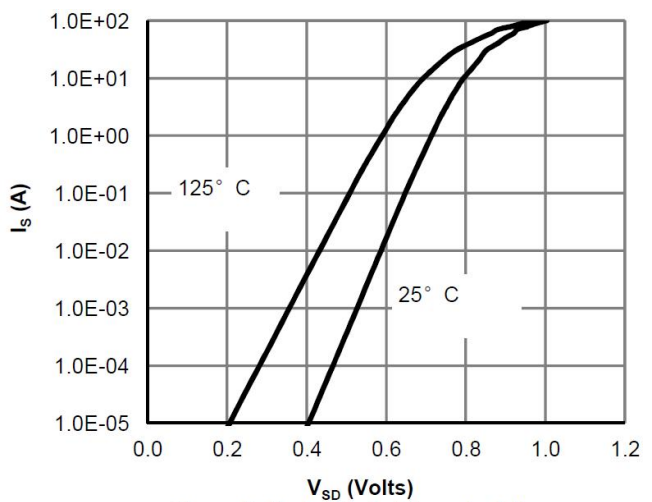
**Figure 3: On-Resistance vs. Drain Current and Gate Voltage**



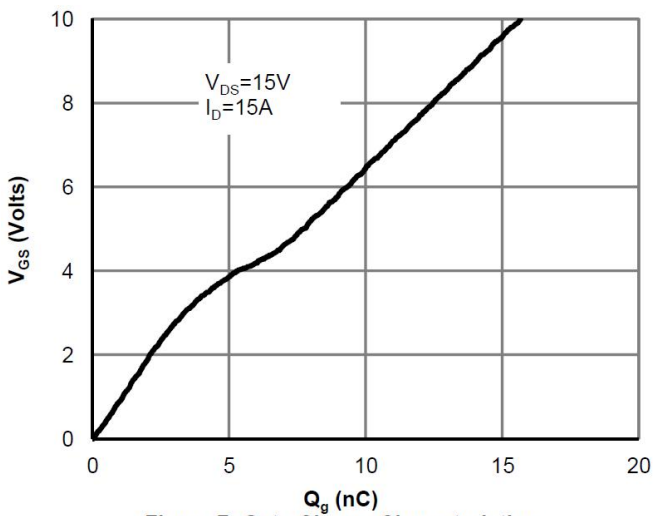
**Figure 4: On-Resistance vs. Junction Temperature**



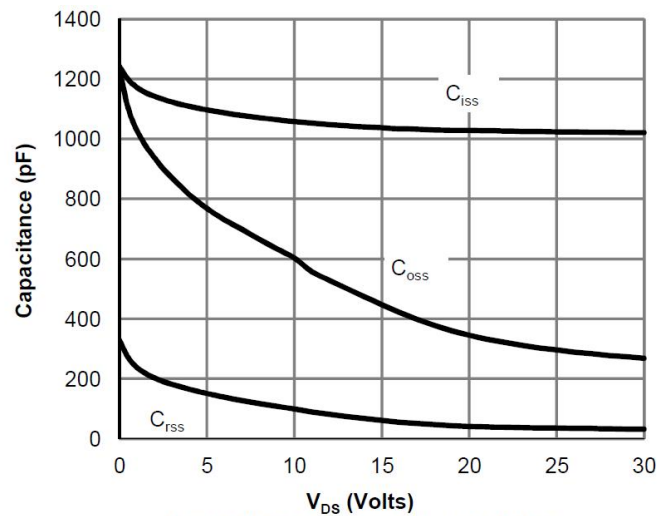
**Figure 5: On-Resistance vs. Gate-Source Voltage**



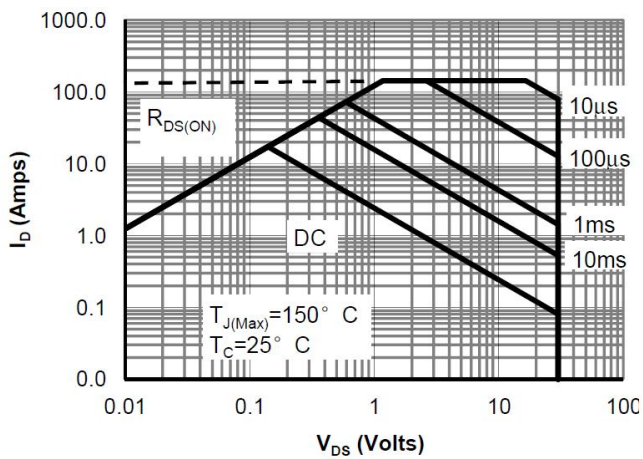
**Figure 6: Body-Diode Characteristics**



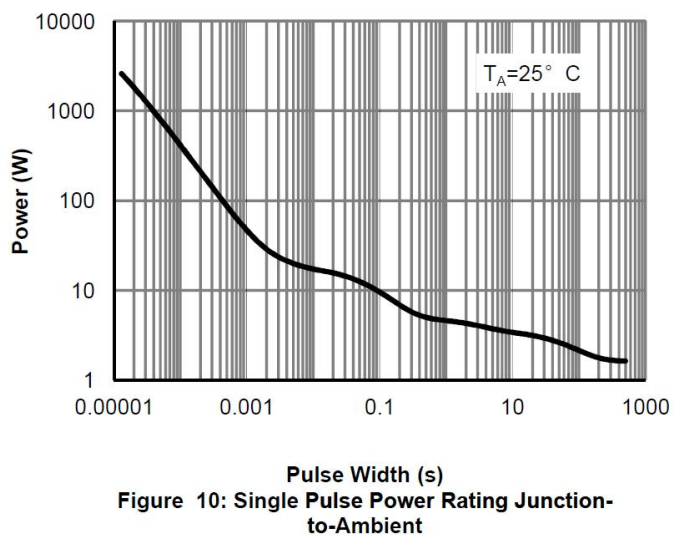
**Figure 7: Gate-Charge Characteristics**



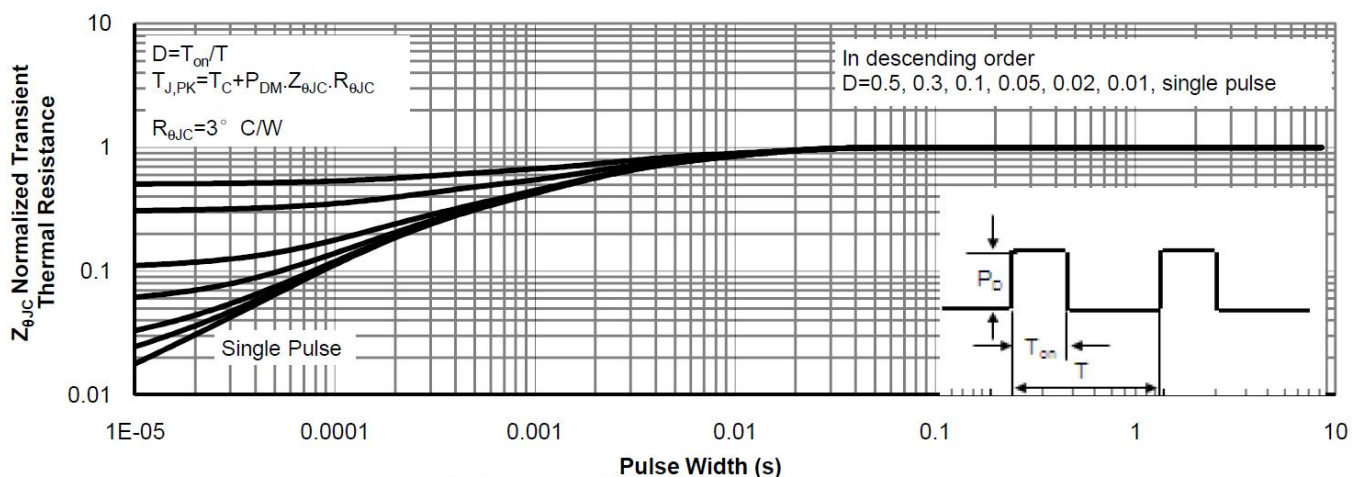
**Figure 8: Capacitance Characteristics**



**Figure 9: Maximum Forward Biased Safe Operating Area**

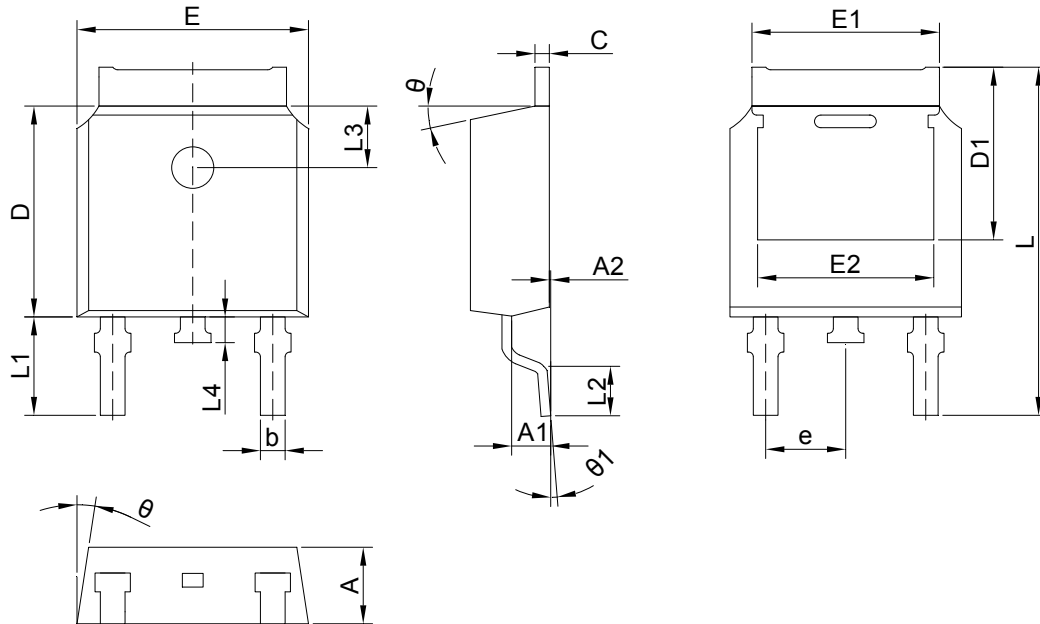


**Figure 10: Single Pulse Power Rating Junction-to-Ambient**



**Figure 11: Normalized Maximum Transient Thermal Impedance**

8. Dimension (TO-252)



COMMON DIMENSIONS CUNITS MEASURE=MILLIMETER							
SYMBOL	MIN	TYP	MAX	SYMBOL	MIN	TYP	MAX
A	2.10	2.30	2.50	E2	4.63	4.83	5.03
A1	0.97	1.07	1.17	L	9.90	10.10	10.30
A2	0.00	-	0.12	L1	2.74	2.94	3.14
b	0.66	0.76	0.86	L2	1.40	1.50	1.70
C	0.45	0.51	0.60	L3	1.65	1.80	1.95
D	5.90	6.10	6.30	L4	0.60	0.80	1.00
D1	5.10	5.30	5.45	e	2.286 BSC		
E	6.40	6.60	6.80	theta	5°	7°	10°
E1	5.10	5.33	5.45	theta1	0°	-	3°

**DISCLAIMER**

ELECSUPER PROVIDES TECHNICAL AND RELIABILITY DATA (INCLUDING DATASHEETS), DESIGN RESOURCES (INCLUDING REFERENCE DESIGNS), APPLICATION OR OTHER DESIGN ADVICE, SAFETY INFORMATION, AND OTHER RESOURCES "AS IS" AND WITH ALL FAULTS, AND DISCLAIMS ALL WARRANTIES, EXPRESS AND IMPLIED, INCLUDING WITHOUT LIMITATION ANY IMPLIED WARRANTIES OF MERCHANTABILITY, FITNESS FOR A PARTICULAR PURPOSE OR NON-INFRINGEMENT OF THIRD PARTY INTELLECTUAL PROPERTY RIGHTS.

These resources are intended for skilled developers designing with ElecSuper products. You are solely responsible for

- (1) selecting the appropriate ElecSuper products for your application;
- (2) designing, validating and testing your application;
- (3) ensuring your application meets applicable standards, and any other safety, security, or other requirements.

These resources are subject to change without notice. ElecSuper grants you permission to use these resources only for development of an application that uses the ElecSuper products described in the resource. Other reproduction and display of these resources are prohibited. No license is granted to any other ElecSuper intellectual property right or to any third party intellectual property right. ElecSuper disclaims responsibility for, and you will fully indemnify ElecSuper and its representatives against, any claims, damages, costs, losses, and liabilities arising out of your use of these resources. ElecSuper's products are provided subject to ElecSuper's Terms of Sale or other applicable terms available either on [www.elecsuper.com](http://www.elecsuper.com) or provided in conjunction with such ElecSuper products. ElecSuper's provision of these resources does not expand or otherwise alter ElecSuper's applicable warranties or warranty disclaimers for ElecSuper products.