

Features

- Fast switching speed
- High conductance

HF

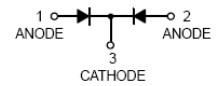

Mechanical Data

- Case: SOT-23
- Molding Compound: UL Flammability Classification Rating 94V-0
- Terminals: Matte tin-plated leads; solderability-per MIL-STD-202, Method 208

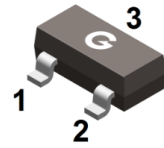

SOT-23

Ordering Information

Part Number	Package	Shipping Quantity	Marking Code
BAV70	SOT-23	3000 pcs / Tape & Reel	A4

Maximum Ratings (@ T_A = 25°C unless otherwise specified)

Parameter	Symbol	Value	Unit
Non-Repetitive Peak Reverse Voltage	V _{RM}	100	V
Peak Repetitive Peak Reverse Voltage	V _{RRM}	75	V
Working Peak Reverse Voltage	V _{RWM}	75	V
DC Blocking Voltage	V _R	75	V
RMS Reverse Voltage	V _{R(RMS)}	53	V
Average Rectified Output Current	I _o	150	mA
Forward continuous Current (Max.)	I _{FM}	300	mA
Peak Forward Surge Current, 1μs Single Half-sine-wave	I _{FSM}	4	A

Thermal Characteristics

Parameter	Symbol	Value	Unit
Power Dissipation	P _D	250	mW
Thermal Resistance Junction-to-Air	R _{θJA}	500	°C/W
Operating Junction Temperature Range	T _J	-65 ~ +150	°C
Storage Temperature Range	T _{STG}	-65 ~ +150	°C

Electrical Characteristics (@ $T_A = 25^\circ\text{C}$ unless otherwise specified)

Parameter	Symbol	Test Condition	Min.	Typ.	Max.	Unit
Reverse Breakdown Voltage	$V_{(BR)R}$	$I_R = 2.5\mu\text{A}$	75	-	-	V
Forward Voltage	V_F	$I_F = 1\text{mA}$	-	-	0.715	V
		$I_F = 10\text{mA}$	-	-	0.855	V
		$I_F = 50\text{mA}$	-	-	1.000	V
		$I_F = 150\text{mA}$	-	-	1.250	V
Maximum Peak Reverse Current	I_R	$V_R = 20\text{V}$	-	-	25	nA
		$V_R = 75\text{V}$	-	-	2.5	μA
Total Capacitance	C_J	$V_R = 0\text{V}, f = 1.0\text{MHz}$	-	-	2	pF
Reverse Recovery Time	t_{rr}	$I_F = I_R = 10\text{mA}$ $I_{rr} = 0.1 \times I_R, R_L = 100\Omega$	-	-	4	ns

Ratings and Characteristics Curves (@ $T_A = 25^\circ\text{C}$ unless otherwise specified)

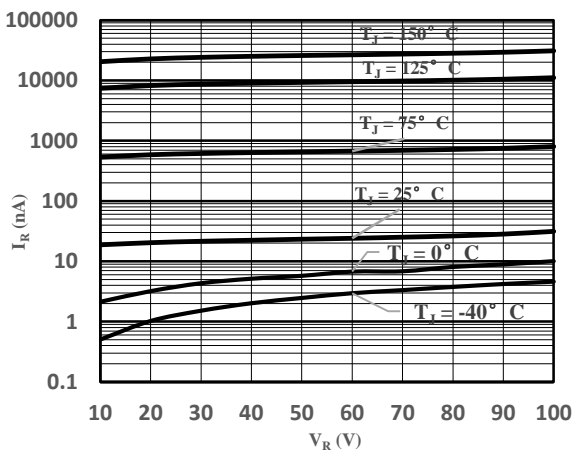

Fig 1 Typical Reverse Characteristic

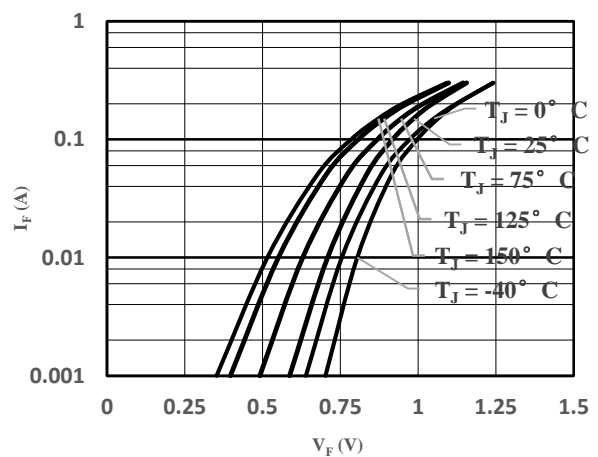

Fig 2 Typical Forward Characteristics

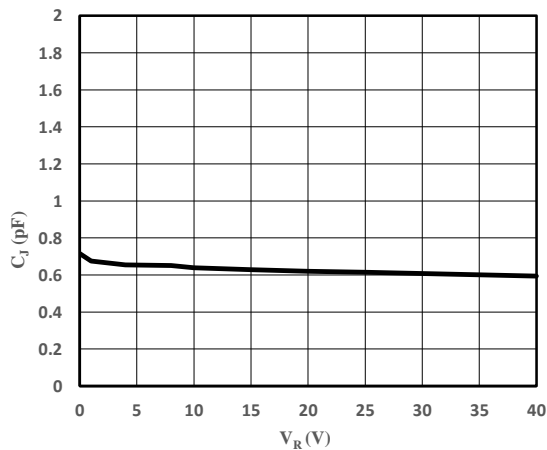

Fig 3 Capacitance vs. Reverse Voltage

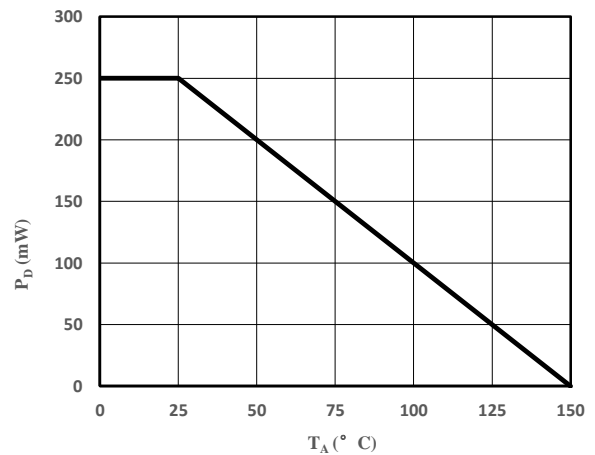
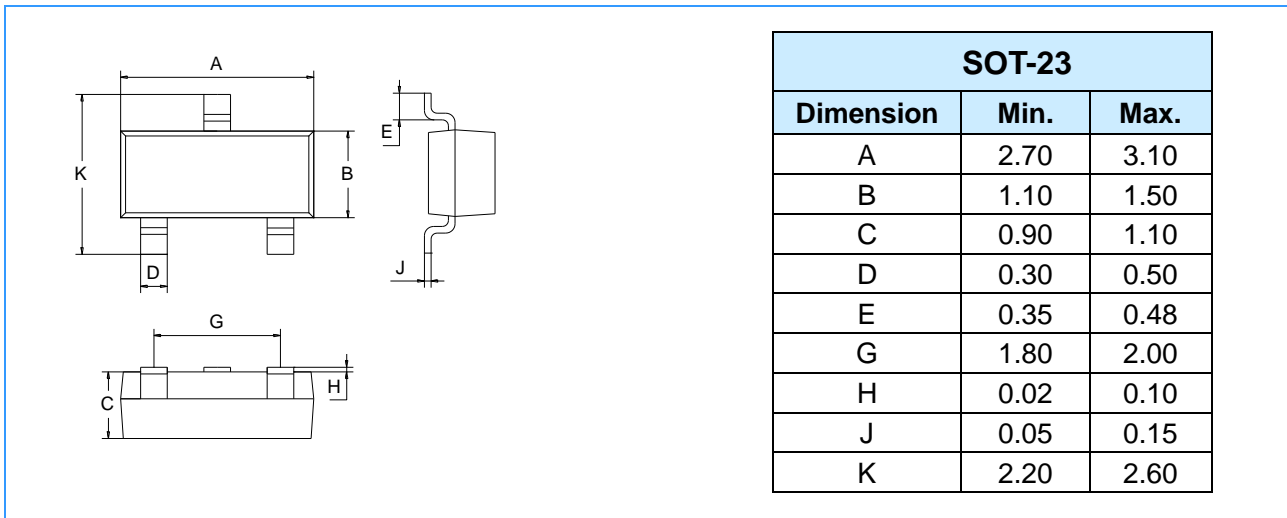
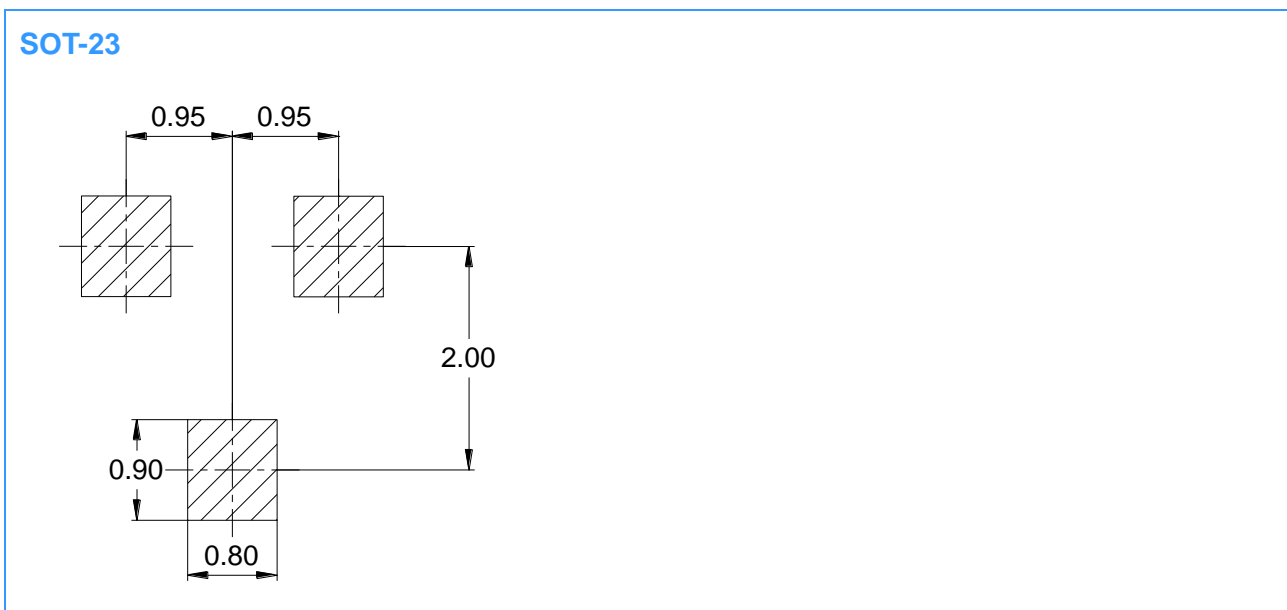

Fig 4 Power Derating Curve

Package Outline Dimensions (Unit: mm)



Package Outline Dimensions (Unit: mm)



Important Notice

Changzhou Galaxy Century Microelectronics (GME) reserves the right to make changes without further notice to any product information (copyrighted) herein to make corrections, modifications, improvements, or other changes. GME does not assume any liability arising out of the application or use of any product described herein; neither does it convey any license under its patent rights, nor the rights of others.