

### 1 外形尺寸 Shape and Dimensions

- 尺寸: 见图 1 和表 1
- PCB 焊盘: 见图 2 和表 1
- Dimensions: See Fig.1 and Table 1.
- Recommended PCB pattern for reflow soldering: See Fig.2 and Table 1



图 1 Fig.1



图 2 Fig.2

表 1 (Table 1)

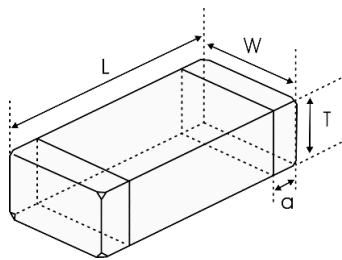
单位 unit: inch[mm]

类别 Type	L	W	T	a	A	B	C
0603 [1608]	0.063±0.006 [1.6±0.15]	0.031±0.006 [0.8±0.15]	0.031±0.006 [0.8±0.15]	0.012±0.008 [0.3±0.2]	[0.6-0.8]	[0.6-0.7]	[0.6-0.8]

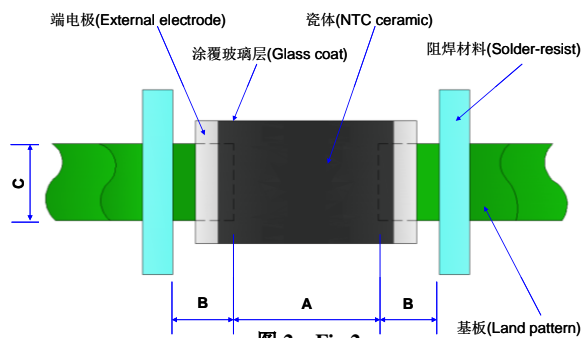
### 2 电气特性 Electrical Characteristics

型号 Part No	电阻值 Resistance (25°C) (kΩ)	B 常数 B Constant (25/50°C) (K)	B 常数 B Constant (25/85°C) (K)	允许工作电流 Permissible Operating Current (25°C) (mA)	耗散系数 Dissipation Factor (mW/°C)	热时间常数 Thermal Time Constant (s)	额定功率 Rated Electric Power(25°C) (mW)	工作温度 Operating ambient temperature (°C)
KNTC0603/10KJ3950	10±5%	3950±1%	3987 ref.	0.31	1.0	<5	100	-40~+125

注 Notes: 在 25°C 静止空气中, 以未贴装的独立单元测试。When measured at 25 °C in still air, as a single unit without mounting.

### 3 检验和测试程序

#### ▪ 测试条件

如无特别规定，检验和测试的标准大气环境条件如下：

- a. 环境温度：20±15℃；
- b. 相对湿度：65±20%；
- c. 气压：86 kPa~106 kPa

如果对测试结果有异议，则在下述条件下测试：

- a. 环境温度：25±2℃；
- b. 相对湿度：65±5%
- c. 气压：86kPa ~ 106kPa

#### ▪ 检查设备

外观检查：20 倍放大镜；

阻值检查：热敏电阻测试仪

### 3 Test and Measurement Procedures

#### ▪ Test Conditions

Unless otherwise specified, the standard atmospheric conditions for measurement/test as:

- a. Ambient Temperature: 20±15℃
- b. Relative Humidity: 65±20%
- c. Air Pressure: 86kPa to 106kPa

If any doubt on the results, measurements/tests should be made within the following limits:

- a. Ambient Temperature: 25±2℃
- b. Relative Humidity: 65±5%
- c. Air Pressure: 86kPa to 106kPa

#### ▪ Inspection Equipment

Visual Examination: 20× magnifier

Resistance value test: Thermistor resistance tester

### 4 电性测试 Electrical Test

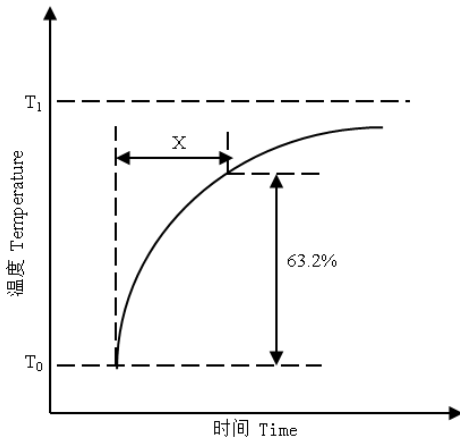
序号 No.	项目 Items	测试方法及备注 Test Methods and Remarks
1	25℃零功率电阻值 Nominal Zero-Power Resistance at 25℃(R25)	环境温度 Ambient temperature: 25±0.05℃ 测试功率 Measuring electric power: ≤0.1mW
2	B 值常数 Nominal B Constant	分别在环境温度 25±0.05℃, 50±0.05℃或 85±0.05℃下测量电阻值。 Measure the resistance at the ambient temperature of 25±0.05℃, 50±0.05℃ or 85±0.05℃. $B(25-50℃) = \frac{\ln R_{25} - \ln R_{50}}{1/T_{25} - 1/T_{50}}$ $B(25-85℃) = \frac{\ln R_{25} - \ln R_{85}}{1/T_{25} - 1/T_{85}}$ T: 绝对温度 (K) Absolute temperature (K)
3	热时间常数 Thermal Time Constant	在零功率条件下，当热敏电阻的环境温度发生急剧变化时，热敏电阻元件产生最初温度 T0 与最终温度 T1 两者温度差的 63.2%的温度变化所需要的时间，通常以秒(S)表示。 The total time for the temperature of the thermistor to change by 63.2% of the difference from ambient temperature T <sub>0</sub> (°C) to T <sub>1</sub> (°C) by the drastic change of the power applied to thermistor from Non-zero Power to Zero-Power state, normally expressed in second(S). 

序号 No.	项目 Items	测试方法及备注 Test Methods and Remarks
4	耗散系数 Dissipation Factor	在一定环境温度下，NTC 热敏电阻通过自身发热使其温度升高 1℃时所需要的功率，通常以 mW/℃表示。可由下面公式计算： The required power which makes the NTC thermistor body temperature raise 1℃ through self-heated, normally expressed in milliwatts per degree Celsius (mW/℃). It can be calculated by the following formula: $\delta = \frac{W}{T-T_0}$
5	额定功率 Rated Power	在环境温度 25℃下因自身发热使表面温度升高 100℃所需要的功率。 The necessary electric power makes thermistor's temperature rise 100℃ by self-heating at ambient temperature 25℃.
6	允许工作电流 Permissible operating current	在静止空气中通过自身发热使其升温为 1℃的电流。 The current that keep body temperature of chip NTC on the PC board in still air rising 1℃ by self-heating.

注 Notes: 在 25℃的静止空气中给 NTC 热敏电阻施加 100mW 的额定功率，NTC 热敏电阻会升温 100℃左右。但太快的升温速度可能会导致 NTC 热敏电阻意外失效，因此请不要短时间内给其施加大于 10mW 的功率（10mW 的功率会让 NTC 热敏电阻升温 10℃左右）。建议电流小于允许工作电流值的 1/10 以防止 NTC 热敏电阻自热。功率与工作温度的关系如下图所示：

When Rated Electric Power(100mW) is applied to NTC thermistor at 25℃ in still air, temperature rise of the NTC thermistor is about 100℃. However, too rapid temperature rise may cause unexpected failures to the NTC thermistor, please do not apply more than 10mW of electric power to it in short time (10mW of power will increase the temperature of the NTC thermistor by about 10℃). The current less than 1/10 of the Permissive Operating Current value is recommended in order to prevent self-heating of the NTC thermistor. The relationship between electric power and operating temperature is showed as below:

功率与温度关系图  
Electric power & temperature Curve

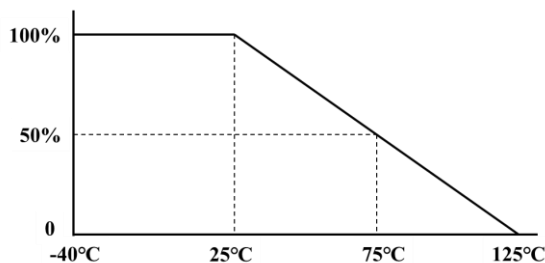

## 5 信赖性试验 Reliability Test

项目 Items	测试标准 Standard	测试方法及备注 Test Methods and Remarks	要求 Requirements										
端头附着力 Terminal Strength	IEC 60068-2-21	<p>将晶片焊接在测试基板上（如右图所示的环氧玻璃布板），按箭头所示方向施加作用力； Solder the chip to the testing jig (glass epoxy board shown in the right) using eutectic solder. Then apply a force in the direction of the arrow.</p> <table border="1" style="margin-left: auto; margin-right: auto;"> <thead> <tr> <th>尺寸 Size</th> <th>F</th> <th>保持时间 Duration</th> </tr> </thead> <tbody> <tr> <td>0201</td> <td>2N</td> <td rowspan="3" style="text-align: center;">10±1s</td> </tr> <tr> <td>0402, 0603</td> <td>5N</td> </tr> <tr> <td>0805</td> <td>10N</td> </tr> </tbody> </table>	尺寸 Size	F	保持时间 Duration	0201	2N	10±1s	0402, 0603	5N	0805	10N	<p>端电极无脱落且瓷体无损伤。 No removal or split of the termination or other defects shall occur.</p>
尺寸 Size	F	保持时间 Duration											
0201	2N	10±1s											
0402, 0603	5N												
0805	10N												

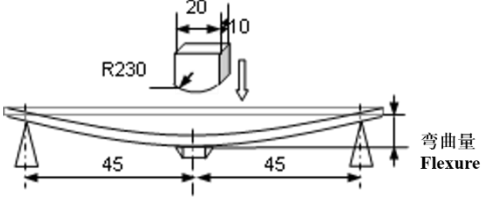
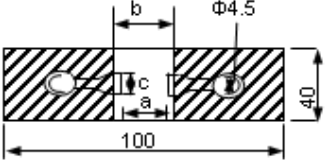
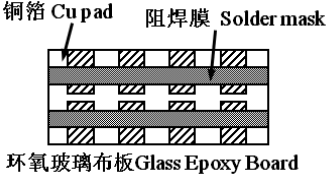
<p>抗弯强度 Resistance to Flexure</p>	<p>IEC 60068-2-21</p>	<p>将晶片焊接在测试基板上（如右图所示的环氧玻璃布板），按下图箭头所示方向施加作用力； Solder the chip to the test jig (glass epoxy board shown in the right) using a eutectic solder. Then apply a force in the direction shown as follow;</p>  <table border="1" data-bbox="448 573 1086 790"> <thead> <tr> <th>尺寸 Size</th> <th>弯曲变形量 Flexure</th> <th>施压速度 Pressurizing Speed</th> <th>保持时间 Duration</th> </tr> </thead> <tbody> <tr> <td>0201,</td> <td>1mm</td> <td rowspan="2">&lt;0.5mm/s</td> <td rowspan="2">10±1s</td> </tr> <tr> <td>0402, 0603, 0805</td> <td>2mm</td> </tr> </tbody> </table>	尺寸 Size	弯曲变形量 Flexure	施压速度 Pressurizing Speed	保持时间 Duration	0201,	1mm	<0.5mm/s	10±1s	0402, 0603, 0805	2mm	<p>① 无外观损伤。 No visible damage.</p> <p>② <math> \Delta R25/R25  \leq 2\%</math></p> <p>单位 unit: mm</p> <table border="1" data-bbox="1155 327 1517 533"> <thead> <tr> <th>类型 Type</th> <th>a</th> <th>b</th> <th>c</th> </tr> </thead> <tbody> <tr> <td>0201</td> <td>0.25</td> <td>0.3</td> <td>0.3</td> </tr> <tr> <td>0402</td> <td>0.4</td> <td>1.5</td> <td>0.5</td> </tr> <tr> <td>0603</td> <td>1.0</td> <td>3.0</td> <td>1.2</td> </tr> <tr> <td>0805</td> <td>1.2</td> <td>4.0</td> <td>1.65</td> </tr> </tbody> </table> 	类型 Type	a	b	c	0201	0.25	0.3	0.3	0402	0.4	1.5	0.5	0603	1.0	3.0	1.2	0805	1.2	4.0	1.65
尺寸 Size	弯曲变形量 Flexure	施压速度 Pressurizing Speed	保持时间 Duration																														
0201,	1mm	<0.5mm/s	10±1s																														
0402, 0603, 0805	2mm																																
类型 Type	a	b	c																														
0201	0.25	0.3	0.3																														
0402	0.4	1.5	0.5																														
0603	1.0	3.0	1.2																														
0805	1.2	4.0	1.65																														
<p>振动 Vibration</p>	<p>IEC 60068-2-80</p>	<p>① 将晶片焊接在测试基板上（如右图所示的环氧玻璃布板）； Solder the chip to the testing jig (glass epoxy board shown in the left) using eutectic solder.</p> <p>② 晶片以全振幅为 1.5mm 进行振动，频率范围为 10Hz ~ 55 Hz； The chip shall be subjected to a simple harmonic motion having total amplitude of 1.5mm, the frequency being varied uniformly between the approximate limits of 10 and 55 Hz.</p> <p>③ 振动频率按 10Hz→55Hz→10Hz 循环，周期为 1 分钟，在空间三个互相垂直的方向上各振动 2 小时（共 6 小时）。 The frequency ranges from 10 to 55 Hz and return to 10 Hz shall be traversed in approximately 1 minute. This motion shall be applied for a period of 2 hours in each 3 mutually perpendicular directions (total of 6 hours).</p>	<p>无外观损伤。 No visible damage.</p> 																														
<p>坠落 Dropping</p>	<p>IEC 60068-2-32</p>	<p>从 1m 的高度让晶片自由坠落至水泥地面 10 次。 Drop a chip 10 times on a concrete floor from a height of 1 meter.</p>	<p>无外观损伤。 No visible damage.</p>																														
<p>可焊性 Solderability</p>	<p>IEC 60068-2-58</p>	<p>① 焊接温度 Solder temperature: 245±5℃.</p> <p>② 浸渍时间 Duration: 3±0.3s.</p> <p>③ 焊锡成分 Solder: 96.5wt% Sn/3.0wt% Ag/0.5wt% Cu</p> <p>④ 助焊剂 Flux: （重量比）25%松香和 75%酒精 25% Rosin and 75% ethanol in weight.</p>	<p>① 无外观损伤； No visible damage.</p> <p>② 元件端电极的焊锡覆盖率不小于 95%。 Wetting shall exceed 95% coverage.</p>																														
<p>耐焊性 Resistance to Soldering Heat</p>	<p>IEC 60068-2-58</p>	<p>① 焊接温度 Solder temperature: 260±5℃.</p> <p>② 浸渍时间 Duration: 10±1s.</p> <p>③ 焊锡成分 Solder: 96.5wt% Sn/3.0wt% Ag/0.5wt% Cu .</p> <p>④ 助焊剂 Flux: （重量比）25%松香和 75%酒精 25% Rosin and 75% ethanol in weight.</p> <p>⑤ 试验后标准条件下放置 1~2 小时后测量。 The chip shall be stabilized at normal condition for 1~2 hours before measuring.</p>	<p>① 无外观损伤； No visible damage.</p> <p>② <math> \Delta R25/R25  \leq 2\%</math></p> <p>③ <math> \Delta B/B  \leq 1\%</math></p>																														

温度周期 Temperature cycling	IEC 60068-2-14	<p>① 无负载于下表所示的环境条件下重复 5 次。 5 cycles of following sequence without loading.</p> <table border="1"> <thead> <tr> <th>步骤 Step</th> <th>温度 Temperature</th> <th>时间 Time</th> </tr> </thead> <tbody> <tr> <td>1</td> <td>-40±5℃</td> <td>30±3min</td> </tr> <tr> <td>2</td> <td>25±2℃</td> <td>5±3min</td> </tr> <tr> <td>3</td> <td>125±2℃</td> <td>30±3min</td> </tr> <tr> <td>4</td> <td>25±2℃</td> <td>5±3min</td> </tr> </tbody> </table> <p>② 试验后标准条件下放置 1~2 小时后测量。 The chip shall be stabilized at normal condition for 1~2 hours before measuring.</p>	步骤 Step	温度 Temperature	时间 Time	1	-40±5℃	30±3min	2	25±2℃	5±3min	3	125±2℃	30±3min	4	25±2℃	5±3min	<p>① 无外观损伤; No visible damage.</p> <p>②   <math>\Delta R_{25}/R_{25}</math>   ≤2%</p> <p>③   <math>\Delta B/B</math>   ≤1%</p>
步骤 Step	温度 Temperature	时间 Time																
1	-40±5℃	30±3min																
2	25±2℃	5±3min																
3	125±2℃	30±3min																
4	25±2℃	5±3min																
高温存放 Resistance to dry heat	IEC 60068-2-2	<p>① 在 125±5℃空气中, 无负载放置 1000±24 小时。 125±5℃ in air, for 1000±24 hours without loading.</p> <p>② 试验后标准条件下放置 1~2 小时后测量。 The chip shall be stabilized at normal condition for 1~2 hours before measuring.</p>	<p>① 无外观损伤; No visible damage.</p> <p>②   <math>\Delta R_{25}/R_{25}</math>   ≤2%</p> <p>③   <math>\Delta B/B</math>   ≤1%</p>															
低温存放 Resistance to cold	IEC 60068-2-1	<p>① 在 -40±3℃空气中, 无负载放置 1000±24 小时。 -40±3℃ in air, for 1000±24 hours without loading.</p> <p>② 试验后标准条件下放置 1~2 小时后测量。 The chip shall be stabilized at normal condition for 1~2 hours before measuring.</p>	<p>① 无外观损伤; No visible damage.</p> <p>②   <math>\Delta R_{25}/R_{25}</math>   ≤2%</p> <p>③   <math>\Delta B/B</math>   ≤1%</p>															
湿热存放 Resistance to damp heat	IEC 60068-2-78	<p>① 在 60±2℃, 相对湿度 90~95%空气中, 无负载放置 1000±24 小时。 60±2℃, 90~95%RH in air, for 1000±24 hours without loading.</p> <p>② 试验后标准条件下放置 1~2 小时后测量。 The chip shall be stabilized at normal condition for 1~2 hours before measuring.</p>	<p>① 无外观损伤; No visible damage.</p> <p>②   <math>\Delta R_{25}/R_{25}</math>   ≤2%</p> <p>③   <math>\Delta B/B</math>   ≤1%</p>															
高温负荷 Resistance to high temperature load	IEC 60539-1 5.25.4	<p>① 在 85±2℃空气中, 施加允许工作电流 1000±48 小时。 85±2℃ in air with permissive operating current for 1000±48 hours</p> <p>② 试验后标准条件下放置 1~2 小时后测量。 The chip shall be stabilized at normal condition for 1~2 hours before measuring.</p>	<p>① 无外观损伤; No visible damage.</p> <p>②   <math>\Delta R_{25}/R_{25}</math>   ≤2%</p> <p>③   <math>\Delta B/B</math>   ≤1%</p>															

## 6 编带 Taping

类型 Type	0201	0402	0603	0805
编带厚度 Tape thickness(mm)	0.5±0.15	0.5±0.15	0.8±0.15	0.85±0.2
编带材质 Tape material	纸带 Paper Tape			
每盘数量 Quantity per Reel	15K	10K	4K	4K

(1) 编带图 Taping Drawings

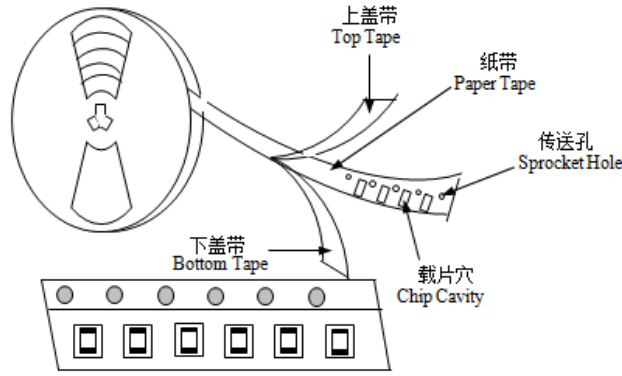

(2) 纸带尺寸 Paper Tape Dimensions (单位 Unit: mm)

0201 系列 0201 series

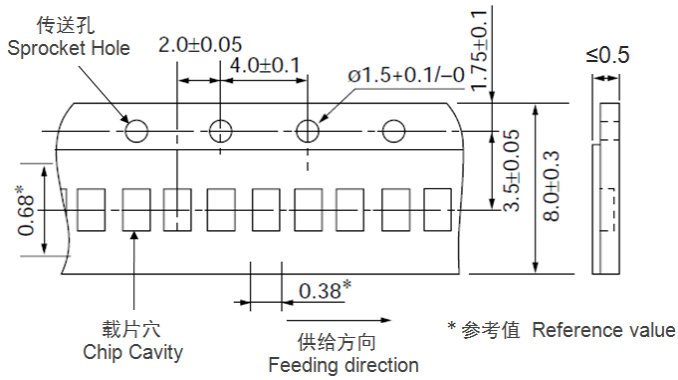

0402 系列 0402 series

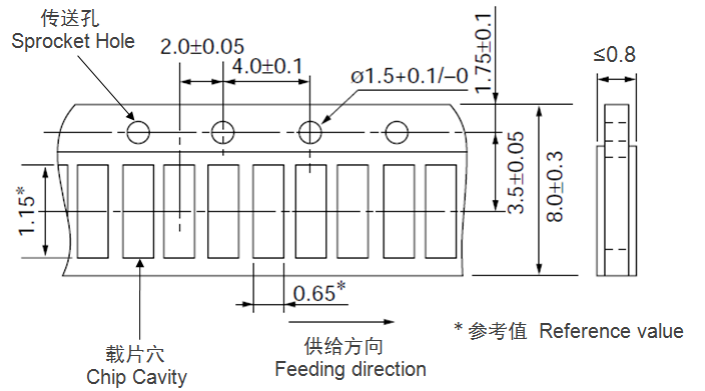

0603 系列 0603 series

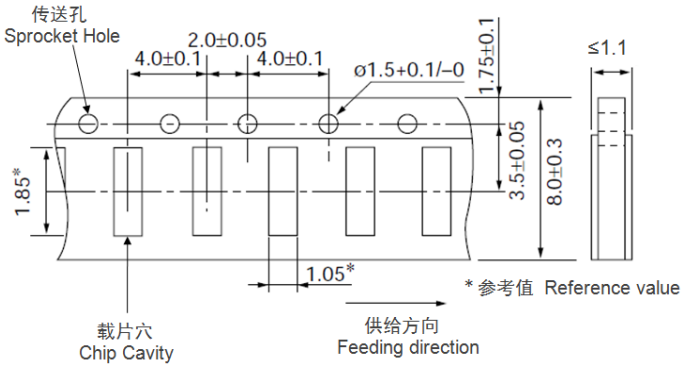

0805 系列 0805 series

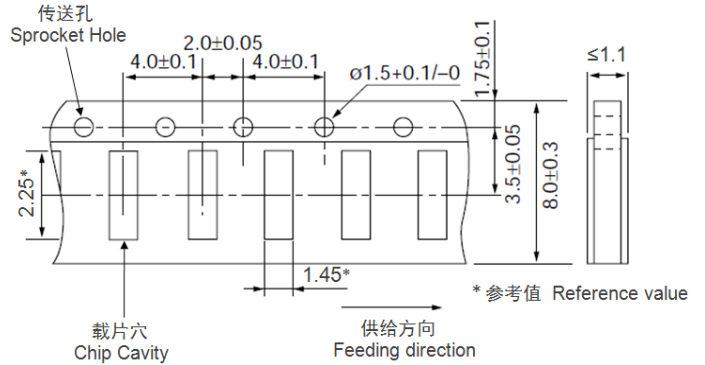

(3) 卷盘尺寸 Reel Dimensions (单位 Unit: mm)

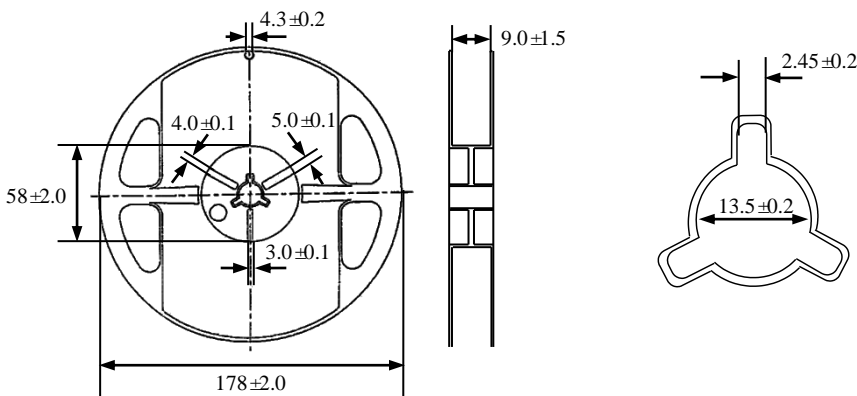

## 7 储存

### • 储存条件

- 储存温度:  $-10^{\circ}\text{C} \sim 40^{\circ}\text{C}$
- 相对湿度:  $\leq 75\% \text{RH}$
- 避免接触粉尘、腐蚀性气氛和阳光

### • 储存期限: 产品交付后 6 个月

## 8 注意事项

### • 系列热敏电阻不可在以下条件下工作或储存:

- 腐蚀性气体或还原性气体  
(氯气、硫化氢气体、氨气、硫酸气体、一氧化氮等)。
- 挥发性或易燃性气体
- 多尘条件
- 高压或低压条件
- 潮湿场所
- 存在盐水、油、化学液体或有机溶剂的场所
- 强烈振动
- 存在类似有害条件的其他场所

### • 系列热敏电阻的陶瓷属于易碎材料, 使用时不可施加过大压力或冲击。

### • 系列热敏电阻不可在超过目录规定的温度范围情况下工作。

### • 应选择适当的贴装位置, 使电路板屈曲或弯折时施加在晶片上的应力最小。相关建议如下:

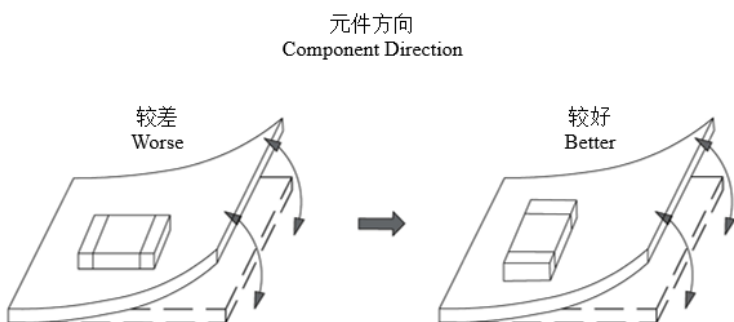

将产品沿应力作用方向水平放置。  
Locate this product horizontal to the direction in which stress acts.

## 7 Storage

### • Storage Conditions

- Storage Temperature:  $-10^{\circ}\text{C} \sim 40^{\circ}\text{C}$
- Relative Humidity:  $\leq 75\% \text{RH}$
- Keep away from corrosive atmosphere and sunlight.

### • Period of Storage: 6 Months after delivery

## 8 Notes & Warnings

### • The series thermistors shall not be operated and stored under the following environmental condition:

- Corrosive or deoxidized atmospheres  
(such as chlorine, sulfurated hydrogen, ammonia, sulfuric acid, nitric oxide and so on)
- Volatile or inflammable atmospheres
- Dusty condition
- Excessively high or low pressure condition
- Humid site
- Places with brine, oil, chemical liquid or organic solvent
- Intense vibration
- Places with analogously deleterious conditions

### • The ceramic body of the series thermistors is fragile, no excessive pressure or impact shall be exerted on it.

### • The series thermistors shall not be operated beyond the specified "Operating Temperature Range" in the catalog.

### • Choose a proper mounting position that minimize the stress imposed on the chip during flexing or bending of the board. The recommendations are shown in the figure below:

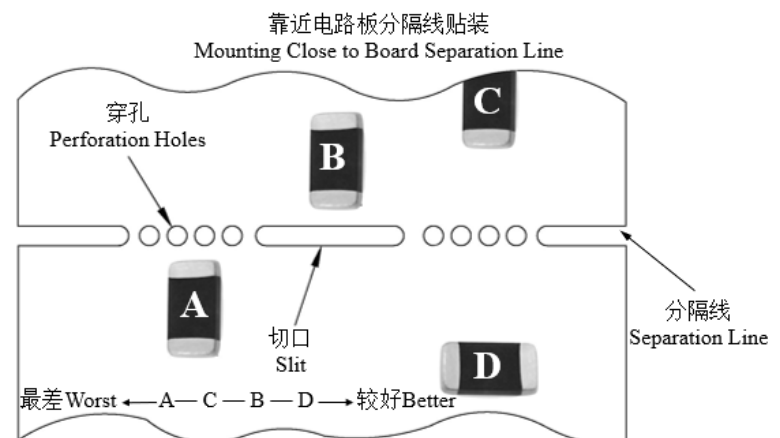

使本产品放在印刷电路板上靠近切口, 而不是靠近穿孔。  
Put this product on the PC Board near the Slit, not near the Perforation Holes.

使本产品远离印刷电路板上的分隔线位置。  
Keep this product on the PC Board away from the Separation Line.

## 9 建议焊接条件

- 回流焊
- 温升 1~2°C/sec.
- 预热: 150~170°C/90±30 sec.  
预热不足可能会导致陶瓷体破裂。曲线上预热温度与最高温度之间的差值应为 100°C。
- 大于 240°C 时间: 20~40sec
- 峰值温度: 最高 260°C/10 sec.
- 焊膏: 96.5wt%Sn/3.0wt%Ag/0.5wt%Cu
- 助焊剂: 焊接时应使用松香助焊剂。  
若使用强酸性助焊剂(卤化物含量超过 0.1wt%)或水溶性助焊剂(非树脂型助焊剂, 包括水洗型助焊剂和非水洗型助焊剂), 则可能造成产品特性和可靠性方面问题。
- 回流焊: 最多 2 次。  
两次焊接峰值温度累积时间必须控制在 30 秒内。
- 冷却: 在空气逐渐冷却。不建议将元件浸泡溶剂或使用其他方法来快速冷却。
- 不符合焊接条件可能会造成金属分解或外部电极上的焊料湿润程度变差。

## 9 Recommended Soldering Technologies

- **Re-flowing Profile**
- 1~2°C/sec. Ramp
- Pre-heating: 150~170°C/90±30 sec.  
Insufficient preheating may cause a crack on the ceramic body. The difference between preheating temperature and the highest temperature in the profile shall be 100°C.
- Time above 240°C: 20~40 sec.
- Peak temperature: 260°C Max./10 sec.
- Solder paste: 96.5wt%Sn/3.0wt%Ag/0.5wt%Cu
- Flux: Use rosin type flux in the soldering process.  
If strong acidic flux(with halide content exceeding 0.1wt%) or water-soluble flux(non-rosin type flux including wash-type flux and non-wash-type flux) is used, some problems might be caused in the product characteristics and reliability.
- Max.2 times for re-flowing.  
In case of repeated soldering, the total accumulated soldering time at peak temperature is within 30sec (Including the first time and second time).
- Cooling: Gradual cooling in air. Rapid cooling by dipping in solvent or by other means is not recommended.
- Excessive soldering conditions may cause dissolution of metallization or deterioration of solder-wetting on the external electrode.

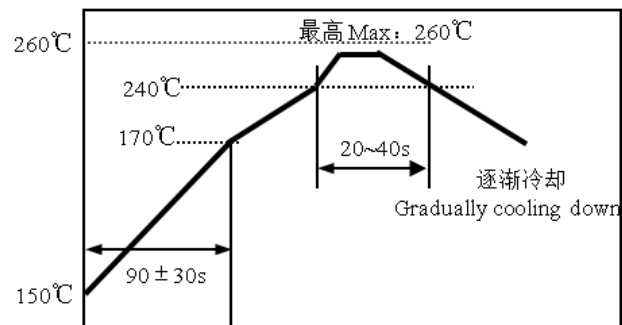

- 手工焊
- 烙铁功率: 最大 20W
- 预热: 150°C/60sec.
- 烙铁头温度: 最高 280°C
- 焊接时间: 最多 3sec.
- 焊膏: 96.5wt%Sn/3.0wt%Ag/0.5wt%Cu
- 手工焊: 最多 1 次

[注: 不要使烙铁头接触到端头]

- **Iron Soldering Profile**
- Iron soldering power: Max.20W
- Pre-heating: 150°C/60sec.
- Soldering Tip temperature: 280°C Max.
- Soldering time: 3 sec Max.
- Solder paste: 96.5wt%Sn/3.0wt%Ag/0.5wt%Cu
- Max.1 times for iron soldering

[Note: Take care not to apply the tip of the soldering iron to the terminal electrodes.]



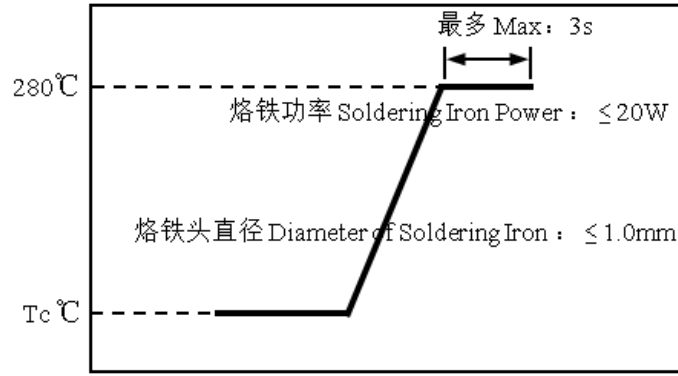

• **焊膏的印刷条件**

- 焊膏用量至关重要。下表列出了焊角的标准高度。
- 过多焊料会造成机械应力，导致断裂、机械损坏和/或电子元件损坏。

• **Printing Conditions of Solder Paste**

- The amount of solder is critical . Standard height of fillet is shown in the table below.
- Too much solder may cause mechanical stress , resulting in cracking , mechanical and / or electronic damage.

参考：最佳焊接用量 Reference: Optimum Solder Amount

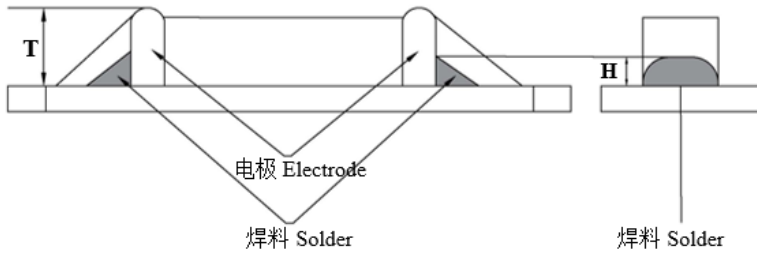

类型 Type	焊膏厚度 Solder Paste Thickness	H
0201	100 $\mu$ m	$1/3T \leq H \leq T$
0402	150 $\mu$ m	$1/3T \leq H \leq T$
0603 , 0805	200 $\mu$ m	$0.2mm \leq H \leq T$

• **焊接完成后**

- 焊接完成后要清除助焊剂时，请遵循以下几点，以免造成特性退化或导致外部电极质量变化。
- 1) 进行超声清洗时，请防止安装部分与基板发生共振。
  - 2) 在使用了非水洗型助焊剂时，请勿清洗产品。

• **After Soldering**

- For removing the flux after soldering, observe the following points in order to avoid deterioration of the characteristics or any change of the external electrodes quality.
- 1) Please keep mounted parts and a substrate from an occurrence of resonance in ultrasonic cleaning.
  - 2) Please do not clean the products in the case of using a non-wash-type flux

类型 Type	0201 , 0402	0603 , 0805
溶剂 Solvent	异丙醇 Isopropyl Alcohol	
浸泡清洗 Dipping Cleaning	5 分钟（常温）或者 2 分钟（最高 40°C） Less than 5 min.at room temp. or Less than 2 min. at 40 °C max.	
超声波清洗 Ultrasonic Cleaning	5 分钟以下，20W/L 频率 28kHz 到 40kHz Less than 5 min, 20W/L Frequency of several 28kHz to several 40kHz.	1 分钟以下，20W/L 频率 10kHz 到 100kHz Less than 1 min, 20W/L Frequency of several 10kHz to several 100kHz.

• **干燥**

清洗之后，请迅速将本产品烘干。

• **Drying**

After cleaning, promptly dry this product.

10 R-T 表 R-T table

温度 Temp. (°C)	R 最小值 R_Min (Kohm)	R 中心值 R_Cent (Kohm)	R 最大值 R_Max (Kohm)	阻值公差 Res TOL.	温度公差 Temp. TOL.(°C)
-40	316.597	345.275	375.609	8.79%	1.26
-39	296.180	322.791	350.913	8.71%	1.26
-38	277.219	301.925	328.010	8.64%	1.26
-37	259.601	282.549	306.757	8.57%	1.26
-36	243.223	264.549	287.025	8.50%	1.26
-35	227.988	247.816	268.695	8.43%	1.26
-34	213.810	232.254	251.659	8.35%	1.26
-33	200.608	217.774	235.817	8.29%	1.26
-32	188.310	204.292	221.077	8.22%	1.26
-31	176.847	191.735	207.356	8.15%	1.25
-30	166.157	180.032	194.577	8.08%	1.25
-29	156.184	169.120	182.670	8.01%	1.25
-28	146.875	158.941	171.569	7.94%	1.25
-27	138.181	149.441	161.215	7.88%	1.25
-26	130.059	140.571	151.553	7.81%	1.25
-25	122.466	132.284	142.532	7.75%	1.25
-24	115.350	124.522	134.088	7.68%	1.25
-23	108.694	117.266	126.198	7.62%	1.25
-22	102.465	110.480	118.824	7.55%	1.24
-21	96.632	104.130	111.928	7.49%	1.24
-20	91.170	98.185	105.477	7.43%	1.24
-19	86.050	92.618	99.438	7.36%	1.24
-18	81.251	87.402	93.783	7.30%	1.24
-17	76.750	82.513	88.486	7.24%	1.24
-16	72.526	77.927	83.521	7.18%	1.24
-15	68.562	73.626	78.866	7.12%	1.23
-14	64.839	69.588	74.499	7.06%	1.23
-13	61.341	65.797	70.401	7.00%	1.23
-12	58.053	62.237	66.554	6.94%	1.23
-11	54.962	58.890	62.941	6.88%	1.23
-10	52.055	55.744	59.546	6.82%	1.23
-9	49.319	52.786	56.355	6.76%	1.22
-8	46.744	50.002	53.354	6.70%	1.22
-7	44.318	47.382	50.531	6.65%	1.22
-6	42.034	44.916	47.875	6.59%	1.22
-5	39.880	42.592	45.374	6.53%	1.22
-4	37.847	40.400	43.016	6.48%	1.21
-3	35.930	38.333	40.794	6.42%	1.21
-2	34.122	36.385	38.701	6.36%	1.21
-1	32.416	34.548	36.727	6.31%	1.21
0	30.805	32.814	34.866	6.26%	1.21
1	29.285	31.179	33.113	6.20%	1.20

温度 Temp. (°C)	R 最小值 R_Min (Kohm)	R 中心值 R_Cent (Kohm)	R 最大值 R_Max (Kohm)	阻值公差 Res TOL.	温度公差 Temp. TOL.(°C)
2	27.850	29.636	31.457	6.15%	1.20
3	26.493	28.178	29.895	6.09%	1.20
4	25.210	26.800	28.418	6.04%	1.20
5	23.996	25.497	27.023	5.99%	1.19
6	22.846	24.263	25.703	5.93%	1.19
7	21.758	23.096	24.454	5.88%	1.19
8	20.728	21.992	23.274	5.83%	1.19
9	19.753	20.947	22.157	5.78%	1.18
10	18.829	19.958	21.101	5.73%	1.18
11	17.955	19.022	20.101	5.68%	1.18
12	17.126	18.135	19.155	5.63%	1.18
13	16.340	17.294	18.259	5.58%	1.17
14	15.594	16.498	17.409	5.53%	1.17
15	14.887	15.742	16.604	5.48%	1.17
16	14.216	15.025	15.841	5.43%	1.16
17	13.578	14.345	15.116	5.38%	1.16
18	12.973	13.699	14.429	5.33%	1.16
19	12.398	13.086	13.777	5.28%	1.15
20	11.852	12.504	13.159	5.23%	1.15
21	11.333	11.951	12.571	5.19%	1.15
22	10.840	11.426	12.013	5.14%	1.15
23	10.371	10.926	11.483	5.09%	1.14
24	9.925	10.452	10.979	5.05%	1.14
25	9.500	10.000	10.500	5.00%	1.14
26	9.088	9.570	10.053	5.05%	1.15
27	8.696	9.162	9.628	5.09%	1.17
28	8.323	8.773	9.223	5.14%	1.19
29	7.968	8.402	8.838	5.18%	1.21
30	7.630	8.049	8.470	5.23%	1.22
31	7.309	7.713	8.120	5.27%	1.24
32	7.002	7.393	7.786	5.32%	1.26
33	6.711	7.088	7.468	5.36%	1.28
34	6.433	6.797	7.165	5.41%	1.30
35	6.167	6.520	6.875	5.45%	1.32
36	5.915	6.255	6.599	5.49%	1.34
37	5.674	6.003	6.335	5.54%	1.35
38	5.444	5.762	6.084	5.58%	1.37
39	5.225	5.532	5.843	5.62%	1.39
40	5.015	5.313	5.614	5.67%	1.41
41	4.815	5.103	5.394	5.71%	1.43
42	4.625	4.903	5.185	5.75%	1.45
43	4.442	4.711	4.984	5.79%	1.47
44	4.268	4.529	4.793	5.84%	1.49
45	4.102	4.354	4.610	5.88%	1.51
46	3.943	4.187	4.435	5.92%	1.53

温度 Temp. (°C)	R 最小值 R_Min (Kohm)	R 中心值 R_Cent (Kohm)	R 最大值 R_Max (Kohm)	阻值公差 Res TOL.	温度公差 Temp. TOL.(°C)
47	3.791	4.027	4.267	5.96%	1.55
48	3.646	3.874	4.107	6.00%	1.57
49	3.507	3.728	3.953	6.04%	1.59
50	3.374	3.588	3.806	6.08%	1.61
51	3.247	3.454	3.666	6.12%	1.63
52	3.125	3.326	3.531	6.16%	1.65
53	3.009	3.203	3.402	6.20%	1.67
54	2.897	3.086	3.278	6.24%	1.69
55	2.790	2.973	3.160	6.28%	1.71
56	2.688	2.865	3.046	6.32%	1.73
57	2.590	2.761	2.937	6.36%	1.75
58	2.496	2.662	2.832	6.40%	1.77
59	2.406	2.567	2.732	6.44%	1.79
60	2.319	2.476	2.636	6.48%	1.81
61	2.236	2.388	2.544	6.51%	1.84
62	2.157	2.304	2.455	6.55%	1.86
63	2.081	2.224	2.370	6.59%	1.88
64	2.008	2.146	2.289	6.63%	1.90
65	1.938	2.072	2.210	6.67%	1.92
66	1.870	2.001	2.135	6.70%	1.94
67	1.806	1.932	2.062	6.74%	1.96
68	1.743	1.866	1.993	6.78%	1.99
69	1.684	1.803	1.926	6.81%	2.01
70	1.626	1.742	1.861	6.85%	2.03
71	1.571	1.684	1.800	6.89%	2.05
72	1.518	1.628	1.740	6.92%	2.08
73	1.468	1.574	1.683	6.96%	2.10
74	1.419	1.522	1.628	7.00%	2.12
75	1.372	1.472	1.576	7.03%	2.14
76	1.327	1.424	1.525	7.07%	2.17
77	1.283	1.378	1.476	7.10%	2.19
78	1.241	1.333	1.428	7.14%	2.21
79	1.201	1.290	1.383	7.17%	2.23
80	1.162	1.249	1.339	7.21%	2.26
81	1.125	1.209	1.297	7.24%	2.28
82	1.089	1.171	1.256	7.28%	2.30
83	1.054	1.134	1.217	7.31%	2.33
84	1.021	1.099	1.180	7.34%	2.35
85	0.989	1.065	1.143	7.38%	2.37
86	0.958	1.032	1.108	7.41%	2.40
87	0.928	1.000	1.074	7.45%	2.42
88	0.899	0.969	1.042	7.48%	2.45
89	0.872	0.940	1.010	7.51%	2.47
90	0.845	0.911	0.980	7.55%	2.49
91	0.819	0.884	0.951	7.58%	2.52

温度 Temp. (°C)	R 最小值 R_Min (Kohm)	R 中心值 R_Cent (Kohm)	R 最大值 R_Max (Kohm)	阻值公差 Res TOL.	温度公差 Temp. TOL.(°C)
92	0.794	0.857	0.922	7.61%	2.54
93	0.770	0.831	0.895	7.64%	2.57
94	0.747	0.807	0.869	7.68%	2.59
95	0.725	0.783	0.843	7.71%	2.62
96	0.703	0.760	0.819	7.74%	2.64
97	0.683	0.738	0.795	7.77%	2.67
98	0.663	0.716	0.772	7.81%	2.69
99	0.643	0.695	0.750	7.84%	2.72
100	0.625	0.675	0.729	7.87%	2.74
101	0.607	0.656	0.708	7.90%	2.77
102	0.589	0.637	0.688	7.93%	2.79
103	0.572	0.619	0.669	7.96%	2.82
104	0.556	0.602	0.650	7.99%	2.84
105	0.540	0.585	0.632	8.02%	2.87
106	0.525	0.569	0.614	8.05%	2.89
107	0.510	0.553	0.598	8.08%	2.92
108	0.496	0.538	0.581	8.11%	2.95
109	0.482	0.523	0.565	8.15%	2.97
110	0.469	0.508	0.550	8.18%	3.00
111	0.456	0.495	0.535	8.21%	3.02
112	0.443	0.481	0.521	8.23%	3.05
113	0.431	0.468	0.507	8.26%	3.08
114	0.420	0.456	0.493	8.29%	3.10
115	0.408	0.443	0.480	8.32%	3.13
116	0.397	0.432	0.468	8.35%	3.16
117	0.387	0.420	0.455	8.38%	3.18
118	0.376	0.409	0.444	8.41%	3.21
119	0.367	0.399	0.432	8.44%	3.24
120	0.357	0.388	0.421	8.47%	3.26
121	0.348	0.378	0.410	8.50%	3.29
122	0.339	0.368	0.400	8.52%	3.32
123	0.330	0.359	0.390	8.55%	3.35
124	0.321	0.350	0.380	8.58%	3.37
125	0.313	0.341	0.370	8.61%	3.40