

HLMP-D101/D105, HLMP-K101/K105

T-1^{3/4} (5 mm), T-1 (3 mm), High Intensity,
Double Heterojunction AlGaAs Red LED Lamps



Data Sheet

Description

These solid-state LED lamps utilize newly developed double heterojunction (DH) AlGaAs/GaAs material technology. This LED material has outstanding light output efficiency over a wide range of drive currents. The color is deep red at the dominant wavelength of 637 nanometers. These lamps may be DC or pulse driven to achieve desired light output.

Features

- Exceptional brightness
- Wide viewing angle
- Outstanding material efficiency
- Low forward voltage
- CMOS/MOS compatible
- TTL compatible
- Deep red color

Applications

- Bright ambient lighting conditions
- Moving message panels
- Portable equipment
- General use

Package Dimensions

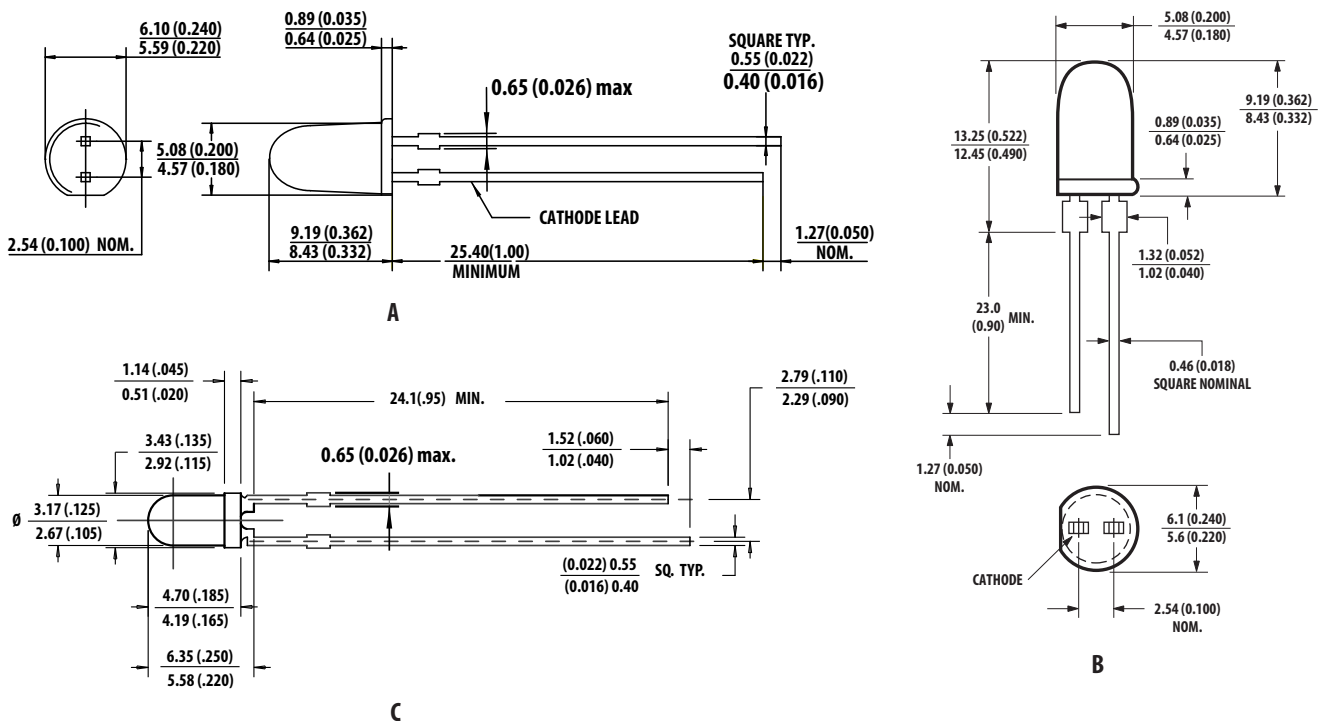

Notes:

1. All dimensions are in mm (inches).
2. An epoxy meniscus may extend about 1 mm (0.040") down the leads.
3. For PCB hole recommendations, see the Precautions section.

Selection Guide

| Package Description | Device HLMP- | Luminous Intensity Iv (mcd) at 20 mA | | | 2 $\theta_{1/2}$ ^[1] Degree | Package Outline |
|-----------------------------------|--------------|--------------------------------------|-------|-------|---|--------------------|
| | | Min. | Typ. | Max. | | |
| T-1 3/4 Red Tinted Diffused | D101 | 35.2 | 70.0 | – | 65 | A |
| | D101-J00xx | 35.2 | 70.0 | – | 65 | A |
| | D101-JK0xx | 35.2 | 70.0 | 112.8 | 65 | A |
| T-1 3/4 Red Untinted Non-diffused | D105 | 138.0 | 240.0 | – | 24 | B |
| | D105-M00xx | 138.0 | 240.0 | – | 24 | B |
| T-1 Red Tinted Diffused | K101 | 22.0 | 45.0 | – | 60 | C |
| | K101-I00xx | 22.0 | 45.0 | – | 60 | C |
| T-1 Red Untinted Non-diffused | K105 | 35.2 | 65.0 | – | 45 | C |
| | K105-J00xx | 35.2 | 65.0 | – | 45 | C |

Note:

1. $\theta_{1/2}$ is the off axis angle from lamp centerline where the luminous intensity is $1/2$ the on-axis value.

Part Numbering System

HLMP - x x xx - x x x xx

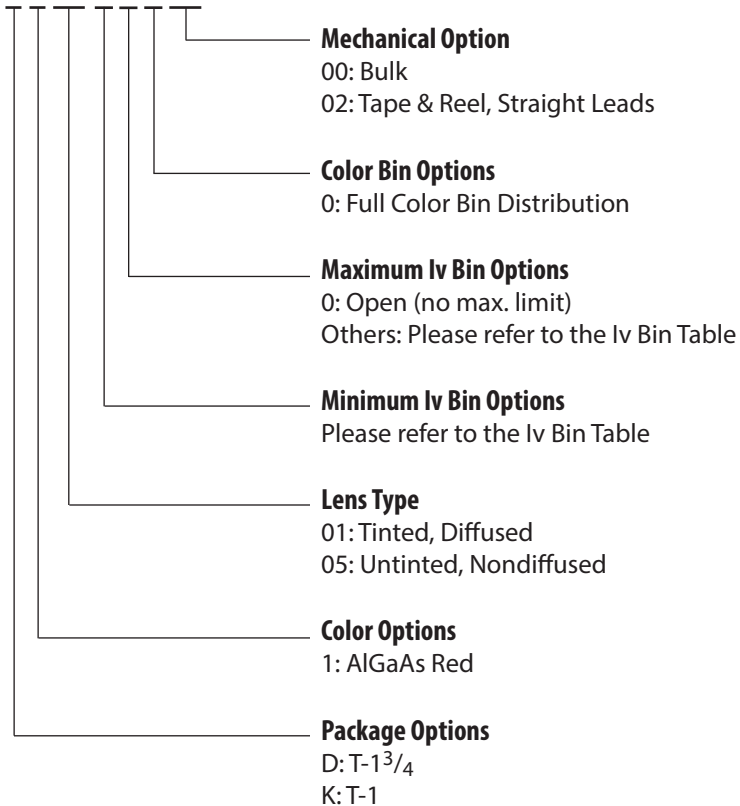

Absolute Maximum Ratings at $T_A = 25^\circ\text{C}$

| Parameter | Value |
|---|---------------|
| Peak Forward Current ^[1,2] | 300 mA |
| Average Forward Current ^[2] | 20 mA |
| DC Current ^[3] | 30 mA |
| Power Dissipation | 87 mW |
| Reverse Voltage ($I_R = 100 \mu\text{A}$) | 5 V |
| Transient Forward Current (10 μs Pulse) ^[4] | 500 mA |
| LED Junction Temperature | 110°C |
| Operating Temperature Range | -20 to +100°C |
| Storage Temperature Range | -40 to +100°C |

Notes:

1. Maximum I_{PEAK} at $f = 1 \text{ kHz}$, $DF = 6.7\%$.
2. Refer to Figure 6 to establish pulsed operating conditions.
3. Derate linearly as shown in Figure 5.
4. The transient peak current is the maximum non-recurring peak current the device can withstand without damaging the LED die and wire bonds. It is not recommended that the device be operated at peak currents beyond the Absolute Maximum Peak Forward Current.

Electrical/Optical Characteristics at $T_A = 25^\circ\text{C}$

| Symbol | Description | Min. | Typ. | Max. | Unit | Test Condition |
|-----------------------|---------------------------|------|--|------|---------------------------|---|
| V_F | Forward Voltage | | 1.8 | 2.2 | V | $I_F = 20 \text{ mA}$ |
| V_R | Reverse Breakdown Voltage | 5.0 | 15.0 | | V | $I_R = 100 \mu\text{A}$ |
| λ_p | Peak Wavelength | | 645 | | nm | Measurement at Peak |
| λ_d | Dominant Wavelength | | 637 | | nm | Note 1 |
| $\Delta\lambda^{1/2}$ | Spectral Line Halfwidth | | 20 | | nm | |
| τ_s | Speed of Response | | 30 | | ns | Exponential Time Constant, e^{-t}/T_s |
| C | Capacitance | | 30 | | pF | $V_F = 0, f = 1 \text{ MHz}$ |
| $R\theta_{J-PIN}$ | Thermal Resistance | | 260 ^[3] 210 ^[4] 290 ^[5] | | $^\circ\text{C}/\text{W}$ | Junction to Cathode Lead |
| η_V | Luminous Efficacy | | 80 | | lm/W | Note 2 |

Notes:

1. The dominant wavelength, λ_d , is derived from the CIE chromaticity diagram and represents the color of the device.
2. The radiant intensity, I_e , in watts per steradian, may be found from the equation $I_e = I_V/\eta_V$, where I_V is the luminous intensity in candelas and η_V is luminous efficacy in lumens/watt.
3. HLMP-D101.
4. HLMP-D105.
5. HLMP-K101/-K105.

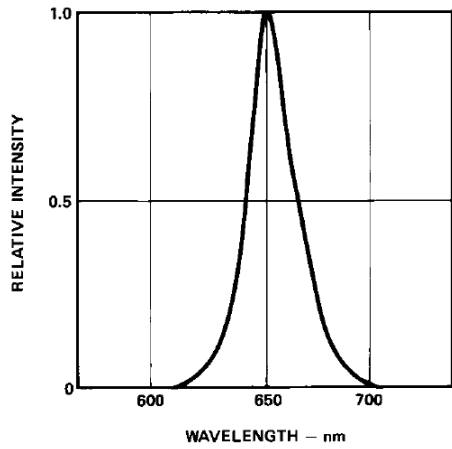

Figure 1. Relative intensity vs. wavelength.

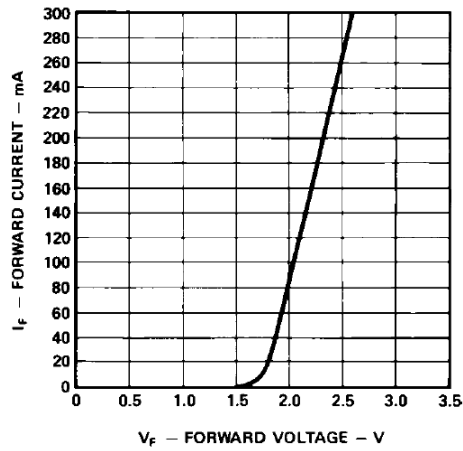

Figure 2. Forward current vs. forward voltage.

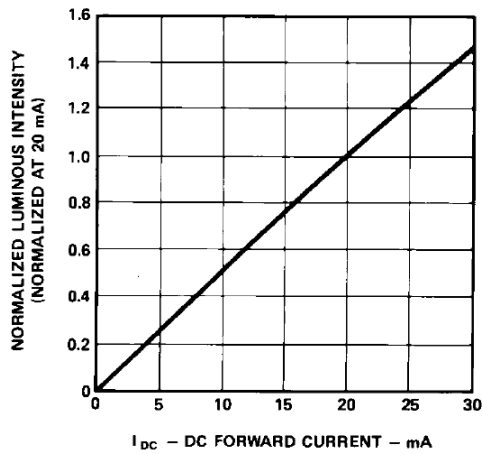

Figure 3. Relative luminous intensity vs. dc forward current.

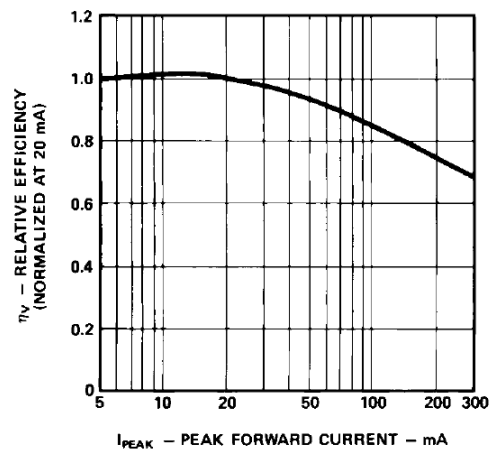

Figure 4. Relative efficiency vs. peak forward current.

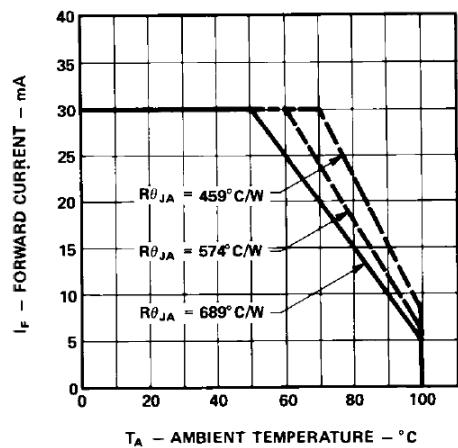

Figure 5. Maximum forward dc current vs. ambient temperature. Derating based on $T_J \text{ MAX.} = 110^\circ\text{C}$.

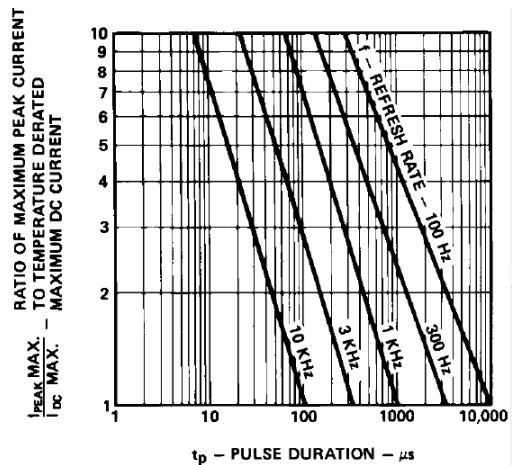

Figure 6. Maximum tolerable peak current vs. peak duration ($I_{\text{PEAK MAX.}}$ determined from temperature derated $I_{\text{DC MAX.}}$).

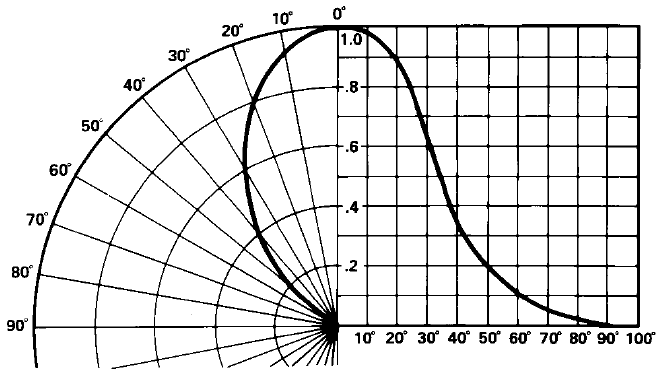

Figure 7. Relative luminous intensity vs. angular displacement. HLMP-D101.

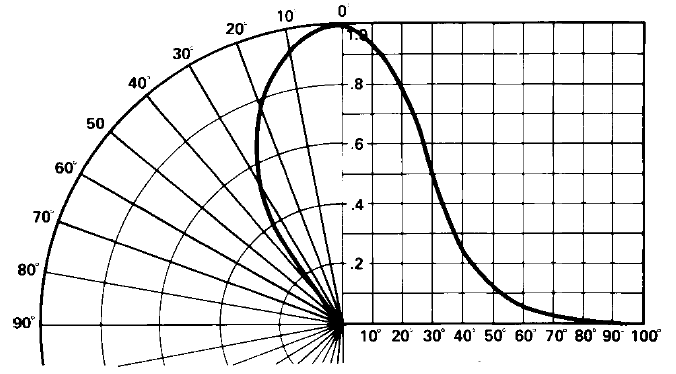

Figure 8. Relative luminous intensity vs. angular displacement. HLMP-K101.

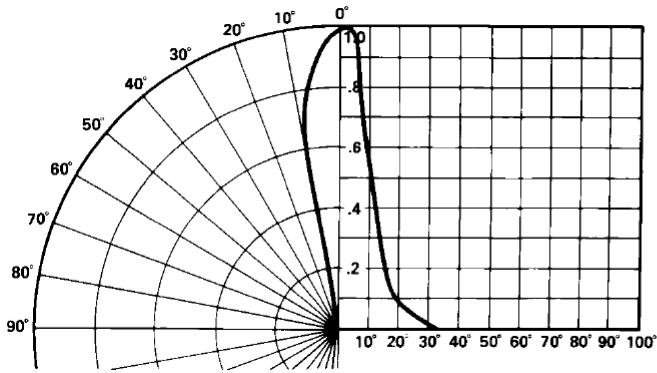

Figure 9. Relative luminous intensity vs. angular displacement. HLMP-D105.

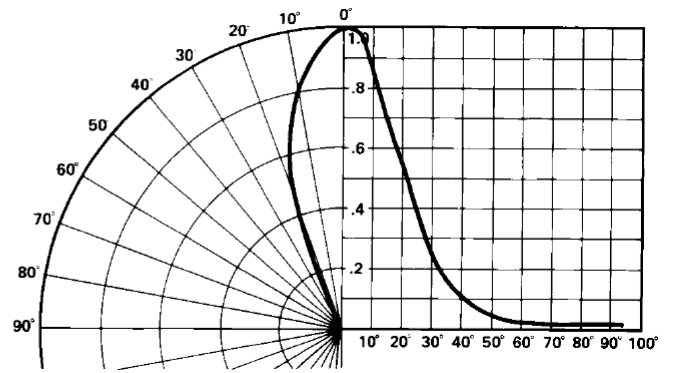

Figure 10. Relative luminous intensity vs. angular displacement. HLMP-K105.

Intensity Bin Limits

| Color | Bin | Intensity Range (mcd) | |
|-------|---------|-----------------------|---------|
| | | Min. | Max. |
| Red | I | 24.8 | 39.6 |
| | J | 39.6 | 63.4 |
| | K | 63.4 | 101.5 |
| | L | 101.5 | 162.4 |
| | M | 162.4 | 234.6 |
| | N | 234.6 | 340.0 |
| | O | 340.0 | 540.0 |
| | P | 540.0 | 850.0 |
| | Q | 850.0 | 1200.0 |
| | R | 1200.0 | 1700.0 |
| | S | 1700.0 | 2400.0 |
| | T | 2400.0 | 3400.0 |
| | U | 3400.0 | 4900.0 |
| | V | 4900.0 | 7100.0 |
| | W | 7100.0 | 10200.0 |
| | X | 10200.0 | 14800.0 |
| | Y | 14800.0 | 21400.0 |
| Z | 21400.0 | 30900.0 | |

Maximum tolerance for each bin limit is $\pm 18\%$.

Mechanical Option Matrix

| Mechanical Option Code | Definition |
|------------------------|--|
| 00 | Bulk Packaging, minimum increment 500 pcs/bag |
| 02 | Tape & Reel, straight leads, minimum increment 1300 pcs (T-1 ^{3/4})/1800 pcs (T-1) |

Note:

All categories are established for classification of products. Products may not be available in all categories. Please contact your local Avago representative for further clarification/information.

Precautions

Lead Forming:

- The leads of an LED lamp may be preformed or cut to length prior to insertion and soldering on PC board.
- For better control, it is recommended to use proper tool to precisely form and cut the leads to applicable length rather than doing it manually.
- If manual lead cutting is necessary, cut the leads after the soldering process. The solder connection forms a mechanical ground which prevents mechanical stress due to lead cutting from traveling into LED package. This is highly recommended for hand solder operation, as the excess lead length also acts as small heat sink.

Soldering and Handling:

- Care must be taken during PCB assembly and soldering process to prevent damage to the LED component.
- LED component may be effectively hand soldered to PCB. However, it is only recommended under unavoidable circumstances such as rework. The closest manual soldering distance of the soldering heat source (soldering iron's tip) to the body is 1.59mm. Soldering the LED using soldering iron tip closer than 1.59mm might damage the LED.

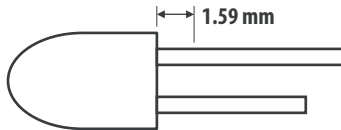

- ESD precaution must be properly applied on the soldering station and personnel to prevent ESD damage to the LED component that is ESD sensitive. Do refer to Avago application note AN 1142 for details. The soldering iron used should have grounded tip to ensure electrostatic charge is properly grounded.
- Recommended soldering condition:

| | Wave Soldering ^{[1],[2]} | Manual Solder Dipping |
|----------------------|-----------------------------------|-----------------------|
| Pre-heat Temperature | 105°C Max. | – |
| Pre-heat Time | 60 sec Max. | – |
| Peak Temperature | 250°C Max. | 260°C Max. |
| Dwell Time | 3 sec Max. | 5 sec Max. |

Note:

1. Above conditions refers to measurement with thermocouple mounted at the bottom of PCB.
2. It is recommended to use only bottom preheaters in order to reduce thermal stress experienced by LED.

- Wave soldering parameters must be set and maintained according to the recommended temperature and dwell time. Customer is advised to perform daily check on the soldering profile to ensure that it is always conforming to recommended soldering conditions.

Note:

1. PCB with different size and design (component density) will have different heat mass (heat capacity). This might cause a change in temperature experienced by the board if same wave soldering setting is used. So, it is recommended to re-calibrate the soldering profile again before loading a new type of PCB.
 2. Customer is advised to take extra precaution during wave soldering to ensure that the maximum wave temperature does not exceed 250°C and the solder contact time does not exceeding 3sec. Over-stressing the LED during soldering process might cause premature failure to the LED due to delamination.
- Any alignment fixture that is being applied during wave soldering should be loosely fitted and should not apply weight or force on LED. Non metal material is recommended as it will absorb less heat during wave soldering process.
 - At elevated temperature, LED is more susceptible to mechanical stress. Therefore, PCB must allowed to cool down to room temperature prior to handling, which includes removal of alignment fixture or pallet.
 - If PCB board contains both through hole (TH) LED and other surface mount components, it is recommended that surface mount components be soldered on the top side of the PCB. If surface mount need to be on the bottom side, these components should be soldered using reflow soldering prior to insertion the TH LED.
 - Recommended PC board plated through holes (PTH) size for LED component leads.

| | LED Component Lead Size | Diagonal | Plated Through-Hole Diameter |
|------------------------------|---------------------------------------|------------------------|--|
| Lead size (typ.) | 0.45 × 0.45 mm (0.018 × 0.018 in.) | 0.636 mm (0.025 in) | 0.98 to 1.08 mm (0.039 to 0.043 in) |
| Dambar shear-off area (max.) | 0.65 mm (0.026 in) | 0.919 mm (0.036 in) | |
| Lead size (typ.) | 0.50 × 0.50 mm (0.020 × 0.020 in.) | 0.707 mm (0.028 in) | 1.05 to 1.15 mm (0.041 to 0.045 in) |
| Dambar shear-off area (max.) | 0.70 mm (0.028 in) | 0.99 mm (0.039 in) | |

Note: Refer to application note AN1027 for more information on soldering LED components.

- Over-sizing the PTH can lead to twisted LED after clinching. On the other hand under sizing the PTH can cause difficulty inserting the TH LED.

Refer to application note AN5334 for more information about soldering and handling of TH LED lamps.

Example of Wave Soldering Temperature Profile for TH LED

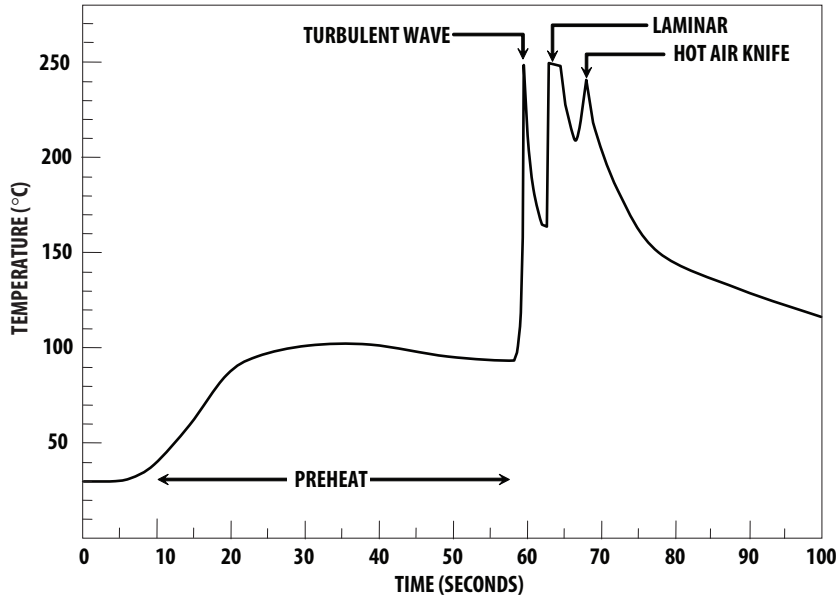

Recommended solder:
Sn63 (Leaded solder alloy)
SAC305 (Lead-free solder alloy)

Flux: Rosin flux

Solder bath temperature:
245 °C ± 5 °C (maximum peak temperature = 250 °C)

Dwell time: 1.5 sec – 3.0 sec (maximum = 3 sec)

Note: Allow for board to be sufficiently cooled to room temperature before you exert mechanical force.

For product information and a complete list of distributors, please go to our web site: www.avagotech.com

Avago, Avago Technologies, and the A logo are trademarks of Avago Technologies in the United States and other countries.
Data subject to change. Copyright © 2005-2015 Avago Technologies. All rights reserved.
AV02-0230EN - October 6, 2015

AVAGO
TECHNOLOGIES