



深圳市凯越翔电子有限公司

贴片晶振规格书

产品名称:	贴片晶振
产品型号:	5032/20.000 MHZ
产品参数:	8 PF/±10ppm
原厂型号:	K5A200000810
凯越翔技术部:	董宗全

客 户 确 认 栏

认 证 印 章	负 责 人 印 章
年 月 日	年 月 日

本规格章程连同本页共 5 页

1. General item

Nominal frequency: **20.000 MHz**

Vibration mode: AT Fund.

Operation temperature range: **-40°C~+85°C**

Storage temperature rang: **-40°C~+85°C**

Test machine: **S&A 250B**

Drive level: **100 μW**

Load capacitance: **8 pF**

2. Electrical characteristics

Condition: **25 ± 3°C** Relatively humidity $\leq 60\%$

2.1 Frequency tolerance: **± 10ppm**

2.2 Equivalent resistance: $\leq 60 \Omega$

2.3 Temperature characteristics: **± 20ppm**

2.4 Shunt capacitance: $\leq 7\text{pF}$

2.5 Insulation resistance: $\geq 500\text{M} \Omega / 100 \pm 15\text{V}_{\text{DC}}$

2.6 Aging characteristics: **± 5ppm/year**

3. Reliability specification

3.1 Drop characteristics

Condition: height 50cm, 3 times, test after 1 hour

Equipment: S&A250B, thickness 3cm hard wood

Standard: frequency change: $\leq \pm 5\text{ppm}$, Rr as specification

3.2 Shake characteristics

Condition: shake frequency 10~55Hz, cyc1~2 minutes, swing 1.5mm,
direction x/y/z, all 30 minutes. Test after 1 hour

Equipment: S&A250B, test machine

Standard: frequency change: $\leq \pm 5\text{ppm}$, Rr as specification

3.3 Airproof characteristics

Condition: put crystal into the pressure cabin with alcohol, keep pressure 0.4-0.5mpa 10 minutes, then take out and blow for 5 minutes

Equipment: IR machine

Standard: IR $\geq 500 \text{ m}\Omega$

3.4 Weld characteristics

Condition: $235 \pm 5^\circ\text{C}$ 、3 seconds

Equipment: test machine

Standard: 90% adhibit tin ok

3.5 Humidity characteristics

Condition: $40^\circ\text{C} \pm 2^\circ\text{C}$, humidity 90-95%,250 hours.

Equipment: S&A250B, test cabin

Standard: frequency change: $\leq \pm 5\text{ppm}$, Rr as specification

3.6 Low temperature characteristics

Condition: $-30^\circ\text{C} \pm 2^\circ\text{C}$, after 250 hours, put in room temperature 1 hour

Equipment: S&A250B, test machine

Standard: frequency change: $\leq \pm 5\text{ppm}$, Rr as specification

3.7 High temperature characteristics

Condition: $85^\circ\text{C} \pm 2^\circ\text{C}$, after 250 hours, put in room temperature 1 hour

Equipment: S&A250B, test machine

Standard: frequency change: $\leq \pm 5\text{ppm}$, Rr as specification

3.8 Temperature cycling

Condition:



AFTER TEMPERATURE CYCLING

Equipment: S&A250B, test machine。

Standard: frequency change: $\leq \pm 5\text{ppm}$, Rr as specification

3.9 Refluence examination

Condition:

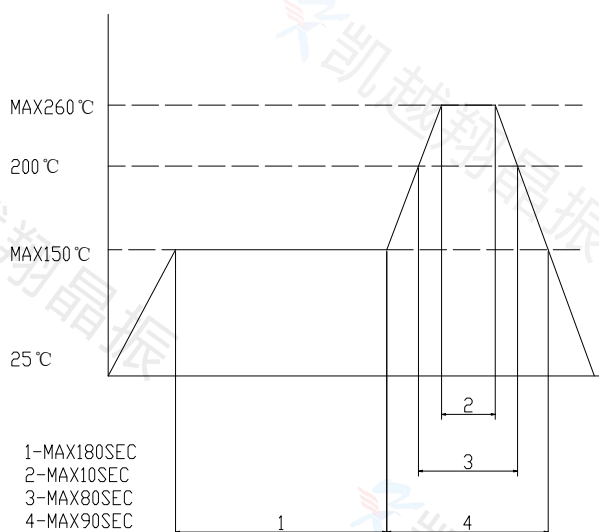

Equipment: S&A250B, test machine

Standard: frequency change: $\leq \pm 10\text{ppm}$,

Rr as specification

External dimensions

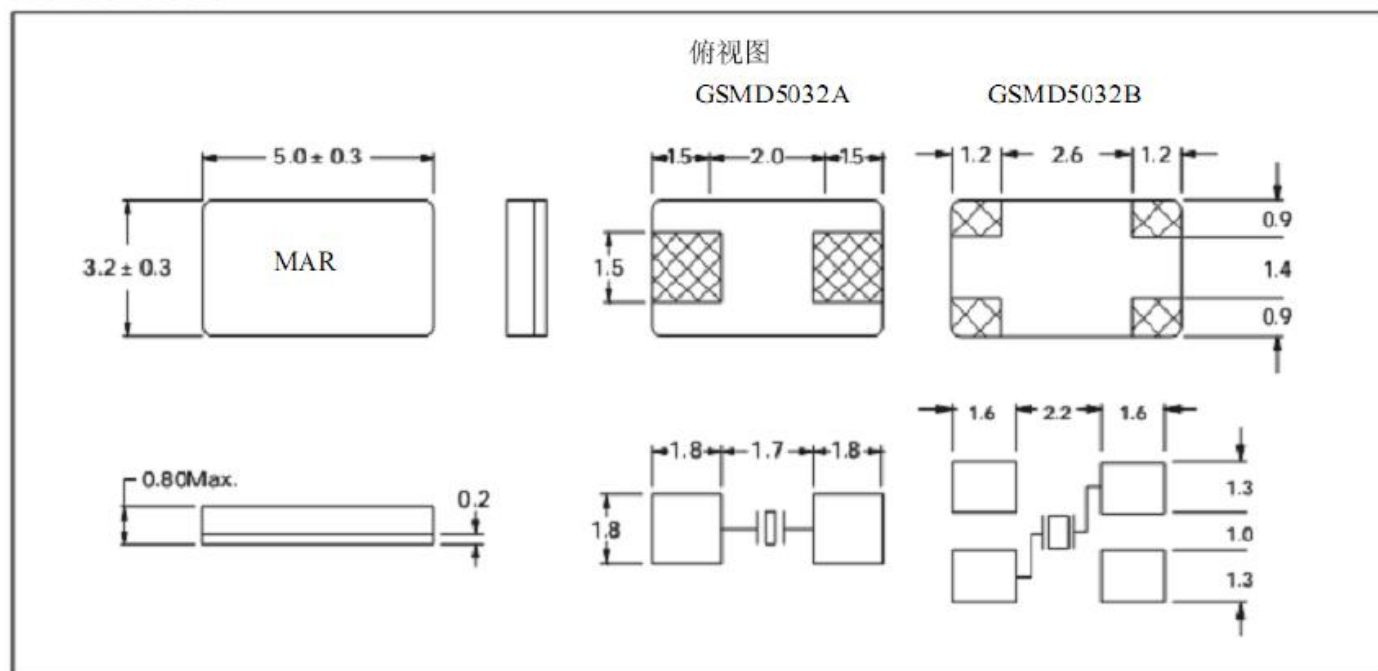

Dimension: mm