

REV.	ECN NO.	LOCATION	DESCRIPTION	DATE	DESIGN
X1			INITIAL RELEASE	22,11,29	JACKY
X2			ADD 6/8/12/14/16/18/20POS	23,04,18	JACKY
X3		△	Modify the material number rules and cancel the hole and add the packaging diagram.	23,07,13	JACKY

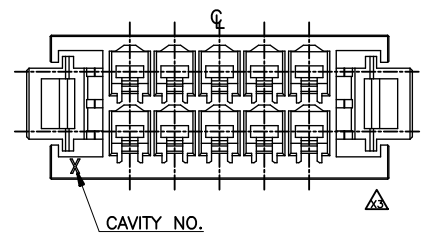

NOTES:
 PRODUCT MUST MEET CONTROLLED SUBSTANCES SPEC. ROHS 2.0
 1. MATERIAL: HIGH TEMPERATURE THERMOPLASTIC
 2. THE SHAPE, SIZE AND POSITION OF THE CHARACTER SHOW THE OUTLINE. THEY DON'T SHOW DETAILS.
 3. UNSPECIFIED TOLERANCE: X:±0.30 X:±5°
 .X±0.25 .X±3°
 .XX±0.20

△ 4. PART NUMBER INFORMATION:
 56**BG-***R * * * 00000

- RESERVE NUMBER
- PACKAGE CODE:
B: BAG PACING
- LOGO:
1: WITH DEREN LOGO
2: WITHOUT LOGO
- HOUSING COLOR:
1: BLACK
2: WHITE
- WATER CODE: 001~ZZZ
- POS CODE:
06: 6POS
08: 8POS
0A: 10POS
0C: 12POS
0E: 14POS
0G: 16POS
0J: 18POS
0L: 20POS

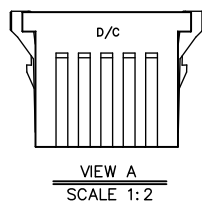
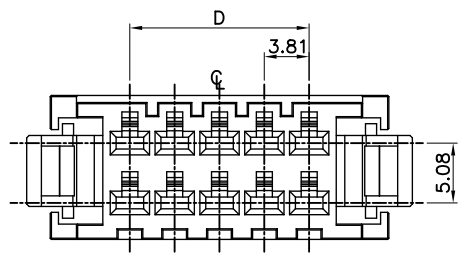
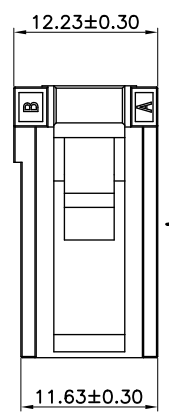
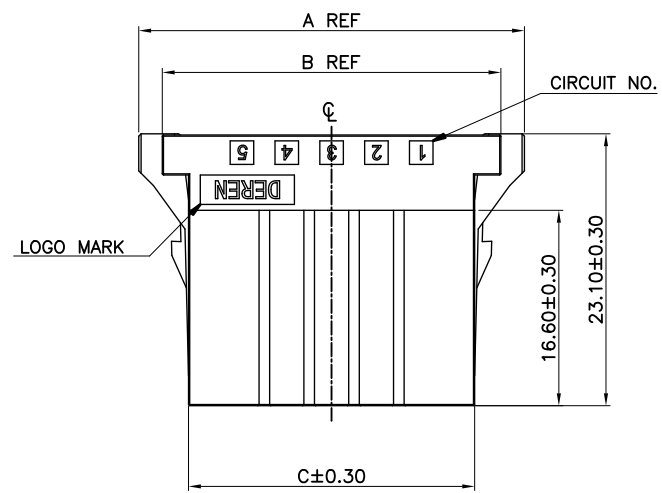

20	560LBG-014R***00000	50.62	47.83	43.37	34.29
18	560JBG-006R***00000	46.81	44.02	39.56	30.48
16	560GBG-012R***00000	43.00	40.21	35.75	26.67
14	560EBG-006R***00000	39.19	36.40	31.94	22.86
12	560CBG-012R***00000	35.38	32.59	28.13	19.05
10	560ABG-016R***00000	31.57	28.78	24.32	15.24
08	5608BG-009R***00000	27.76	24.97	20.51	11.43
06	5606BG-015R***00000	23.95	21.16	16.70	7.62
POS	PART NUMBER	A	B	C	D

DIM	TOL	DIM	TOL	 DEREN SHENZHEN DEREN ELECTRONIC CO., LTD
X.	±0.30	X.	±2°	
.X	±0.25	.X	±1°	C-DWG: [] DATE: [] TITLE: DR380 D_Wire Rec_6~20Pin Pitch3.81 HSG
.XX	±0.20			
		DRAW NO. SC2309321-1		DESIGN: JACKY
		REV. X3		CHECK: []
				DATE: 23,07,13
				APPROVAL: []
				P/N: 56**BG-***R***00000
				SHEET: 1/3
				SCALE: N/A UNIT: mm

1 2 3 4 5 6 7 8

REV.	ECN NO.	LOCATION	DESCRIPTION	DATE	DESIGN
X1			INITIAL RELEASE	22,11,29	JACKY
X2			ADD 6/8/12/14/16/18/20POS	23,04,18	JACKY
X3		▲	Modify the material number rules and cancel the hole and add the packaging diagram.	23,07,13	JACKY

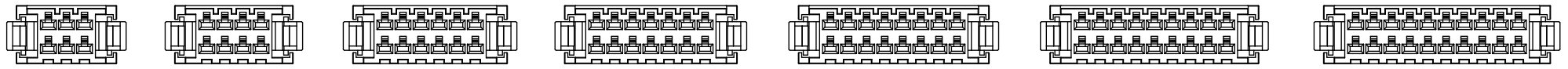
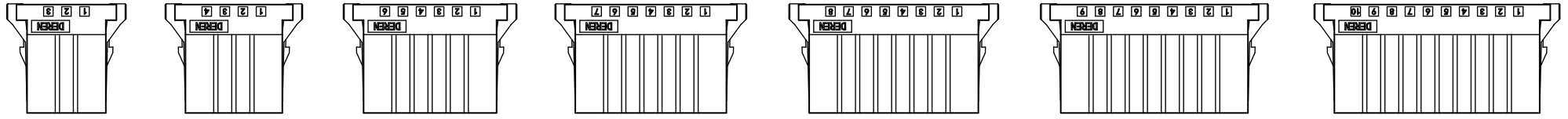
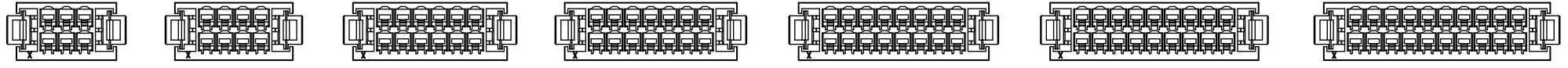

6POS

8POS

12POS

14POS

16POS

18POS

20POS

DIM	TOL	DIM	TOL	 DEREN SHENZHEN DEREN ELECTRONIC CO., LTD
X.	±0.30	X.	±2°	
.X	±0.25	.X	±1°	
.XX	±0.20			
		DRAW NO. SC2309321-1		C-DWG:
		REV. X3		DESIGN: JACKY
				DATE: 23,07,13
				TITLE: DR380 D_Wire Rec_6~20Pin Pitch3.81 HSG
				P/N: 56**BG-***R***00000
				SHEET: 2/3
				SCALE: N/A
				UNIT: mm

1 2 3 4 5 6 7 8

REV.	ECN NO.	LOCATION	DESCRIPTION	DATE	DESIGN
X1			INITIAL RELEASE	22,11,29	JACKY
X2			ADD 6/8/12/14/16/18/20POS	23,04,18	JACKY
X3		⚠	Modify the material number rules and cancel the hole and add the packaging diagram.	23,07,13	JACKY

A

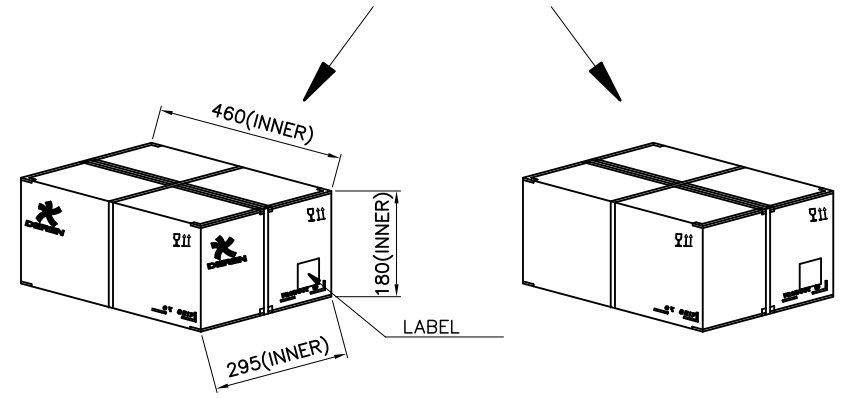
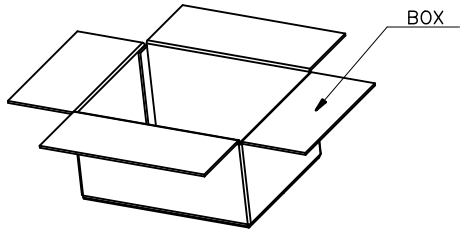
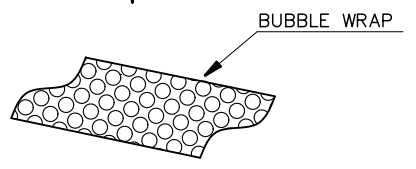
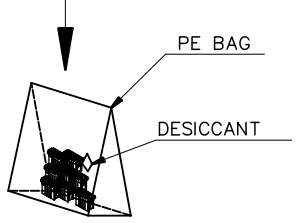
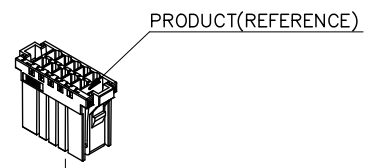

WITH DEREN LOGO
(Used for logo products)

WITHOUT LOGO
(Used for logo-free products)

PACKAGE QUANTITY:

PART NO.	POS	PCS/BAG	BAG/BOX	PCS/BOX
5606BG-015R**B00000	6	240	6	1440
5608BG-009R**B00000	8	190	6	1140
560ABG-016R**B00000	10	150	6	900
560CBG-012R**B00000	12	140	6	840
560EBG-006R**B00000	14	120	6	720
560GBG-012R**B00000	16	100	6	600
560JBG-006R**B00000	18	95	6	570
560LBG-014R**B00000	20	90	6	540

B

C

D

E

DIM	TOL	DIM	TOL	 DEREN SHENZHEN DEREN ELECTRONIC CO., LTD
X.	±0.30	X.	±2°	
.X	±0.25	.X	±1°	
.XX	±0.20			
DRAW NO. SC2309321-1				C-DWG: DATE: 23,07,13
REV. X3				DESIGN: JACKY CHECK: TITLE: DR380 D_Wire Rec_6~20Pin Pitch3.81 HSG P/N: 56**BG-***00000
APPROVAL:				SHEET: 3/3 UNIT: mm
SCALE: N/A				SHEET: 3/3 UNIT: mm

Before the change

3. PART NUMBER INFORMATION:
56**BG-***H * * * 00000

20	560LBG-011H***00000	50.62	47.83	43.37	34.29
18	560JBG-003H***00000	46.81	44.02	39.56	30.48
16	560GBG-009H***00000	43.00	40.21	35.75	26.67
14	560EBG-003H***00000	39.19	36.40	31.94	22.86
12	560CBG-009H***00000	35.38	32.59	28.13	19.05
10	560ABG-013H***00000	31.57	28.78	24.32	15.24
08	5608BG-006H***00000	27.76	24.97	20.51	11.43
06	5606BG-009H***00000	23.95	21.16	16.70	7.62
POS	PART NUMBER	A	B	C	D

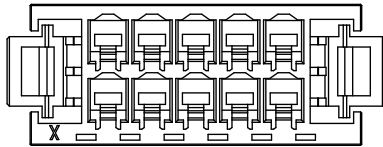

After the change :

3. PART NUMBER INFORMATION:
56**BG-***R * * * 00000

20	560LBG-014R***00000	50.62	47.83	43.37	34.29
18	560JBG-006R***00000	46.81	44.02	39.56	30.48
16	560GBG-012R***00000	43.00	40.21	35.75	26.67
14	560EBG-006R***00000	39.19	36.40	31.94	22.86
12	560CBG-012R***00000	35.38	32.59	28.13	19.05
10	560ABG-016R***00000	31.57	28.78	24.32	15.24
08	5608BG-009R***00000	27.76	24.97	20.51	11.43
06	5606BG-015R***00000	23.95	21.16	16.70	7.62
POS	PART NUMBER	A	B	C	D

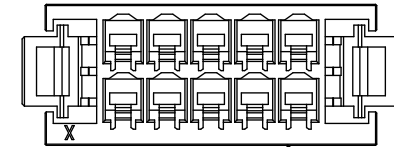

Refer to the 10pin diagram,
other similar effects