

Compensated High Current Choke, 3-phase and neutral line

new



See below:

Approvals and Compliances

Description

- Current compensated choke
- 3-phase and neutral line
- THT-terminals
- Flange for mounting onto printed circuit board

Unique Selling Proposition

- Compact size and light weight
- Open design for optimal cooling
- Nanocrystalline ring cores
- Customer specific pin outs available

Applications

- Frequency converter
- Charge stations
- UPS-systems

Weblinks

[pdf data sheet](#), [html datasheet](#), [General Product Information](#), [Distributor-Stock-Check](#), [Detailed request for product](#), [Landing Page](#)

Technical Data

Rated voltage	500/760 VAC/VDC	Test Voltage	500V: 2150VDC, 2 sec, winding to winding
Rated Current	10 - 40A @ Ta 40 °C		760V: 3300VDC, 2 sec, winding to winding
Rated inductance	0.75 - 6.5mH, Tol. -30% +50%	Climatic Category	40/100/21 acc. to IEC 60068-1
Power Operating Frequency	0 - 400Hz	Allowable Operation Temp.	-40°C to 100°C
Terminal Type	THT		
Weight	100 - 165g		
Material: Housing	UL 94V-0		

Approvals and Compliances

Detailed information on product approvals, code requirements, usage instructions and detailed test conditions can be looked up in [Details about Approvals](#)

SCHURTER products are designed for use in industrial environments. They have approvals from independent testing bodies according to national and international standards. Products with specific characteristics and requirements such as required in the automotive sector according to IATF 16949, medical technology according to ISO 13485 or in the aerospace industry can be offered exclusively with customer-specific, individual agreements by SCHURTER.

Application standards

Application standards where the product can be used

Organization	Design	Standard	Description
	Designed for applications acc.	IEC/UL 60950	IEC 60950-1 includes the basic requirements for the safety of information technology equipment.

Compliances

The product complies with following Guide Lines

Identification	Details	Initiator	Description
	RoHS	SCHURTER AG	Directive RoHS 2011/65/EU, Amendment (EU) 2015/836
	China RoHS	SCHURTER AG	The law SJ / T 11363-2006 (China RoHS) has been in force since 1 March 2007. It is similar to the EU directive RoHS.
	REACH	SCHURTER AG	On 1 June 2007, Regulation (EC) No 1907/2006 on the Registration, Evaluation, Authorization and Restriction of Chemicals 1 (abbreviated as "REACH") entered into force.

Dimension [mm]

52-10

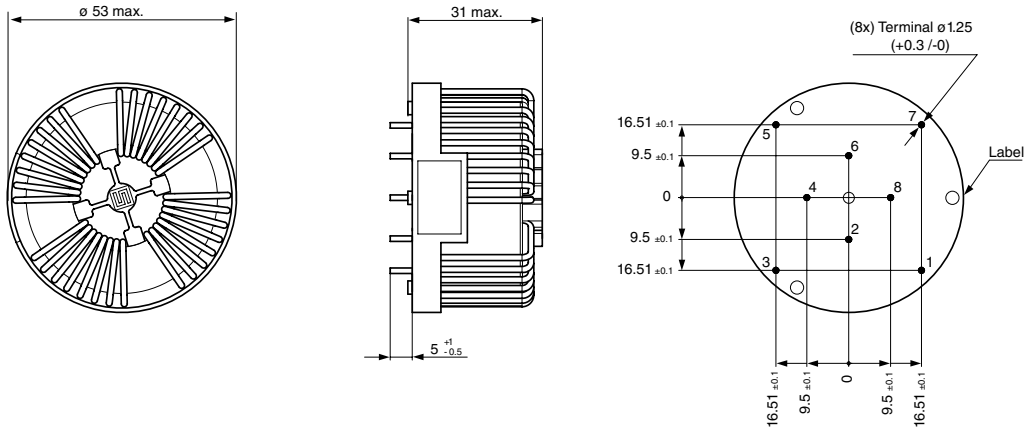

52-12

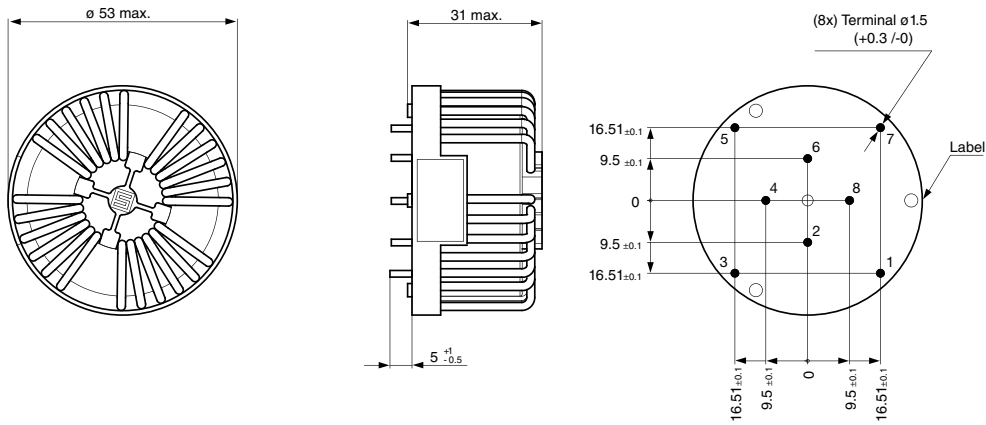

52-16

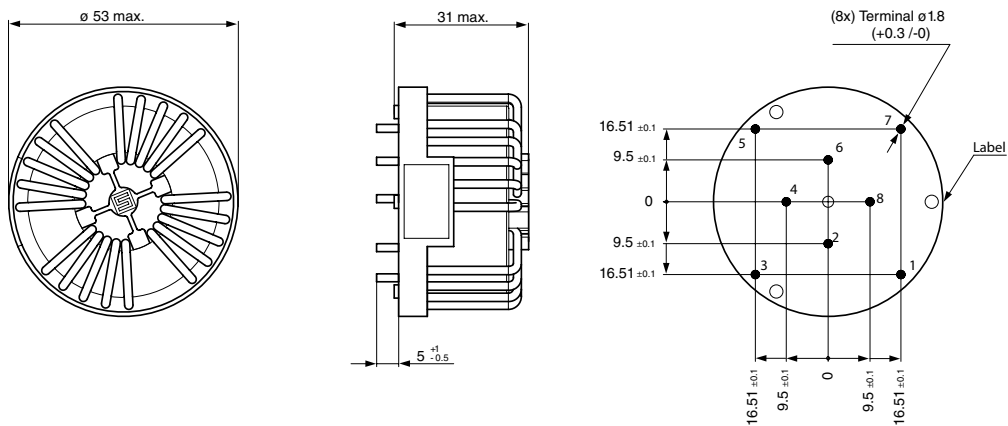

52-25

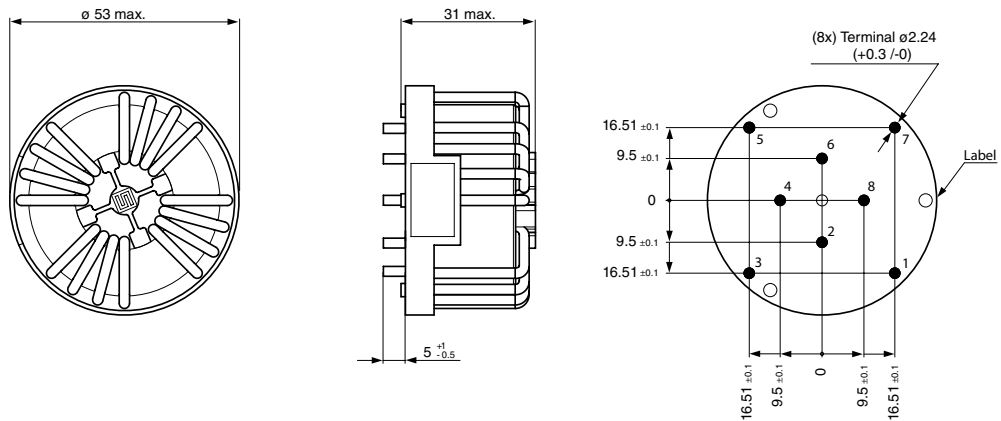

52-32

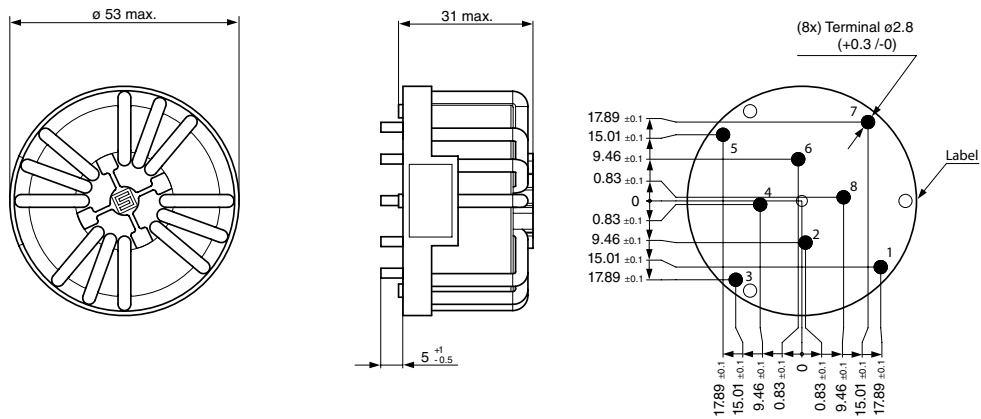

52-40

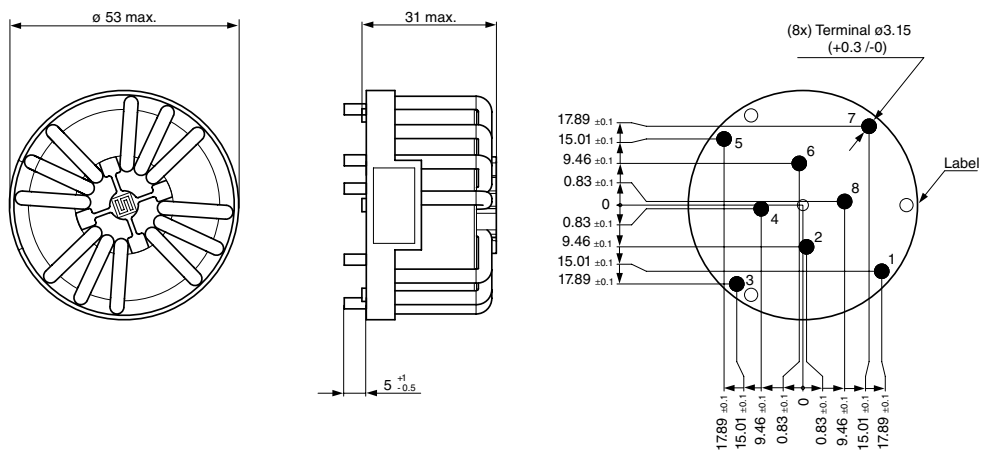

58-10

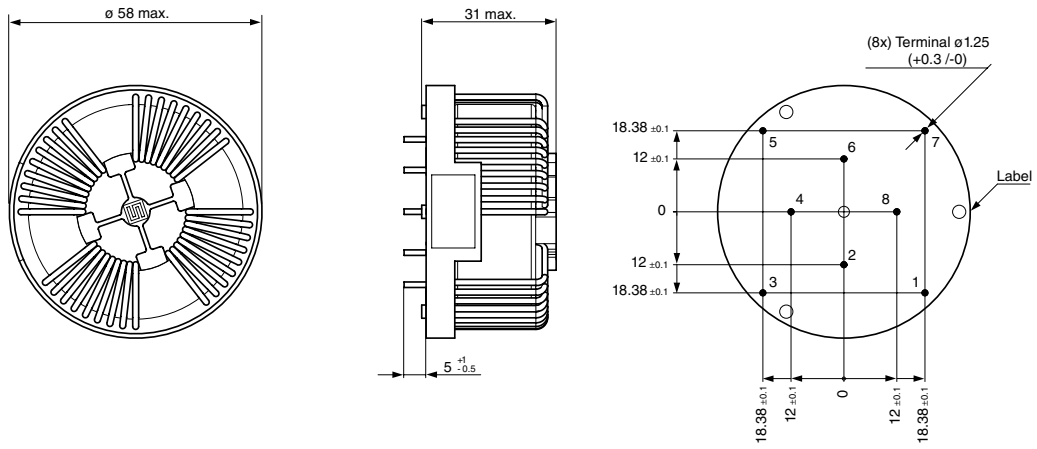

58-12

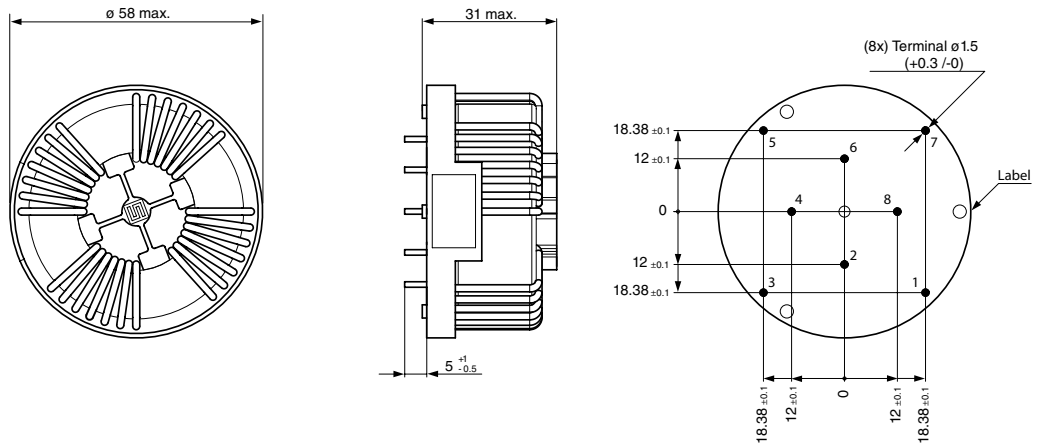

58-16

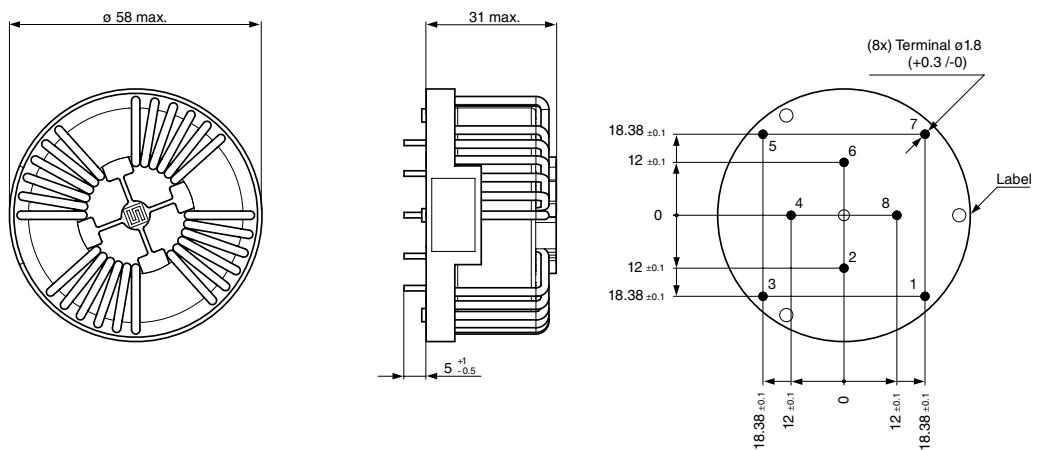

58-32

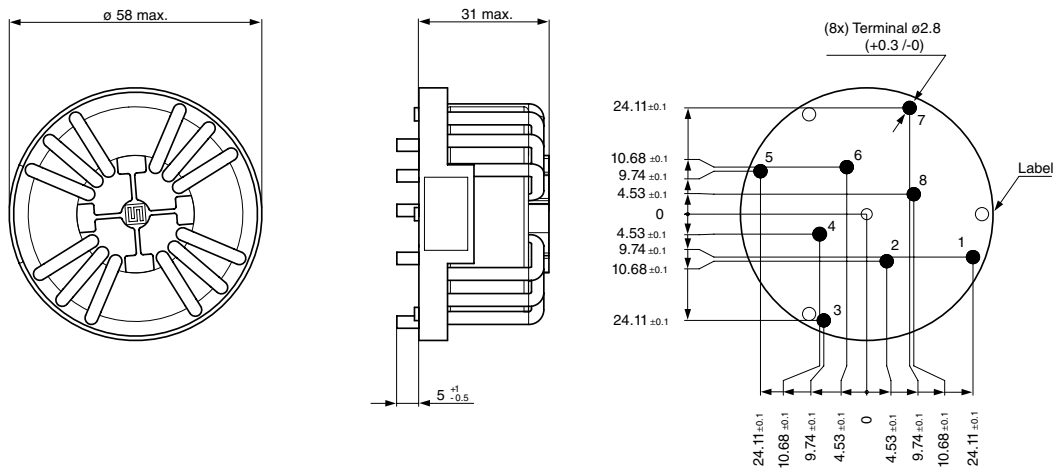

58-40

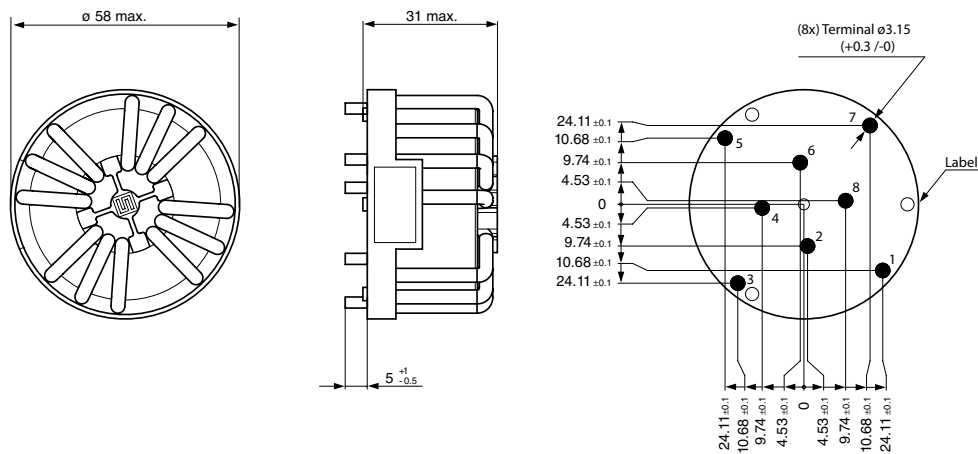

Diagrams

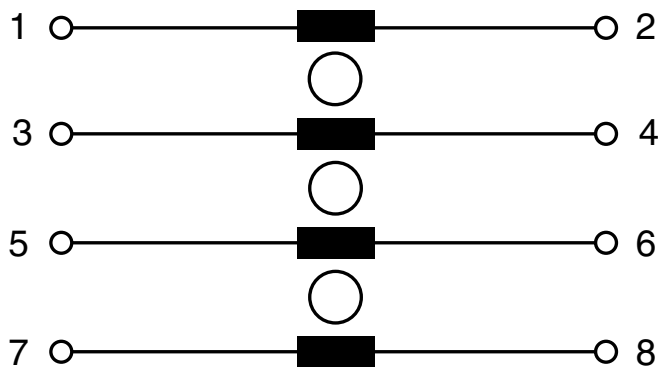

Impedance curves

DKIH-3452-xxxx-NK

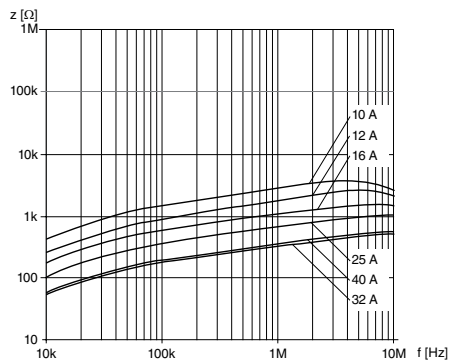

DKIH-3458-xxxx-NK

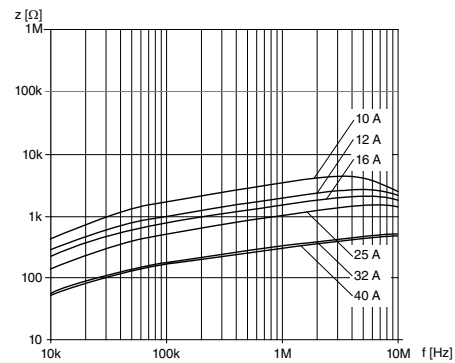

All Variants

I_n [A]	U_n [V]	L_n [mH]	R_{Cu} [mΩ]	Tripped Power Dissipation [W]	f_{RES} [MHz]	Copper ϕ [mm]	Weight [g]	Housings	Packing unit [pcs.]	Order Number
10	500	5.5	7	2.8	3.68	1.25	100 g	52-10	20	3-108-426
12	500	3	3.7	2.13	5.06	1.5	105 g	52-12	20	3-108-427
16	500	2.1	2.12	2.17	6.6	1.8	100 g	52-16	20	3-108-428
25	500	1.35	1.12	2.8	9.56	2.24	110 g	52-25	20	3-108-430
32	500	0.75	0.55	2.25	15.4	2.8	130 g	52-32	20	3-108-431
40	500	0.75	0.44	2.82	13.4	3.15	140 g	52-40	20	3-108-432
10	760	6.5	8	3.2	3.2	1.25	130 g	58-10	20	3-108-433
12	760	4.0	4.33	2.49	4.8	1.5	130 g	58-12	20	3-108-434
16	760	3.0	2.6	2.66	5.18	1.8	140 g	58-16	20	3-108-435
25	760	2.0	1.4	3.5	6.6	2.24	150 g	58-25	20	3-108-437
32	760	0.75	0.55	2.25	15.4	2.8	155 g	58-32	20	3-108-438
40	760	0.75	0.44	2.82	15.4	3.15	165 g	58-40	20	3-108-439

Most Popular.

Availability for all products can be searched real-time: <https://www.schurter.com/en/Stock-Check/Stock-Check-SCHURTER>