

ANGELINA-S

~20° spot beam

SPECIFICATION:

Dimensions	Ø 82.0 mm
Height	31 mm
Fastening	socket
ROHS compliant	yes ⓘ

MATERIALS:

Component	Type	Material	Colour	Finish	Coating
ANGELINA-S	Reflector	PC	metal		HMDS

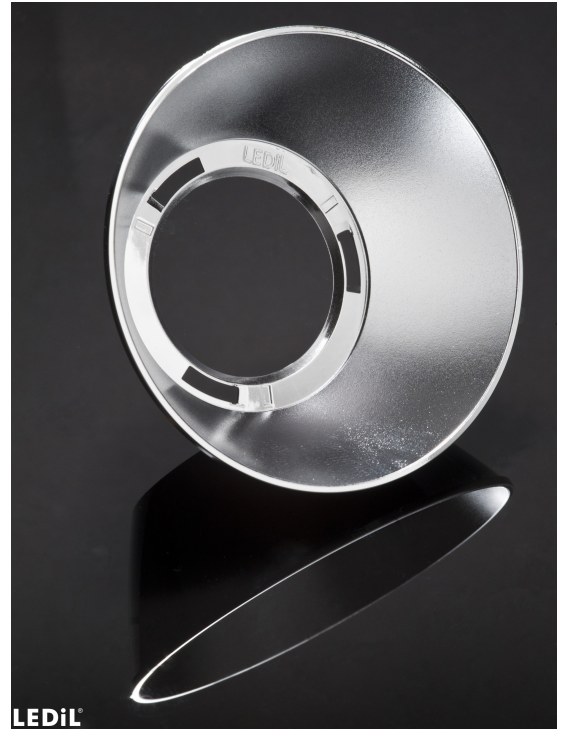

ORDERING INFORMATION:

Component	Qty in box	MOQ	MPQ	Box weight (kg)
F13325_ANGELINA-S » Box size: 480 x 280 x 300 mm	900	120	60	12.7

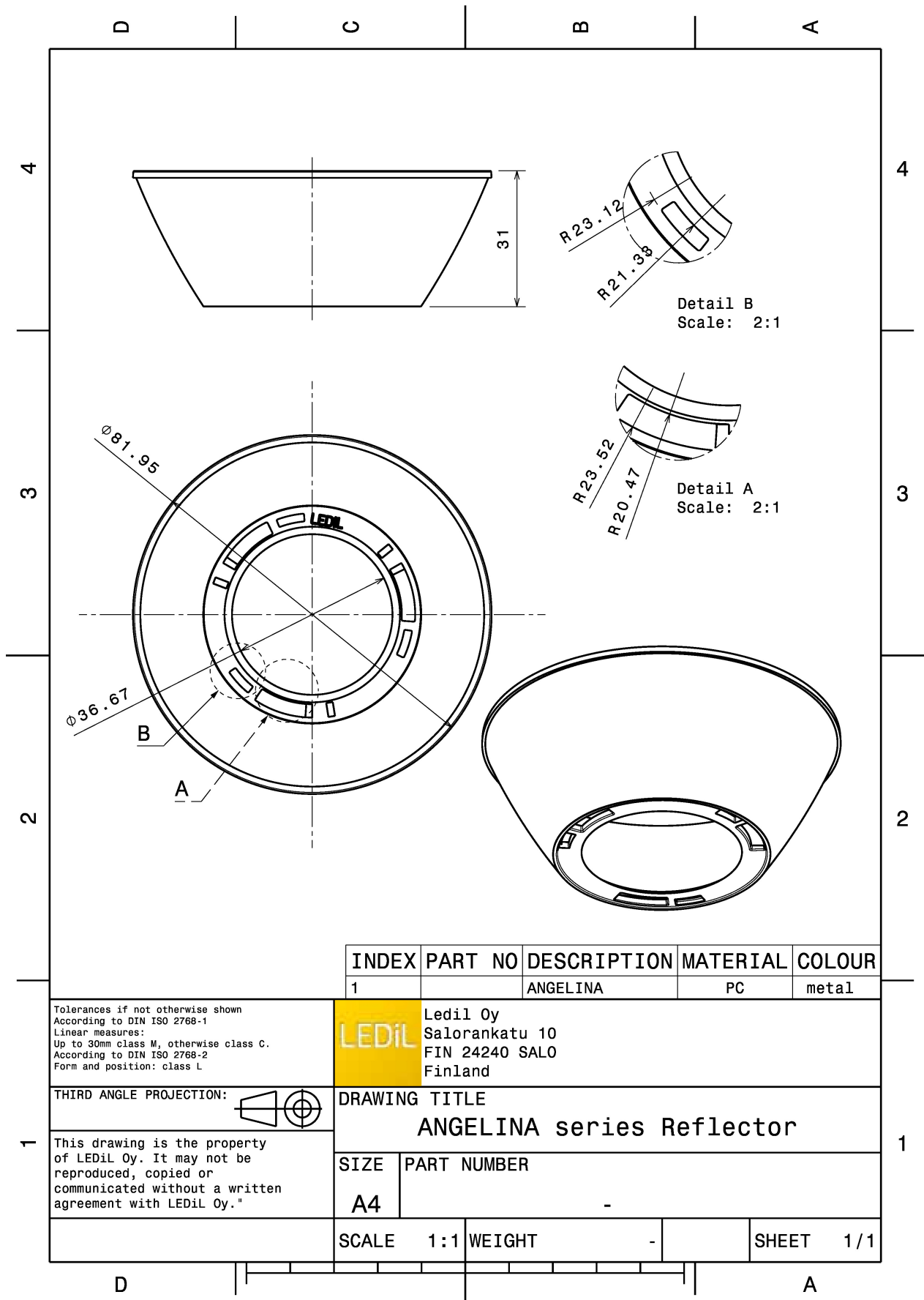

INDEX	PART NO	DESCRIPTION	MATERIAL	COLOUR
1		ANGELINA	PC	metal

Tolerances if not otherwise shown
 According to DIN ISO 2768-1
 Linear measures:
 Up to 30mm class M, otherwise class C.
 According to DIN ISO 2768-2
 Form and position: class L

LEDiL Ledil Oy
 Salorankatu 10
 FIN 24240 SALO
 Finland

THIRD ANGLE PROJECTION:

DRAWING TITLE
ANGELINA series Reflector

This drawing is the property of LEDiL Oy. It may not be reproduced, copied or communicated without a written agreement with LEDiL Oy."

SIZE	PART NUMBER
A4	-

SCALE	1:1	WEIGHT	-	SHEET	1/1
-------	-----	--------	---	-------	-----

See also our general installation guide: www.ledil.com/installation_guide

OPTICAL RESULTS (MEASURED):



LED BXRA ES Rectangle
FWHM / FWTM 17.0° / 75.0°
Efficiency 94 %
Peak intensity 3 cd/lm
LEDs/each optic 1
Light colour/type White
Required components:
 IDEAL: 50-2100BL + 50-2100AN

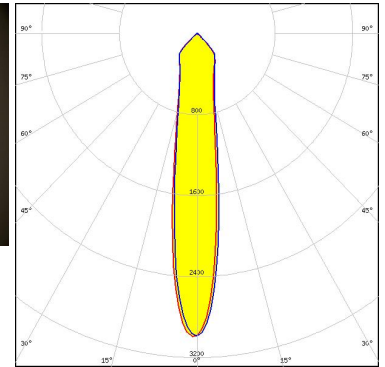
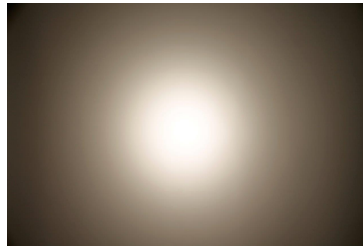

Light distribution files



LED V10 Gen7
FWHM / FWTM 22.0° / 92.0°
Efficiency 88 %
Peak intensity 2 cd/lm
LEDs/each optic 1
Light colour/type White
Required components:
 C13658_CLAMP-VERO13-18
 F13671_ANGE-RZ-LENS
 Bender Wirth: 434 Typ L1

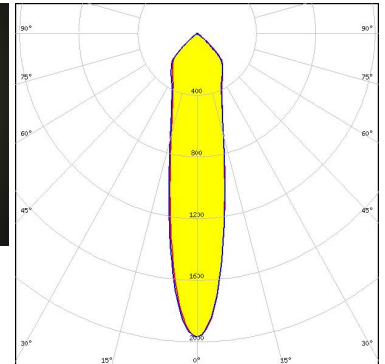
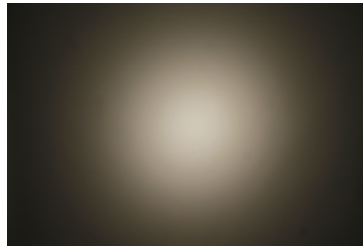

Light distribution files



LED V13 Gen7
FWHM / FWTM 20.0° / 87.0°
Efficiency 94 %
Peak intensity 2.6 cd/lm
LEDs/each optic 1
Light colour/type White
Required components:
 TE Connectivity: 2213254-2 + OPTIC CLIP Z50 TYPE1 2213194-1

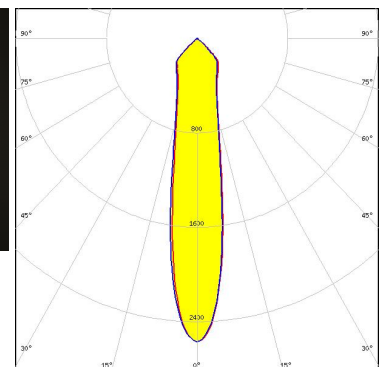
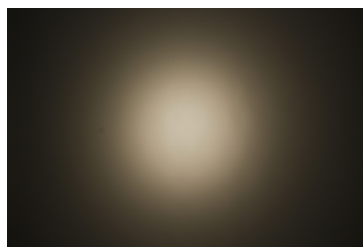

Light distribution files

OPTICAL RESULTS (MEASURED):



LED V15 Gen6
FWHM / FWTM 23.0° / 94.0°
Efficiency 88 %
Peak intensity 2.4 cd/lm
LEDs/each optic 1
Light colour/type White
Required components:
 C13658_CLAMP-VERO13-18
 Bender Wirth: 456 Typ L2

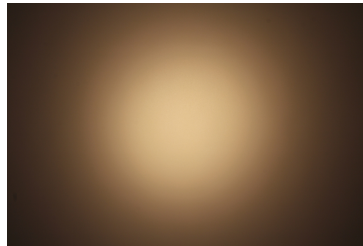

Light distribution files



LED V22 Gen6
FWHM / FWTM 32.0° / 93.0°
Efficiency 88 %
Peak intensity 1.4 cd/lm
LEDs/each optic 1
Light colour/type White
Required components:
 F13671_ANGE-RZ-LENS
 IDEAL: 50-2204-CT + 50-2100AN

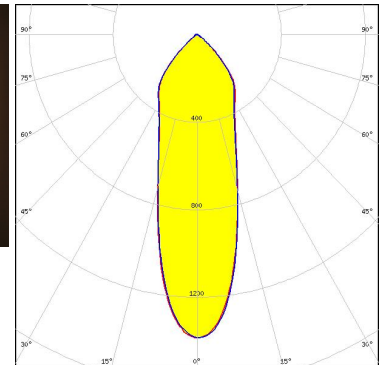
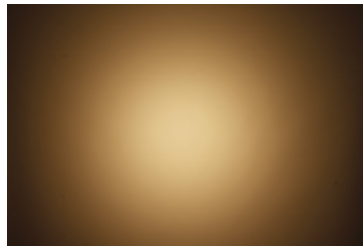

Light distribution files



LED V22 Gen6
FWHM / FWTM 29.0° / 91.0°
Efficiency 92 %
Peak intensity 1.6 cd/lm
LEDs/each optic 1
Light colour/type White
Required components:
 IDEAL: 50-2204-CT + 50-2100AN

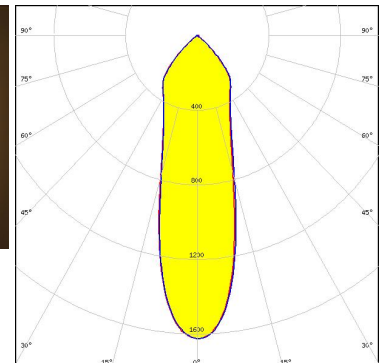
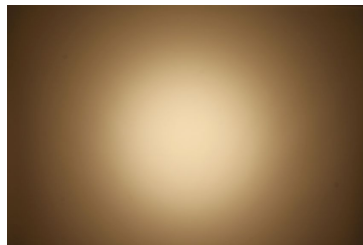

Light distribution files

OPTICAL RESULTS (MEASURED):



LED Vero SE 13
FWHM / FWTM 20.0° / 89.0°
Efficiency 94 %
Peak intensity 2.5 cd/lm
LEDs/each optic 1
Light colour/type White
Required components:
 C16402_CLAMP-VEROSE-13-18

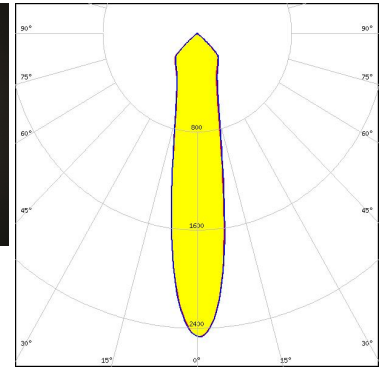

Light distribution files



LED Vero SE 18
FWHM / FWTM 26.0° / 91.0°
Efficiency 94 %
Peak intensity 2 cd/lm
LEDs/each optic 1
Light colour/type White
Required components:
 C16402_CLAMP-VEROSE-13-18

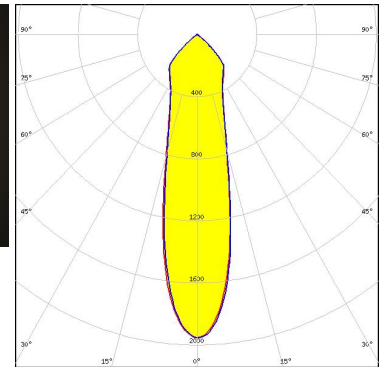
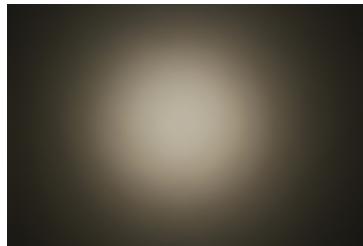

Light distribution files



LED VERO13
FWHM / FWTM 20.0° / 68.0°
Efficiency 93 %
Peak intensity 3 cd/lm
LEDs/each optic 1
Light colour/type White
Required components:
 C13658_CLAMP-VERO13-18

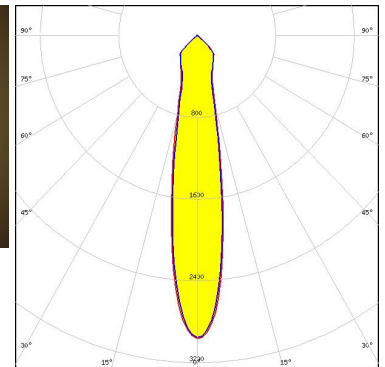

Light distribution files

OPTICAL RESULTS (MEASURED):



LED VERO13
FWHM / FWTM 25.0° / 92.0°
Efficiency 88 %
Peak intensity 1.8 cd/lm
LEDs/each optic 1
Light colour/type White
Required components:
 C13658_CLAMP-VERO13-18
 F13671_ANGE-RZ-LENS

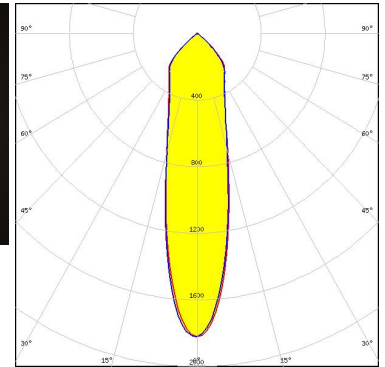

Light distribution files



LED VERO18
FWHM / FWTM 29.0° / 94.0°
Efficiency 89 %
Peak intensity 1.5 cd/lm
LEDs/each optic 1
Light colour/type White
Required components:
 C13658_CLAMP-VERO13-18
 F13671_ANGE-RZ-LENS

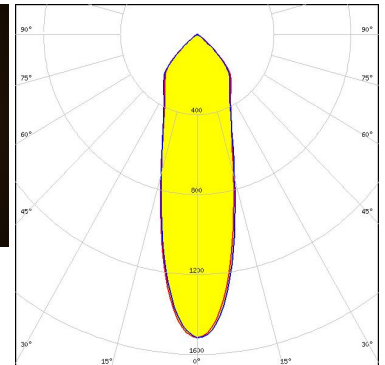
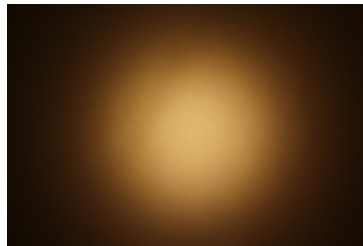

Light distribution files



LED VERO18
FWHM / FWTM 25.0° / 88.0°
Efficiency 92 %
Peak intensity 2.2 cd/lm
LEDs/each optic 1
Light colour/type White
Required components:
 C13658_CLAMP-VERO13-18

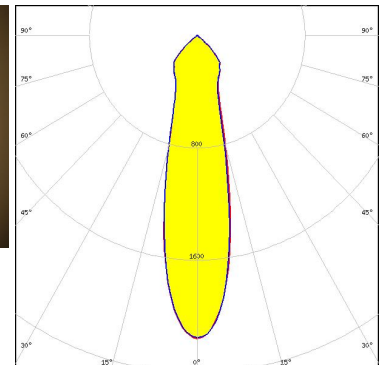

Light distribution files

OPTICAL RESULTS (MEASURED):



LED VERO29
FWHM / FWTM 44.0° / 99.0°
Efficiency 89 %
Peak intensity 1 cd/lm
LEDs/each optic 1
Light colour/type White
Required components:
 C13584_CLAMP-VERO29
 F13671_ANGE-RZ-LENS

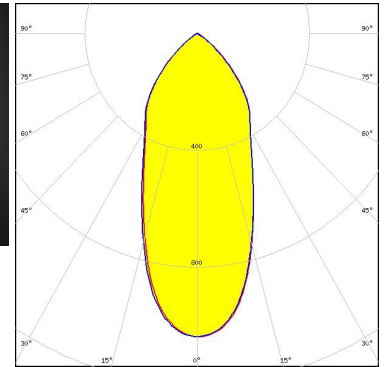
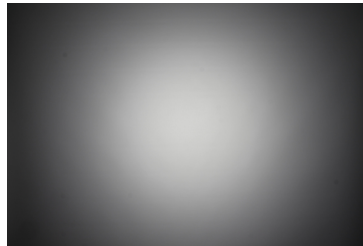

Light distribution files



LED VERO29
FWHM / FWTM 39.0° / 96.0°
Efficiency 90 %
Peak intensity 1.2 cd/lm
LEDs/each optic 1
Light colour/type White
Required components:
 C13584_CLAMP-VERO29

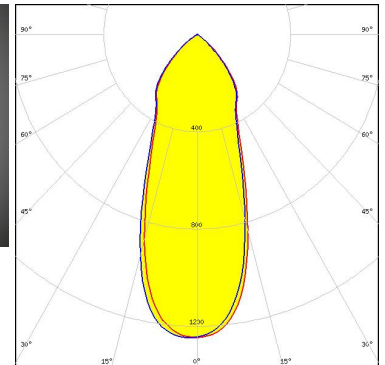
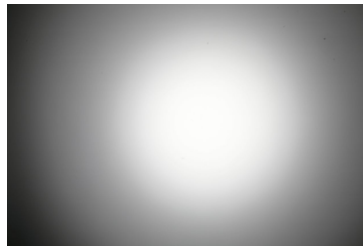

Light distribution files



LED Vesta TW 15mm DP
FWHM / FWTM 28.0° / 94.0°
Efficiency 89 %
Peak intensity 1.6 cd/lm
LEDs/each optic 1
Light colour/type Tunable White
Required components:
 C13658_CLAMP-VERO13-18
 F13671_ANGE-RZ-LENS
 Bender Wirth: 482 Typ L2

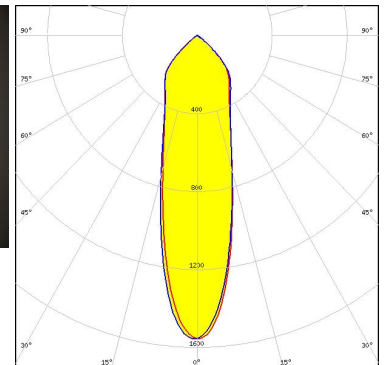
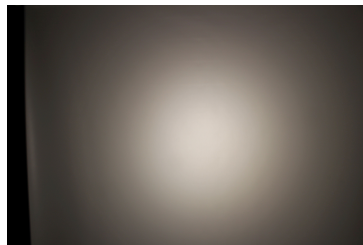

Light distribution files

OPTICAL RESULTS (MEASURED):



LED Vesta TW 15mm DP
FWHM / FWTM 24.0° / 90.0°
Efficiency 92 %
Peak intensity 2.1 cd/lm
LEDs/each optic 1
Light colour/type Tunable White
Required components:
 C13658_CLAMP-VERO13-18
 Bender Wirth: 482 Typ L2

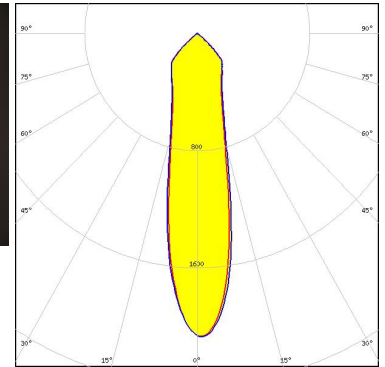
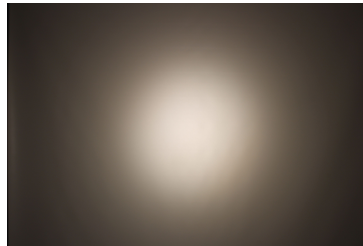

Light distribution files



LED Vesta TW 18mm (31W) DP
FWHM / FWTM 27.0° / 92.0°
Efficiency 94 %
Peak intensity 1.8 cd/lm
LEDs/each optic 1
Light colour/type Tunable White
Required components:
 C13584_CLAMP-VERO29
 Bender Wirth: 483 Typ L3

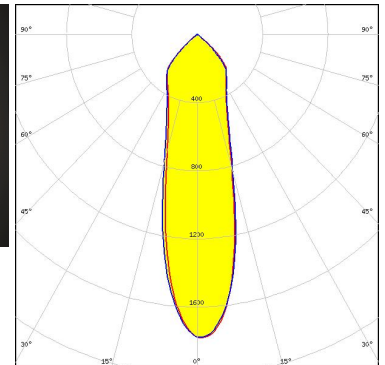
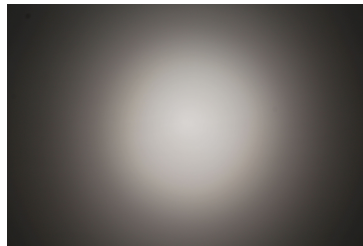

Light distribution files



LED Vesta TW 18mm (31W) DP
FWHM / FWTM 30.0° / 94.0°
Efficiency 89 %
Peak intensity 1.5 cd/lm
LEDs/each optic 1
Light colour/type Tunable White
Required components:
 C13584_CLAMP-VERO29
 F13671_ANGE-RZ-LENS
 Bender Wirth: 483 Typ L3

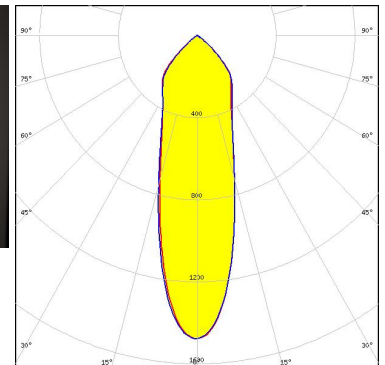
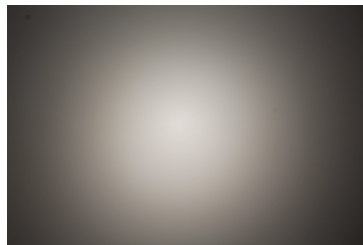

Light distribution files

OPTICAL RESULTS (MEASURED):



LED Vesta TW 22mm DP
FWHM / FWTM 30.0° / 93.0°
Efficiency 94 %
Peak intensity 1.6 cd/lm
LEDs/each optic 1
Light colour/type Tunable White
Required components:
 C13584_CLAMP-VERO29
 Bender Wirth: 494 Typ L3

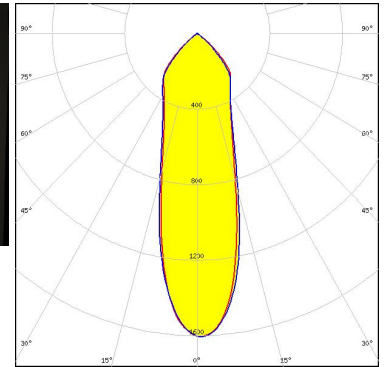
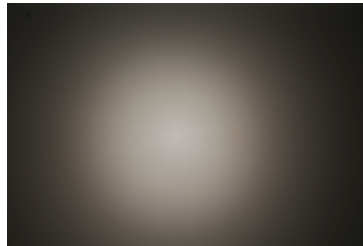

Light distribution files



LED Vesta TW 22mm DP
FWHM / FWTM 33.0° / 95.0°
Efficiency 89 %
Peak intensity 1.4 cd/lm
LEDs/each optic 1
Light colour/type Tunable White
Required components:
 C13584_CLAMP-VERO29
 F13671_ANGE-RZ-LENS
 Bender Wirth: 494 Typ L3

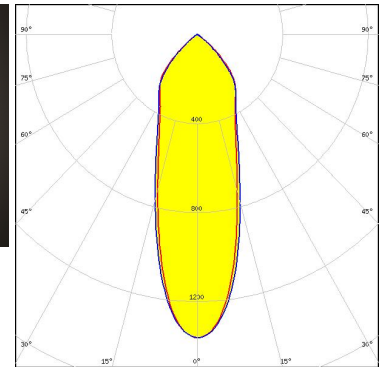
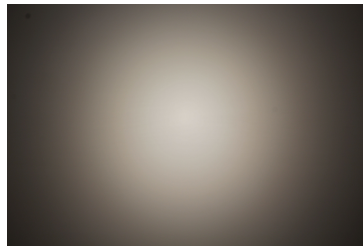

CITIZEN

LED CLL02x/CLU02x (LES10)
FWHM / FWTM 17.0° / 75.0°
Efficiency 93 %
Peak intensity 2.9 cd/lm
LEDs/each optic 1
Light colour/type White
Required components:
 C13658_CLAMP-VERO13-18
 Bender Wirth: 434 Typ L1

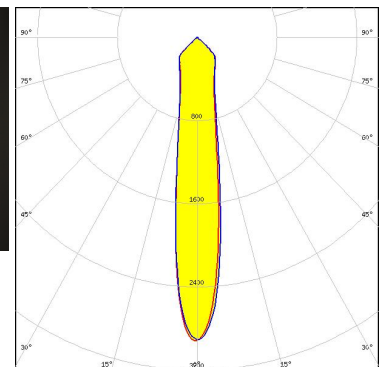
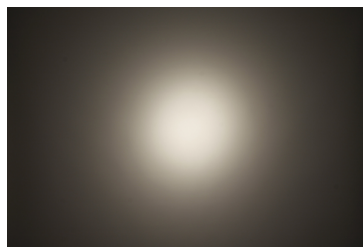

Light distribution files

OPTICAL RESULTS (MEASURED):

CITIZEN

LED CLL03x/CLU03x
FWHM / FWTM 23.0° / 90.0°
Efficiency 87 %
Peak intensity 1.8 cd/lm
LEDs/each optic 1
Light colour/type White
Required components:
F13671_ANGE-RZ-LENS
IDEAL: 50-2103CT + 50-2100AN

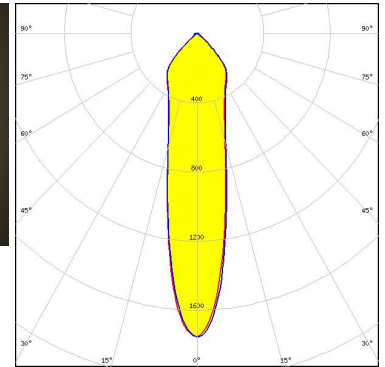
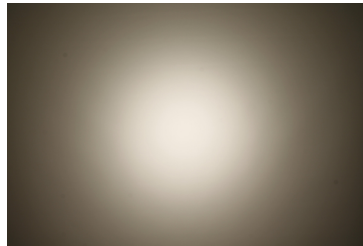

Light distribution files

CITIZEN

LED CLL03x/CLU03x
FWHM / FWTM 21.0° / 89.0°
Efficiency 92 %
Peak intensity 2.3 cd/lm
LEDs/each optic 1
Light colour/type White
Required components:
C13658_CLAMP-VERO13-18
Bender Wirth: 433 Typ L1

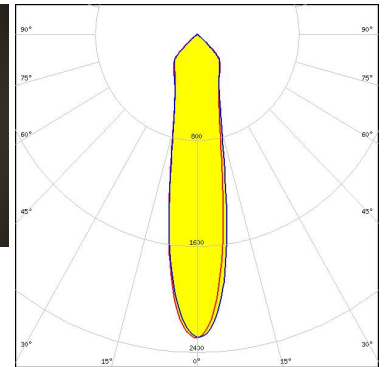
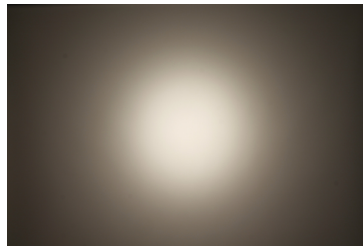

Light distribution files

CITIZEN

LED CLL03x/CLU03x
FWHM / FWTM 19.0° / 83.0°
Efficiency 94 %
Peak intensity 2.7 cd/lm
LEDs/each optic 1
Light colour/type White
Required components:
IDEAL: 50-2103CT + 50-2100AN

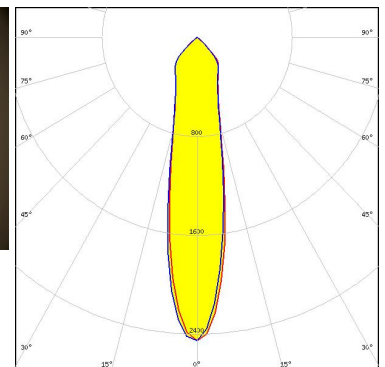
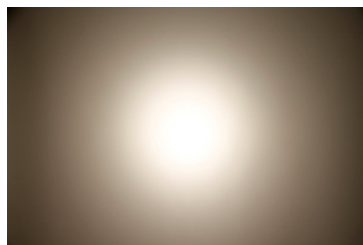

Light distribution files

OPTICAL RESULTS (MEASURED):

CITIZEN

LED CLL03x/CLU03x
 FWHM / FWTM 25.0° / 92.0°
 Efficiency 87 %
 Peak intensity 1.7 cd/lm
 LEDs/each optic 1
 Light colour/type White

Required components:

F13671_ANGE-RZ-LENS

TE Connectivity: 2213254-2 + OPTIC CLIP Z50 TYPE1 2213194-1

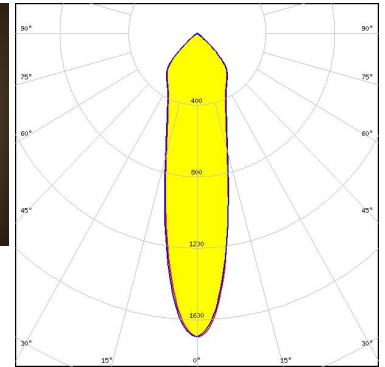
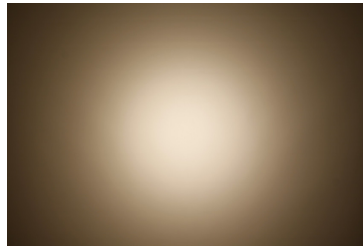

Light distribution files

CITIZEN

LED CLL03x/CLU03x
 FWHM / FWTM 20.0° / 88.0°
 Efficiency 94 %
 Peak intensity 2.5 cd/lm
 LEDs/each optic 1
 Light colour/type White

Required components:

C16791_CLAMP-Z45-A

TE Connectivity: 2325807-3

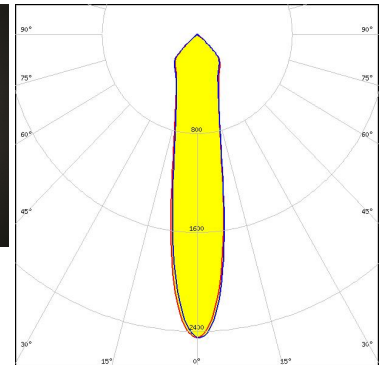
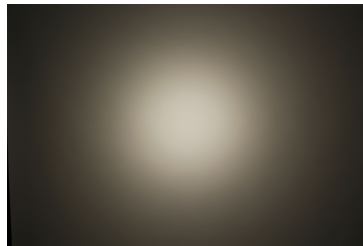

Light distribution files

CITIZEN

LED CLL03x/CLU03x
 FWHM / FWTM 22.0° / 87.0°
 Efficiency 94 %
 Peak intensity 2.5 cd/lm
 LEDs/each optic 1
 Light colour/type White

Required components:

TE Connectivity: 2213254-2 + OPTIC CLIP Z50 TYPE1 2213194-1

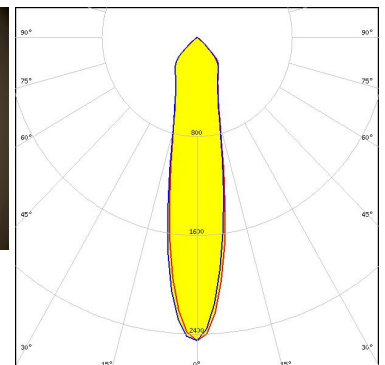
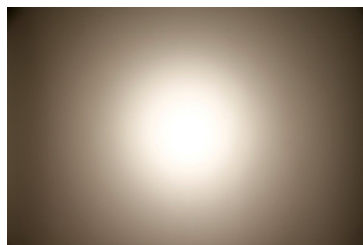

Light distribution files

OPTICAL RESULTS (MEASURED):

CITIZEN

LED CLL03x/CLU03x
 FWHM / FWTM 23.0° / 91.0°
 Efficiency 91 %
 Peak intensity 1.9 cd/lm
 LEDs/each optic 1
 Light colour/type White
 Required components:
 C16791_CLAMP-Z45-A
 F13671_ANGE-RZ-LENS
 TE Connectivity: 2325807-3

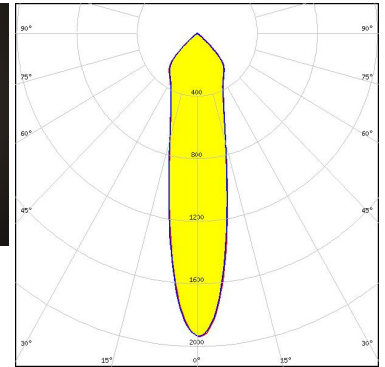

Light distribution files

CITIZEN

LED CLL04x/CLU04x
 FWHM / FWTM 33.0° / 93.0°
 Efficiency 88 %
 Peak intensity 1.3 cd/lm
 LEDs/each optic 1
 Light colour/type White
 Required components:
 F13671_ANGE-RZ-LENS
 IDEAL: 50-2204-CT + 50-2100AN

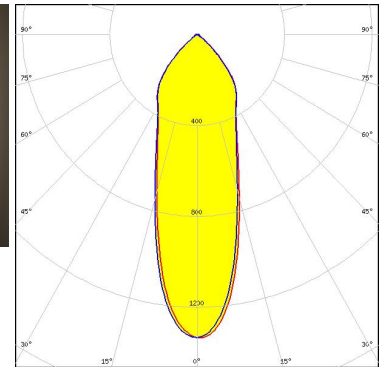

Light distribution files

CITIZEN

LED CLL04x/CLU04x
 FWHM / FWTM 30.0° / 91.0°
 Efficiency 92 %
 Peak intensity 1.6 cd/lm
 LEDs/each optic 1
 Light colour/type White
 Required components:
 IDEAL: 50-2204-CT + 50-2100AN

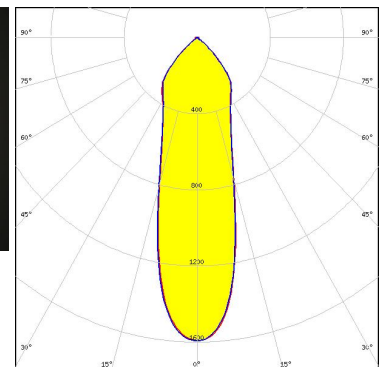
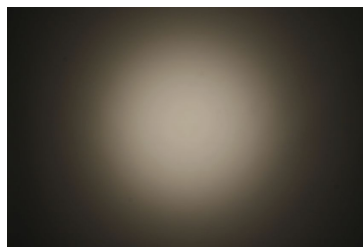

Light distribution files

OPTICAL RESULTS (MEASURED):

CITIZEN

LED CLL04x/CLU04x
 FWHM / FWTM 29.0° / 91.0°
 Efficiency 93 %
 Peak intensity 1.7 cd/lm
 LEDs/each optic 1
 Light colour/type White
 Required components:
 C13584_CLAMP-VERO29
 Bender Wirth: 431 Typ L3

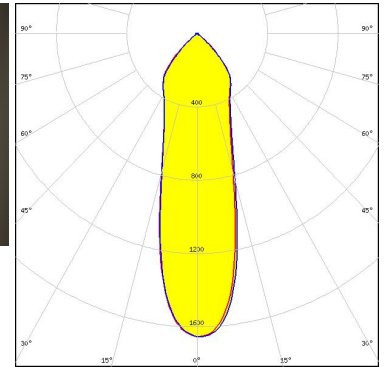
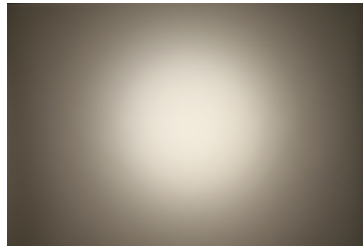

Light distribution files

CITIZEN

LED CLU700/701/702/703
 FWHM / FWTM 14.0° / 56.0°
 Efficiency 93 %
 Peak intensity 3.7 cd/lm
 LEDs/each optic 1
 Light colour/type White
 Required components:
 C13658_CLAMP-VERO13-18
 Bender Wirth: 434 Typ L1

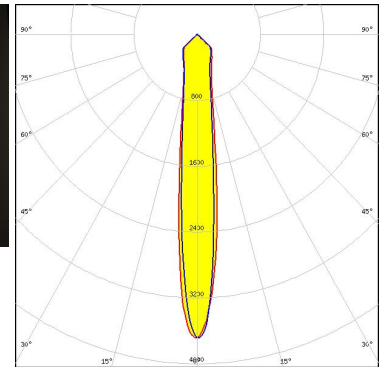

Light distribution files

CITIZEN

LED CLU720/721/723
 FWHM / FWTM 17.0° / 84.0°
 Efficiency 94 %
 Peak intensity 2.7 cd/lm
 LEDs/each optic 1
 Light colour/type White
 Required components:
 TE Connectivity: 2213254-2 + OPTIC CLIP Z50 TYPE1 2213194-1

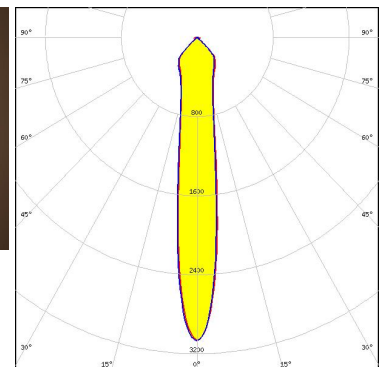
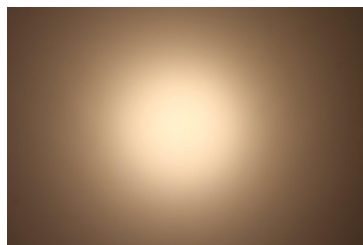

Light distribution files

OPTICAL RESULTS (MEASURED):

CITIZEN

LED CLU720/721/723
FWHM / FWTM 18.0° / 81.0°
Efficiency 92 %
Peak intensity 2.7 cd/lm
LEDs/each optic 1
Light colour/type White
Required components:
C13658_CLAMP-VERO13-18

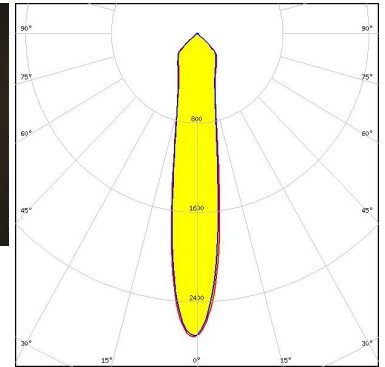

Light distribution files

CITIZEN

LED CLU720/721/723
FWHM / FWTM 15.0° / 75.0°
Efficiency 94 %
Peak intensity 3.1 cd/lm
LEDs/each optic 1
Light colour/type White
Required components:
IDEAL: 50-2103CT + 50-2100AN

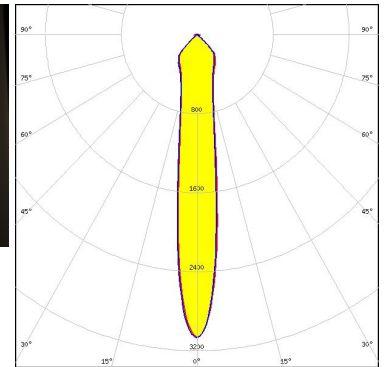

Light distribution files

CITIZEN

LED CLU730/731/733
FWHM / FWTM 18.0° / 84.0°
Efficiency 92 %
Peak intensity 2.7 cd/lm
LEDs/each optic 1
Light colour/type White
Required components:
IDEAL: 50-2204-CT + 50-2100AN

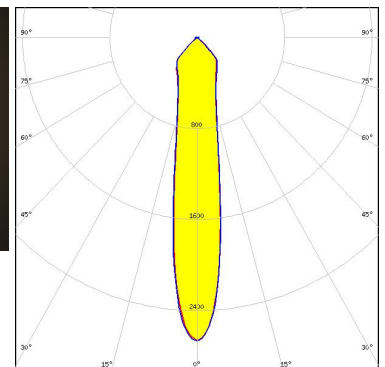
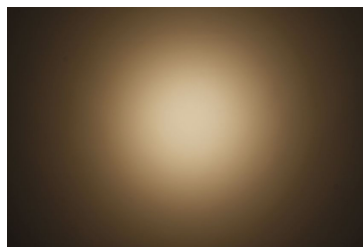

Light distribution files

OPTICAL RESULTS (MEASURED):

CITIZEN

LED CLU730/731/733
 FWHM / FWTM 21.0° / 88.0°
 Efficiency 87 %
 Peak intensity 2.1 cd/lm
 LEDs/each optic 1
 Light colour/type White
 Required components:
 F13671_ANGE-RZ-LENS
 IDEAL: 50-2204-CT + 50-2100AN

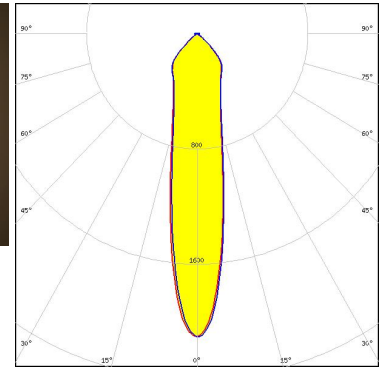
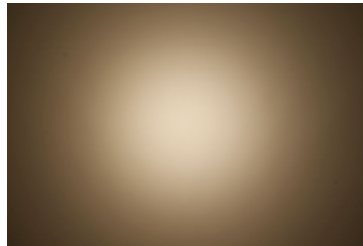

Light distribution files

CITIZEN

LED CLU730/731/733
 FWHM / FWTM 18.0° / 84.0°
 Efficiency 92 %
 Peak intensity 2.7 cd/lm
 LEDs/each optic 1
 Light colour/type White
 Required components:
 IDEAL: 50-2204-CT + 50-2100AN

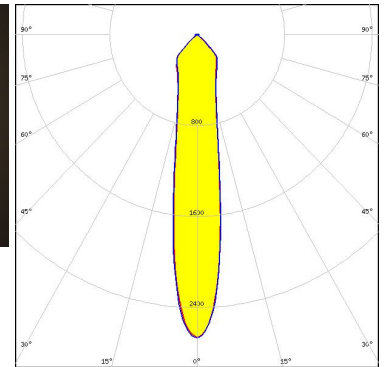
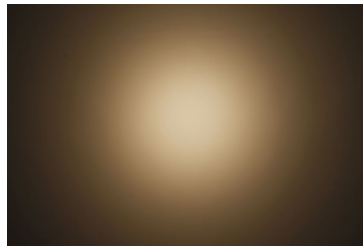

Light distribution files



LED CMA1840
 FWHM / FWTM 22.0° / 88.0°
 Efficiency 95 %
 Peak intensity 2.5 cd/lm
 LEDs/each optic 1
 Light colour/type White
 Required components:
 C14123_CLAMP-CXA15-18

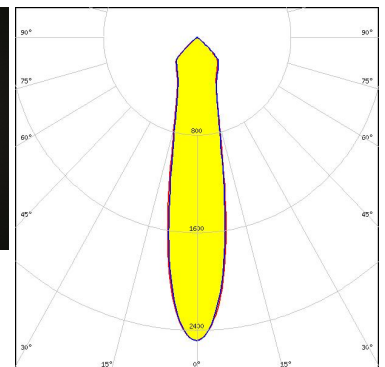
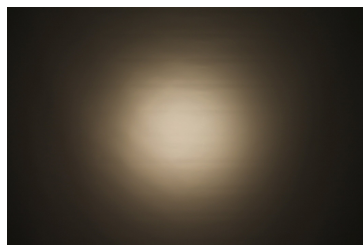

Light distribution files

OPTICAL RESULTS (MEASURED):



LED CMA2550
 FWHM / FWTM 26.0° / 90.0°
 Efficiency 94 %
 Peak intensity 2 cd/lm
 LEDs/each optic 1
 Light colour/type White
 Required components:
 C14036_CLAMP_CXA25-30

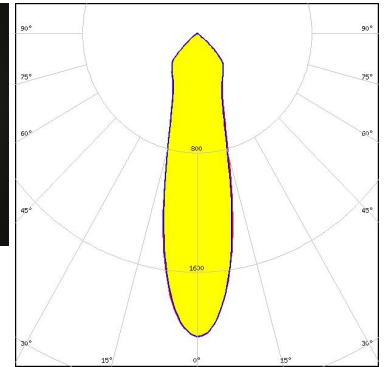
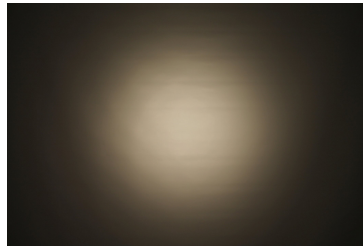

Light distribution files



LED CMA3090
 FWHM / FWTM 30.0° / 92.0°
 Efficiency 94 %
 Peak intensity 1.7 cd/lm
 LEDs/each optic 1
 Light colour/type White
 Required components:
 C14036_CLAMP_CXA25-30

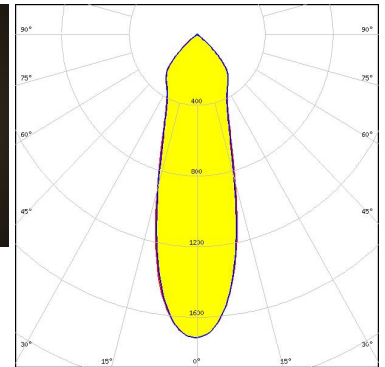
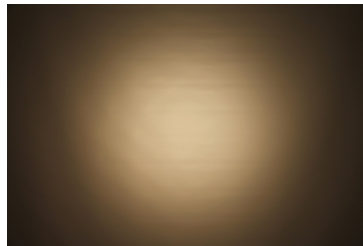

Light distribution files



LED CMT14xx
 FWHM / FWTM 17.0° / 65.0°
 Efficiency 94 %
 Peak intensity 3.2 cd/lm
 LEDs/each optic 1
 Light colour/type White
 Required components:
 C13658_CLAMP-VERO13-18
 Bender Wirth: 434 Typ L1

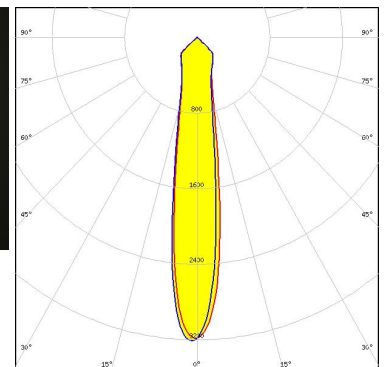
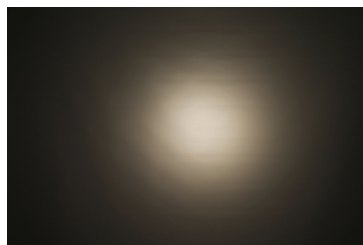

Light distribution files

OPTICAL RESULTS (MEASURED):



LED CMT19xx
FWHM / FWTM 21.0° / 85.0°
Efficiency 94 %
Peak intensity 2.6 cd/lm
LEDs/each optic 1
Light colour/type White
Required components:
C13658_CLAMP-VERO13-18
Bender Wirth: 477 Typ L1

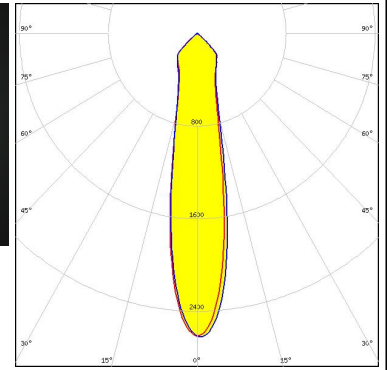

Light distribution files



LED CMT28xx
FWHM / FWTM 29.0° / 91.0°
Efficiency 94 %
Peak intensity 1.8 cd/lm
LEDs/each optic 1
Light colour/type White
Required components:
C13584_CLAMP-VERO29
Bender Wirth: 471 Typ L3

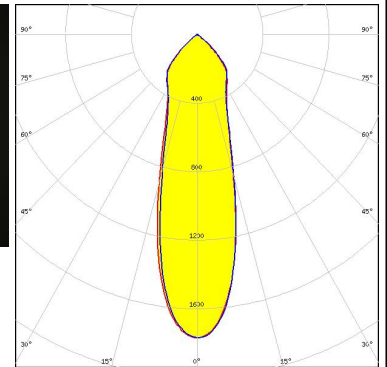

Light distribution files



LED CXA/B 15xx
FWHM / FWTM 15.0° / 65.0°
Efficiency 93 %
Peak intensity 3.3 cd/lm
LEDs/each optic 1
Light colour/type White
Required components:
C13658_CLAMP-VERO13-18
Bender Wirth: 441 Typ L1

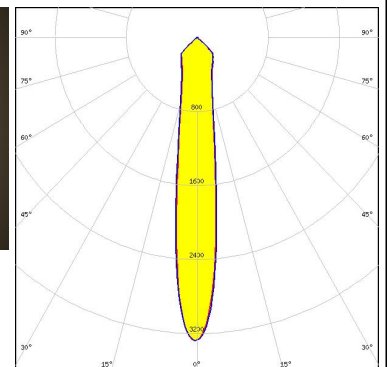
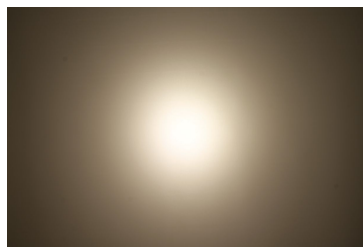

Light distribution files

OPTICAL RESULTS (MEASURED):



LED CXA/B 15xx
 FWHM / FWTM 20.0° / 81.0°
 Efficiency 94 %
 Peak intensity 2.8 cd/lm
 LEDs/each optic 1
 Light colour/type White
 Required components:
 C14123_CLAMP-CXA15-18

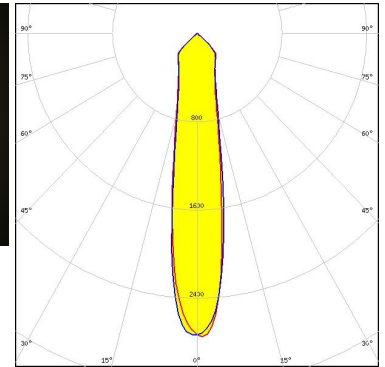

Light distribution files



LED CXA/B 1816 & CXA/B 1820 & CXA 1850
 FWHM / FWTM 22.0° / 89.0°
 Efficiency 94 %
 Peak intensity 2.4 cd/lm
 LEDs/each optic 1
 Light colour/type White
 Required components:
 C14123_CLAMP-CXA15-18

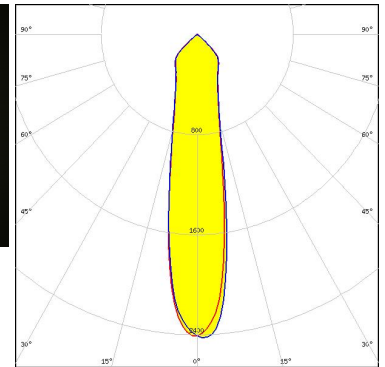

Light distribution files



LED CXA/B 1816 & CXA/B 1820 & CXA 1850
 FWHM / FWTM 19.0° / 83.0°
 Efficiency 93 %
 Peak intensity 2.7 cd/lm
 LEDs/each optic 1
 Light colour/type White
 Required components:
 TE Connectivity: 2213401-2 + OPTIC CLIP Z50 TYPE1 2213194-1

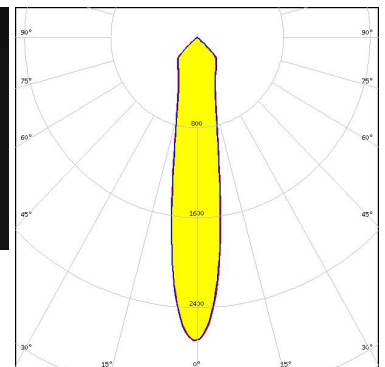

Light distribution files

OPTICAL RESULTS (MEASURED):



LED CXA/B 1816 & CXA/B 1820 & CXA 1850
 FWHM / FWTM 19.0° / 87.0°
 Efficiency 93 %
 Peak intensity 2.5 cd/lm
 LEDs/each optic 1
 Light colour/type White
 Required components:
 C13658_CLAMP-VERO13-18
 Bender Wirth: 437 Typ L1

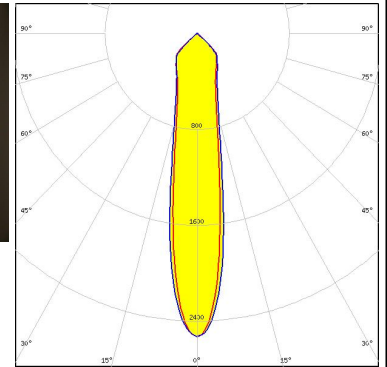
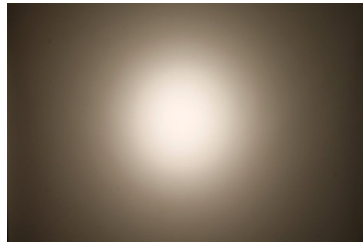

Light distribution files



LED CXA/B 1816 & CXA/B 1820 & CXA 1850
 FWHM / FWTM 22.0° / 90.0°
 Efficiency 89 %
 Peak intensity 2 cd/lm
 LEDs/each optic 1
 Light colour/type White
 Required components:
 F13671_ANGE-RZ-LENS
 TE Connectivity: 2213401-2 + OPTIC CLIP Z50 TYPE1 2213194-1

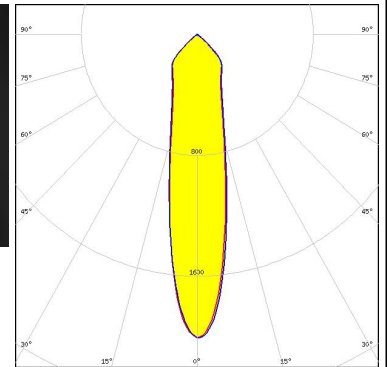
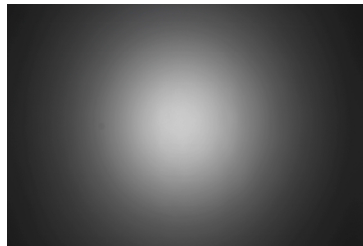

Light distribution files



LED CXA/B 1816 & CXA/B 1820 & CXA 1850
 FWHM / FWTM 16.0° / 68.0°
 Efficiency 94 %
 Peak intensity 3.3 cd/lm
 LEDs/each optic 1
 Light colour/type White
 Required components:
 IDEAL: 50-2101CR + 50-2100AN

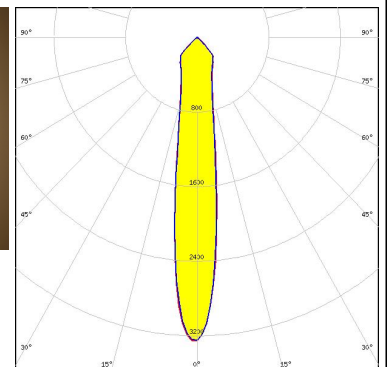
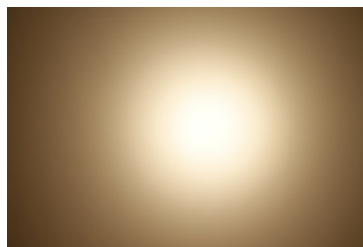

Light distribution files

OPTICAL RESULTS (MEASURED):



LED CXA/B 25xx
 FWHM / FWTM 22.0° / 87.0°
 Efficiency 94 %
 Peak intensity 2.3 cd/lm
 LEDs/each optic 1
 Light colour/type White
 Required components:
 IDEAL: 50-2102CR + 50-2100AN

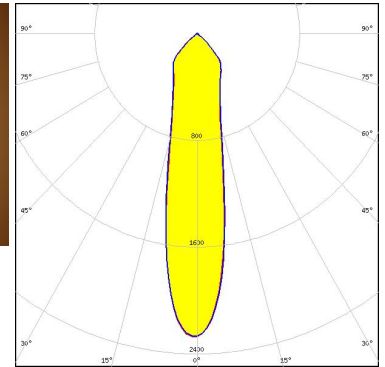
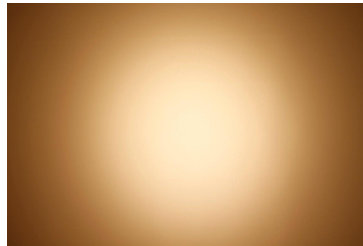

Light distribution files



LED CXA/B 25xx
 FWHM / FWTM 25.0° / 92.0°
 Efficiency 93 %
 Peak intensity 1.9 cd/lm
 LEDs/each optic 1
 Light colour/type White
 Required components:
 C14036_CLAMP_CXA25-30

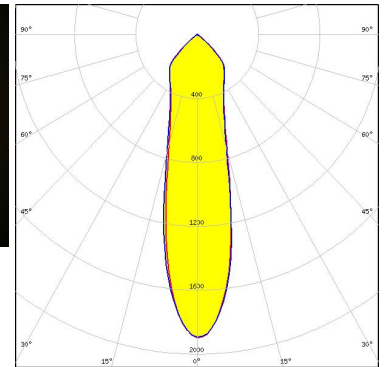

Light distribution files



LED CXA/B 30xx
 FWHM / FWTM 32.0° / 95.0°
 Efficiency 92 %
 Peak intensity 1.5 cd/lm
 LEDs/each optic 1
 Light colour/type White
 Required components:
 C14036_CLAMP_CXA25-30

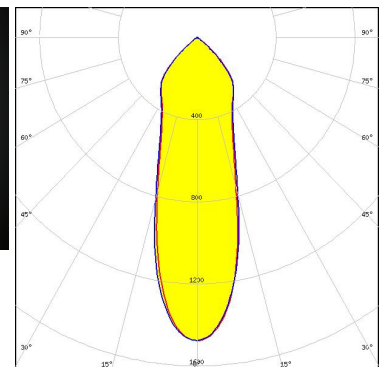
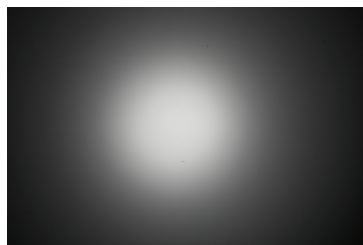

Light distribution files

OPTICAL RESULTS (MEASURED):



LED CXA/B 30xx
 FWHM / FWTM 28.0° / 89.0°
 Efficiency 94 %
 Peak intensity 1.7 cd/lm
 LEDs/each optic 1
 Light colour/type White
 Required components:
 IDEAL: 50-2234C + 50-2100AN

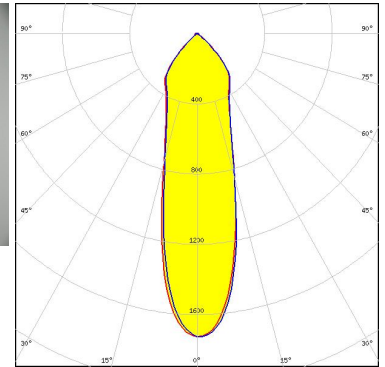
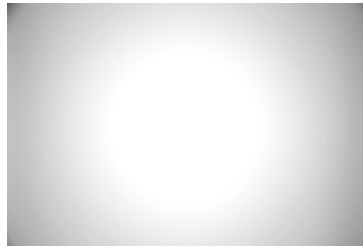

Light distribution files



LED CXA/B 3590
 FWHM / FWTM 40.0° / 97.0°
 Efficiency 93 %
 Peak intensity 1.2 cd/lm
 LEDs/each optic 1
 Light colour/type White
 Required components:
 IDEAL: 50-2303CR + 50-2300AN

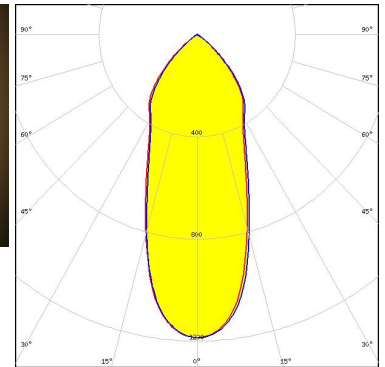
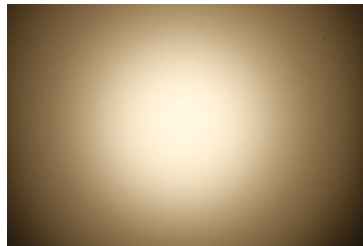

Light distribution files



LED CHI3030 19W
 FWHM / FWTM 29.0° / 90.0°
 Efficiency 88 %
 Peak intensity 1.5 cd/lm
 LEDs/each optic 1
 Light colour/type White
 Required components:
 C13584_CLAMP-VERO29
 F13671_ANGE-RZ-LENS
 Bender Wirth: 468 Typ L3

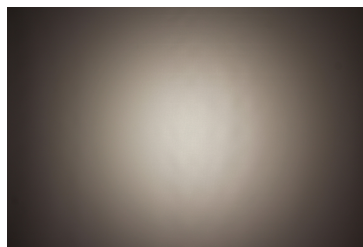

Light distribution files

OPTICAL RESULTS (MEASURED):

EVERLIGHT

LED CHI3030 29W
FWHM / FWTM 39.0° / 90.0°
Efficiency 88 %
Peak intensity 1.3 cd/lm
LEDs/each optic 1
Light colour/type White

Required components:

C13584_CLAMP-VERO29
F13671_ANGE-RZ-LENS
Bender Wirth: 468 Typ L3

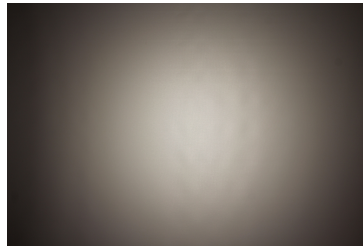

Light distribution files

LUMILEDS

LED LUXEON CoB 1202/1203
FWHM / FWTM 18.0° / 83.0°
Efficiency 93 %
Peak intensity 2.8 cd/lm
LEDs/each optic 1
Light colour/type White

Required components:

C13658_CLAMP-VERO13-18
Bender Wirth: 438 Typ L1

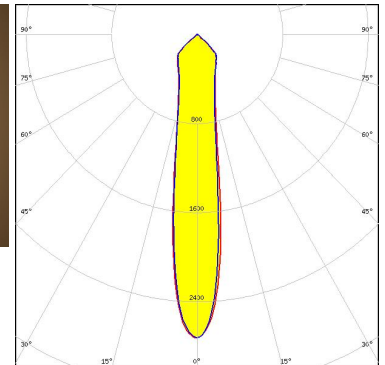
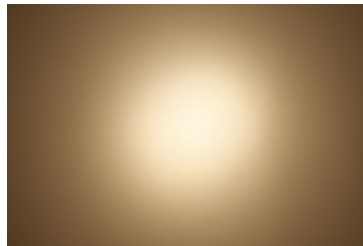

Light distribution files

LUMILEDS

LED LUXEON CoB 1204/1205
FWHM / FWTM 19.0° / 68.0°
Efficiency 94 %
Peak intensity 3.1 cd/lm
LEDs/each optic 1
Light colour/type White

Required components:

TE Connectivity: 2213130-2 + OPTIC CLIP Z50 TYPE1 2213194-1

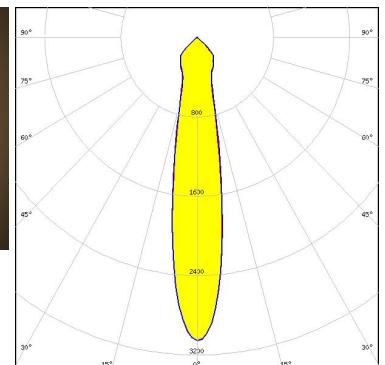

Light distribution files

OPTICAL RESULTS (MEASURED):



LED LUXEON CoB 1204/1205
FWHM / FWTM 17.0° / 76.0°
Efficiency 94 %
Peak intensity 3 cd/lm
LEDs/each optic 1
Light colour/type White
Required components:
IDEAL: 50-2100SH + 50-2100AN

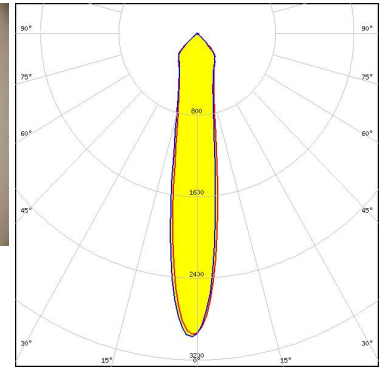
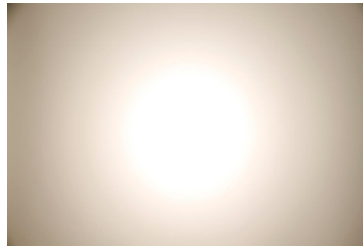

Light distribution files



LED LUXEON CoB 1204HD
FWHM / FWTM 15.0° / 53.0°
Efficiency 95 %
Peak intensity 3.7 cd/lm
LEDs/each optic 1
Light colour/type White
Required components:
TE Connectivity: 2213382-2 + OPTIC CLIP Z50 TYPE1 2213194-1

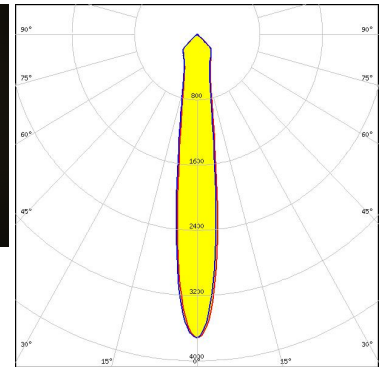
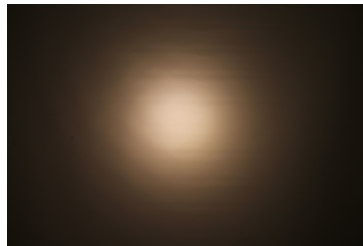

Light distribution files



LED LUXEON CoB 1205HD
FWHM / FWTM 17.0° / 65.0°
Efficiency 95 %
Peak intensity 3.3 cd/lm
LEDs/each optic 1
Light colour/type White
Required components:
TE Connectivity: 2213382-2 + OPTIC CLIP Z50 TYPE1 2213194-1

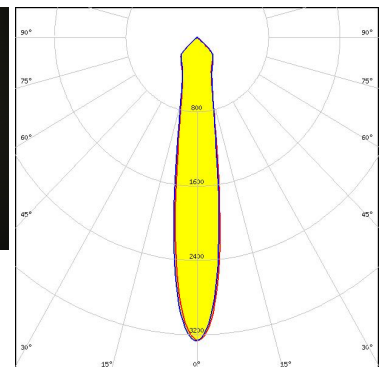
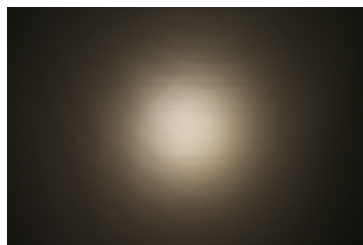

Light distribution files

OPTICAL RESULTS (MEASURED):



LED LUXEON CoB 1208
 FWHM / FWTM 20.0° / 84.0°
 Efficiency 94 %
 Peak intensity 2.6 cd/lm
 LEDs/each optic 1
 Light colour/type White
 Required components:
 IDEAL: 50-2100SH + 50-2100AN

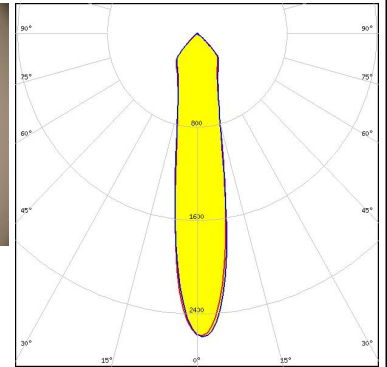
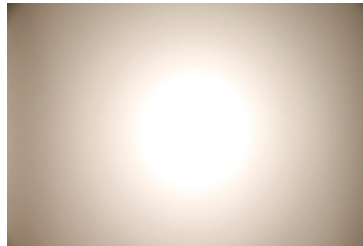

Light distribution files



LED LUXEON CoB 1208
 FWHM / FWTM 23.0° / 89.0°
 Efficiency 88 %
 Peak intensity 1.9 cd/lm
 LEDs/each optic 1
 Light colour/type White
 Required components:
 F13671_ANGE-RZ-LENS
 IDEAL: 50-2100SH + 50-2100AN

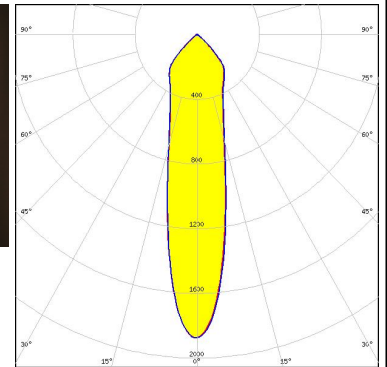
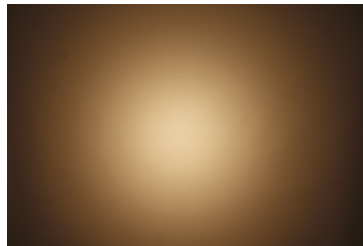

Light distribution files



LED LUXEON CoB 1208
 FWHM / FWTM 21.0° / 79.0°
 Efficiency 93 %
 Peak intensity 2.7 cd/lm
 LEDs/each optic 1
 Light colour/type White
 Required components:
 TE Connectivity: 2213130-2 + OPTIC CLIP Z50 TYPE1 2213194-1

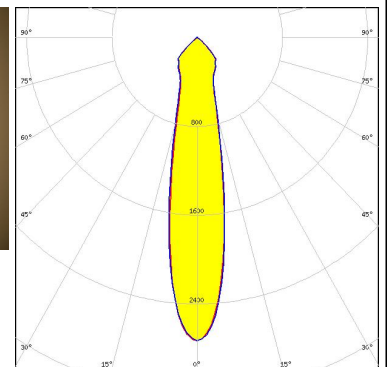

Light distribution files

OPTICAL RESULTS (MEASURED):



LED LUXEON CoB 1208

FWHM / FWTM 25.0° / 92.0°

Efficiency 87 %

Peak intensity 1.7 cd/lm

LEDs/each optic 1

Light colour/type White

Required components:

F13671_ANGE-RZ-LENS

TE Connectivity: 2213130-2 + OPTIC CLIP Z50 TYPE1 2213194-1

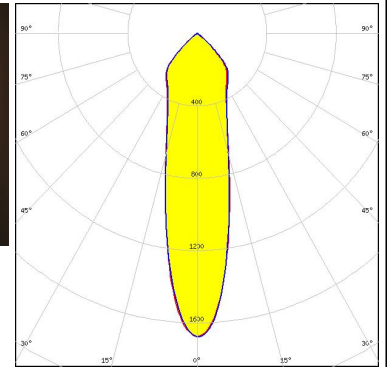
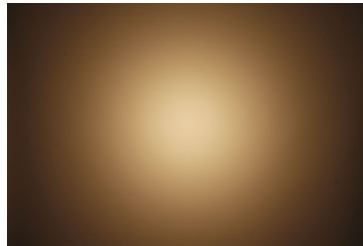

Light distribution files



LED LUXEON CoB 1211

FWHM / FWTM 26.0° / 91.0°

Efficiency 94 %

Peak intensity 1.9 cd/lm

LEDs/each optic 1

Light colour/type White

Required components:

C13584_CLAMP-VERO29

Bender Wirth: 431 Typ L3

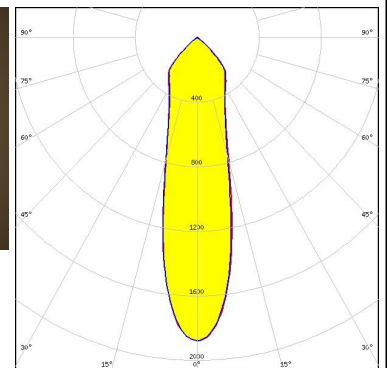
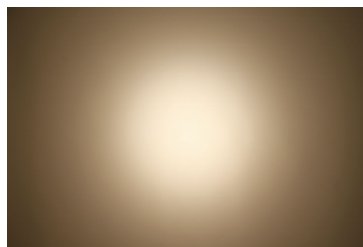

Light distribution files



LED LUXEON CoB 1211

FWHM / FWTM 30.0° / 93.0°

Efficiency 87 %

Peak intensity 1.4 cd/lm

LEDs/each optic 1

Light colour/type White

Required components:

F13671_ANGE-RZ-LENS

IDEAL: 50-2204-CT + 50-2100AN

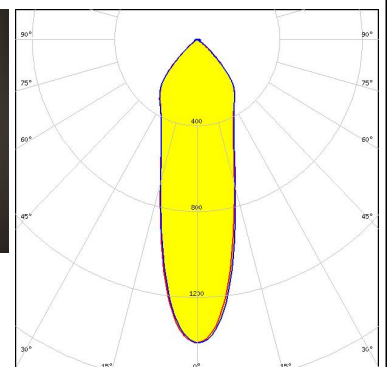
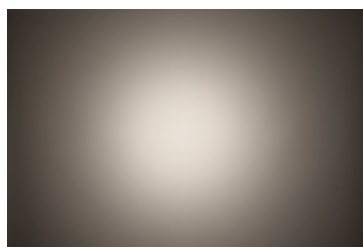

Light distribution files

OPTICAL RESULTS (MEASURED):



LED LUXEON CoB 1211
 FWHM / FWTM 26.0° / 91.0°
 Efficiency 91 %
 Peak intensity 1.7 cd/lm
 LEDs/each optic 1
 Light colour/type White
 Required components:
 IDEAL: 50-2204-CT + 50-2100AN

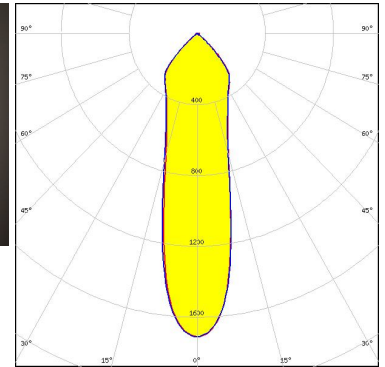

Light distribution files



LED LUXEON CoB 1213/1216/1812
 FWHM / FWTM 31.0° / 93.0°
 Efficiency 91 %
 Peak intensity 1.4 cd/lm
 LEDs/each optic 1
 Light colour/type White
 Required components:
 IDEAL: 50-2204-CT + 50-2100AN

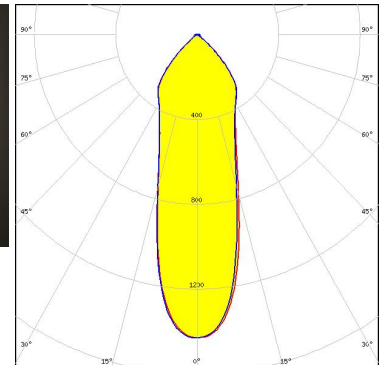
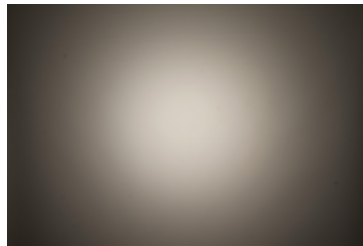

Light distribution files



LED LUXEON CoB 1213/1216/1812
 FWHM / FWTM 34.0° / 95.0°
 Efficiency 87 %
 Peak intensity 1.2 cd/lm
 LEDs/each optic 1
 Light colour/type White
 Required components:
 F13671_ANGE-RZ-LENS
 IDEAL: 50-2204CT + 50-2100LN

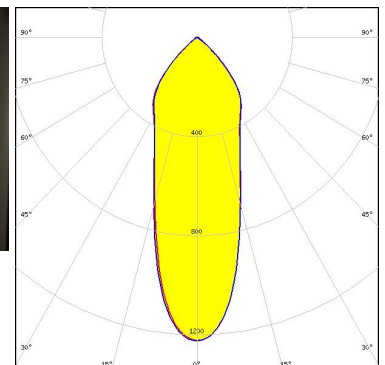

Light distribution files

OPTICAL RESULTS (MEASURED):



LED LUXEON K12
 FWHM / FWTM 20.0° / 86.0°
 Efficiency 94 %
 Peak intensity 2.7 cd/m
 LEDs/each optic 1
 Light colour/type White

Required components:

TE Connectivity: 2213134-2 + OPTIC CLIP Z50 TYPE1 2213194-1

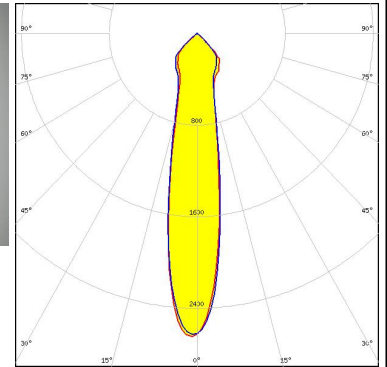
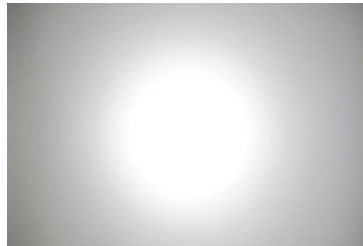

Light distribution files



LED LUXEON K12
 FWHM / FWTM 25.0° / 93.0°
 Efficiency 89 %
 Peak intensity 1.8 cd/m
 LEDs/each optic 1
 Light colour/type White

Required components:

F13671_ANGE-RZ-LENS
 TE Connectivity: 2213134-2 + OPTIC CLIP Z50 TYPE1 2213194-1

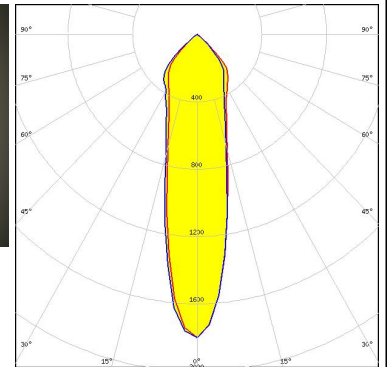
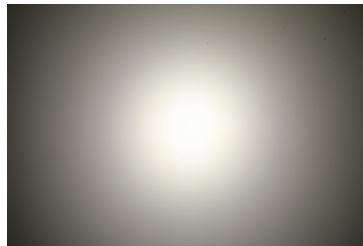

Light distribution files



LED LUXEON K16
 FWHM / FWTM 26.0° / 92.0°
 Efficiency 89 %
 Peak intensity 1.8 cd/m
 LEDs/each optic 1
 Light colour/type White

Required components:

F13671_ANGE-RZ-LENS
 TE Connectivity: 2213134-2 + OPTIC CLIP Z50 TYPE1 2213194-1

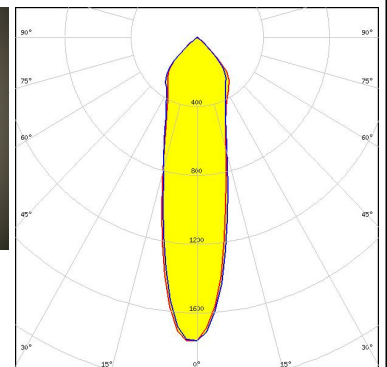
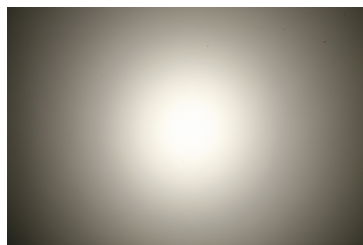

Light distribution files

OPTICAL RESULTS (MEASURED):



LED LUXEON K16
FWHM / FWTM 22.0° / 90.0°
Efficiency 94 %
Peak intensity 2.3 cd/lm
LEDs/each optic 1
Light colour/type White

Required components:

TE Connectivity: 2213134-2 + OPTIC CLIP Z50 TYPE1 2213194-1

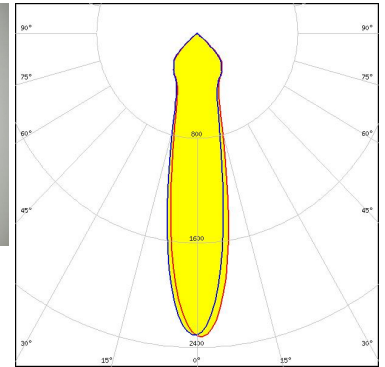
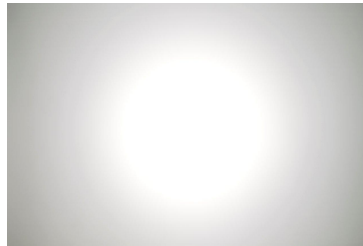

Light distribution files



LED LUXEON S2000
FWHM / FWTM 17.0° / 55.0°
Efficiency 93 %
Peak intensity 3.6 cd/lm
LEDs/each optic 1
Light colour/type White

Required components:

C13395_CLAMP-S2000

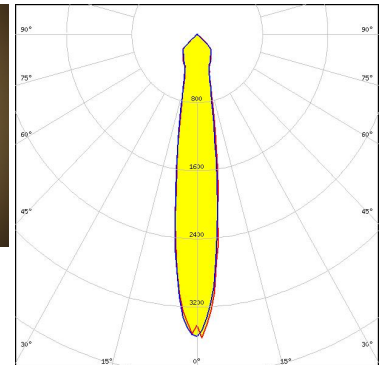

Light distribution files



LED LUXEON S3000
FWHM / FWTM 18.0° / 65.0°
Efficiency 92 %
Peak intensity 3.2 cd/lm
LEDs/each optic 1
Light colour/type White

Required components:

C13397_CLAMP-S3000

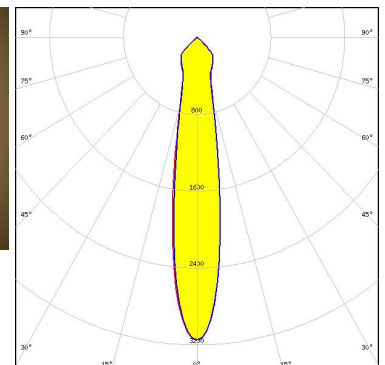

Light distribution files

OPTICAL RESULTS (MEASURED):



LED LUXEON S5000
FWHM / FWTM 22.0° / 86.0°
Efficiency 93 %
Peak intensity 2.5 cd/lm
LEDs/each optic 1
Light colour/type White
Required components:
C13399_CLAMP-S5000

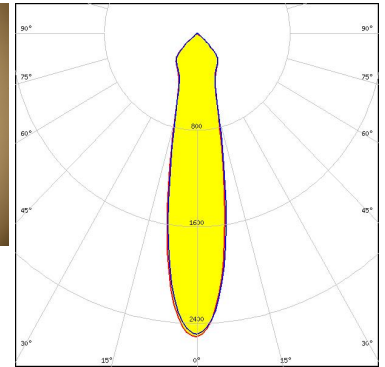

Light distribution files



LED CDM-14 (Dim-To-Warm)
FWHM / FWTM 23.0° / 89.0°
Efficiency 89 %
Peak intensity 2.1 cd/lm
LEDs/each optic 1
Light colour/type White
Required components:
C13658_CLAMP-VERO13-18
F13671_ANGE-RZ-LENS
Bender Wirth: 491 Typ L2

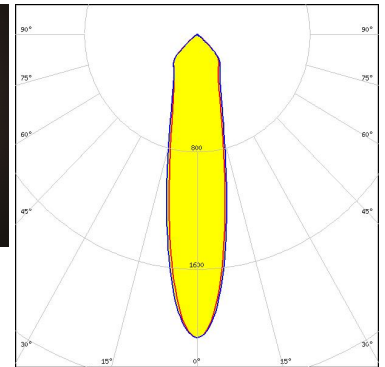
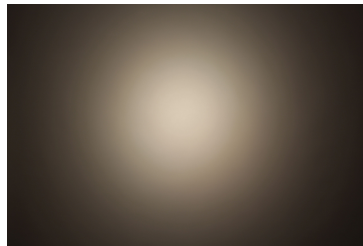

Light distribution files



LED CDM-14 (Dim-To-Warm)
FWHM / FWTM 20.0° / 80.0°
Efficiency 93 %
Peak intensity 2.6 cd/lm
LEDs/each optic 1
Light colour/type White
Required components:
C13658_CLAMP-VERO13-18
Bender Wirth: 491 Typ L2

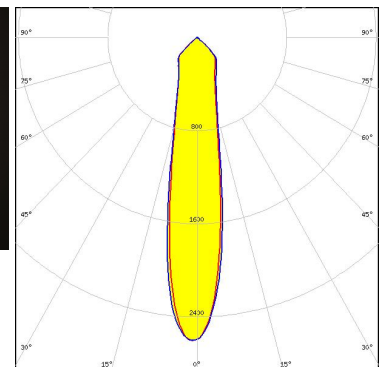
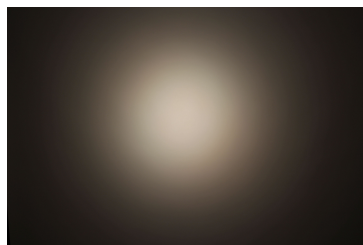

Light distribution files

OPTICAL RESULTS (MEASURED):



LED CDM-18 (Dim-To-Warm)
FWHM / FWTM 26.0° / 91.0°
Efficiency 89 %
Peak intensity 1.8 cd/lm
LEDs/each optic 1
Light colour/type White
Required components:
 C13658_CLAMP-VERO13-18
 F13671_ANGE-RZ-LENS
 Bender Wirth: 491 Typ L2

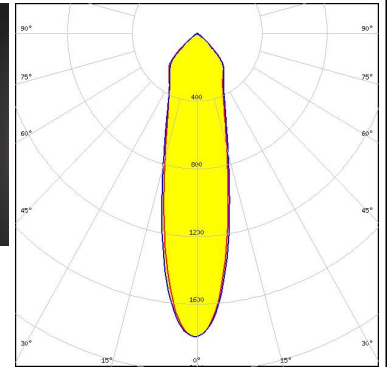

Light distribution files



LED CDM-18 (Dim-To-Warm)
FWHM / FWTM 24.0° / 89.0°
Efficiency 93 %
Peak intensity 2.2 cd/lm
LEDs/each optic 1
Light colour/type White
Required components:
 C13658_CLAMP-VERO13-18
 Bender Wirth: 491 Typ L2

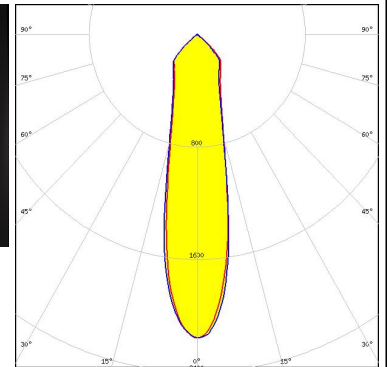

Light distribution files



LED CDM-9 (Dim-To-Warm)
FWHM / FWTM 18.0° / 81.0°
Efficiency 92 %
Peak intensity 2.7 cd/lm
LEDs/each optic 1
Light colour/type White
Required components:
 C13658_CLAMP-VERO13-18
 Bender Wirth: 490 Typ L1

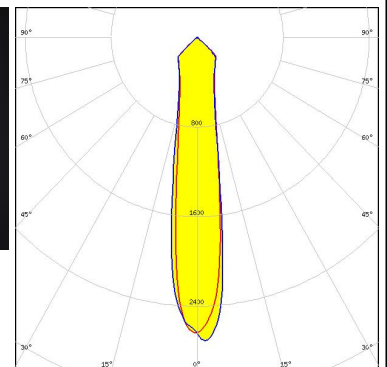
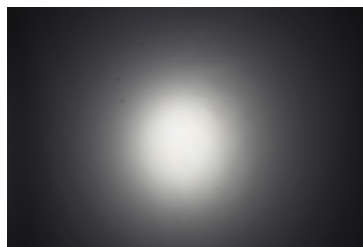

Light distribution files

OPTICAL RESULTS (MEASURED):



LED CDM-9 (Dim-To-Warm)
 FWHM / FWTM 21.0° / 91.0°
 Efficiency 87 %
 Peak intensity 2.1 cd/lm
 LEDs/each optic 1
 Light colour/type White

Required components:

C13658_CLAMP-VERO13-18
 F13671_ANGE-RZ-LENS
 Bender Wirth: 490 Typ L1

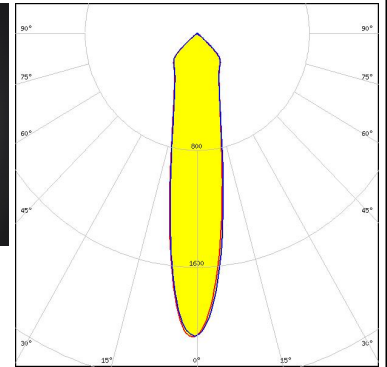

Light distribution files



LED CTM-14 (Tunable White)
 FWHM / FWTM 23.0° / 90.0°
 Efficiency 88 %
 Peak intensity 2 cd/lm
 LEDs/each optic 1
 Light colour/type White

Required components:

C13584_CLAMP-VERO29
 F13671_ANGE-RZ-LENS
 Bender Wirth: 442 Typ L3

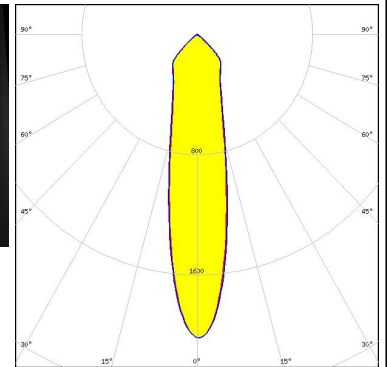

Light distribution files



LED CTM-14 (Tunable White)
 FWHM / FWTM 20.0° / 86.0°
 Efficiency 93 %
 Peak intensity 2.6 cd/lm
 LEDs/each optic 1
 Light colour/type White

Required components:

C13584_CLAMP-VERO29
 Bender Wirth: 442 Typ L3

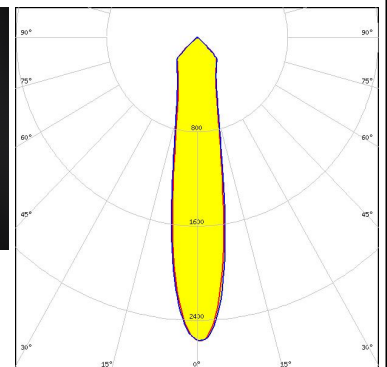
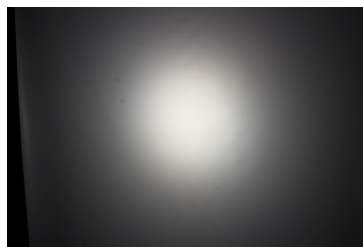

Light distribution files

OPTICAL RESULTS (MEASURED):



LED CTM-14 RGBW
FWHM / FWTM 22.0° / 87.0°
Efficiency 90 %
Peak intensity 2.2 cd/lm
LEDs/each optic 1
Light colour/type RGBW
Required components:
 C13584_CLAMP-VERO29
 F13671_ANGE-RZ-LENS
 Bender Wirth: 500 Typ L3-1

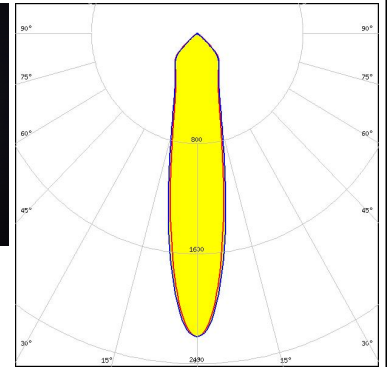

Light distribution files



LED CTM-14 RGBW
FWHM / FWTM 18.0° / 62.0°
Efficiency 94 %
Peak intensity 3.2 cd/lm
LEDs/each optic 1
Light colour/type RGBW
Required components:
 C13584_CLAMP-VERO29
 Bender Wirth: 500 Typ L3-1

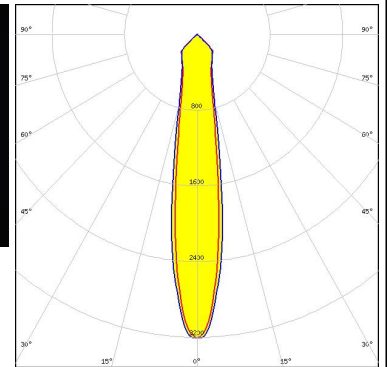

Light distribution files



LED CTM-22 (Tunable White)
FWHM / FWTM 29.0°
Efficiency 91 %
Peak intensity 1.6 cd/lm
LEDs/each optic 1
Light colour/type White
Required components:
 C13584_CLAMP-VERO29
 Bender Wirth: 494 Typ L3

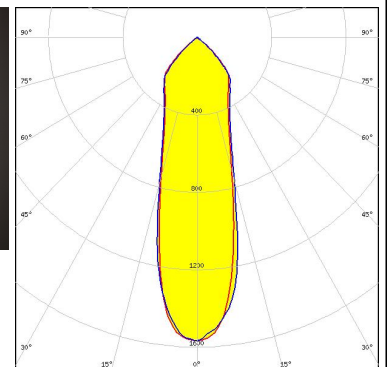
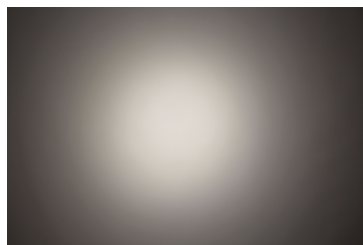

Light distribution files

OPTICAL RESULTS (MEASURED):



LED CTM-22 (Tunable White)
FWHM / FWTM 32.0° / 95.0°
Efficiency 87 %
Peak intensity 1.4 cd/lm
LEDs/each optic 1
Light colour/type White
Required components:
 C13584_CLAMP-VERO29
 F13671_ANGE-RZ-LENS
 Bender Wirth: 494 Typ L3

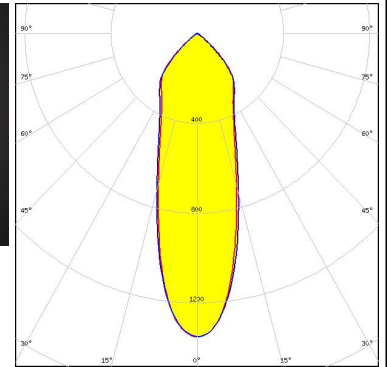
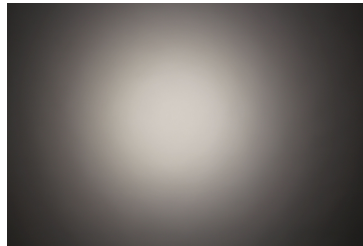

Light distribution files



LED CxM-14 (19x19)
FWHM / FWTM 20.0° / 86.0°
Efficiency 94 %
Peak intensity 2.5 cd/lm
LEDs/each optic 1
Light colour/type White
Required components:
 TE Connectivity: 2213254-2 + OPTIC CLIP Z50 TYPE1 2213194-1

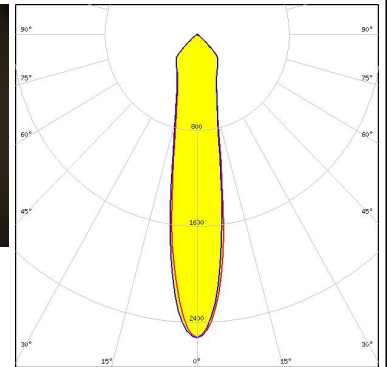
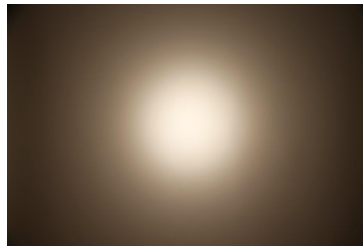

Light distribution files



LED COB J-Type
FWHM / FWTM 20.0° / 85.0°
Efficiency 94 %
Peak intensity 2.5 cd/lm
LEDs/each optic 1
Light colour/type White
Required components:
 IDEAL: 50-2103NC + 50-2100AN

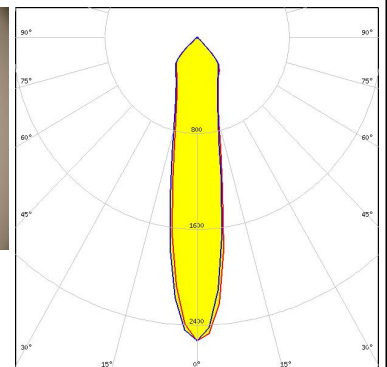
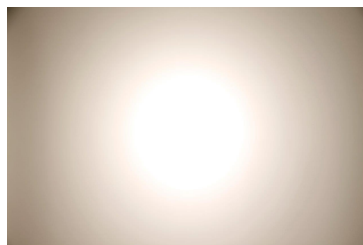

Light distribution files

OPTICAL RESULTS (MEASURED):



LED COB J-Type
FWHM / FWTM 24.0° / 90.0°
Efficiency 87 %
Peak intensity 1.7 cd/lm
LEDs/each optic 1
Light colour/type White
Required components:
 F13671_ANGE-RZ-LENS
 IDEAL: 50-2103NC + 50-2100AN

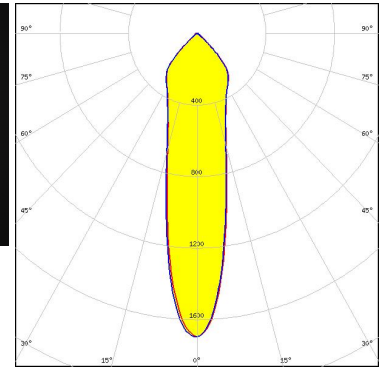
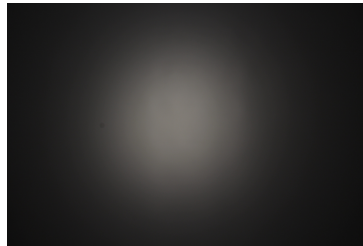

Light distribution files



LED COB J-Type
FWHM / FWTM 22.0° / 89.0°
Efficiency 93 %
Peak intensity 2.3 cd/lm
LEDs/each optic 1
Light colour/type White
Required components:
 C13658_CLAMP-VERO13-18
 Bender Wirth: 463 Typ L2

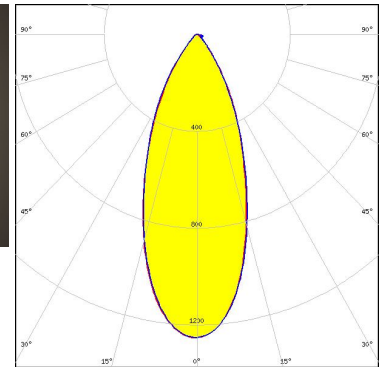
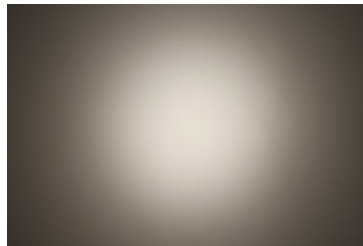

Light distribution files



LED COB L-Type (LES 11)
FWHM / FWTM 18.0° / 78.0°
Efficiency 93 %
Peak intensity 2.8 cd/lm
LEDs/each optic 1
Light colour/type White
Required components:
 C13658_CLAMP-VERO13-18
 Bender Wirth: 438 Typ L1

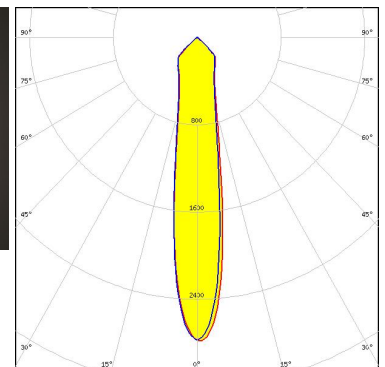
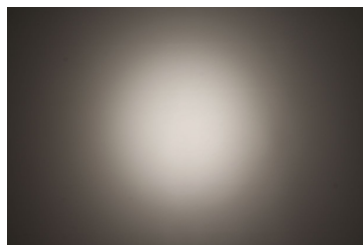

Light distribution files

OPTICAL RESULTS (MEASURED):



LED COB L-Type (LES 11)
 FWHM / FWTM 23.0° / 92.0°
 Efficiency 86 %
 Peak intensity 1.7 cd/lm
 LEDs/each optic 1
 Light colour/type White

Required components:

F13671_ANGE-RZ-LENS

TE Connectivity: 2213382-2 + OPTIC CLIP Z50 TYPE1 2213194-1

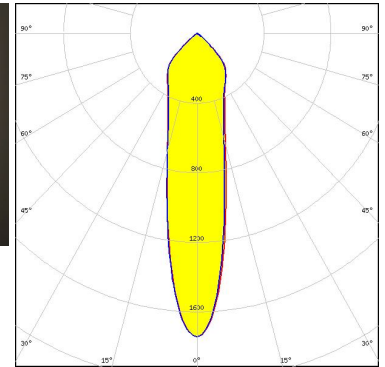

Light distribution files



LED COB L-Type (LES 11)
 FWHM / FWTM 17.0° / 86.0°
 Efficiency 92 %
 Peak intensity 2.7 cd/lm
 LEDs/each optic 1
 Light colour/type White

Required components:

TE Connectivity: 2213382-2 + OPTIC CLIP Z50 TYPE1 2213194-1

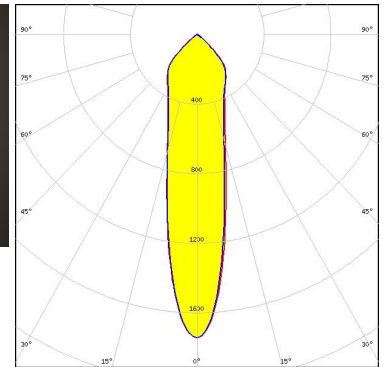

Light distribution files



LED COB L-Type (LES 11)
 FWHM / FWTM 22.0° / 93.0°
 Efficiency 94 %
 Peak intensity 2.2 cd/lm
 LEDs/each optic 1
 Light colour/type White

Required components:

Molex: 180580-0005

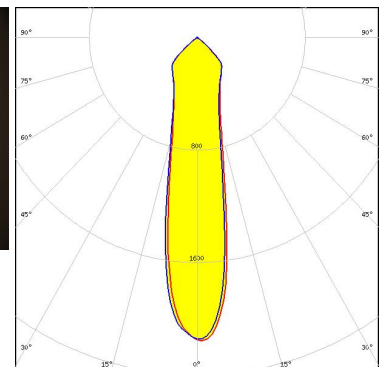
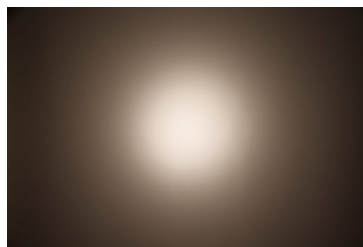

Light distribution files

OPTICAL RESULTS (MEASURED):



LED COB L-Type (LES 11)
 FWHM / FWTM 19.0° / 88.0°
 Efficiency 87 %
 Peak intensity 2.1 cd/lm
 LEDs/each optic 1
 Light colour/type White
 Required components:
 F13671_ANGE-RZ-LENS
 IDEAL: 50-2100NC + 50-2100AN

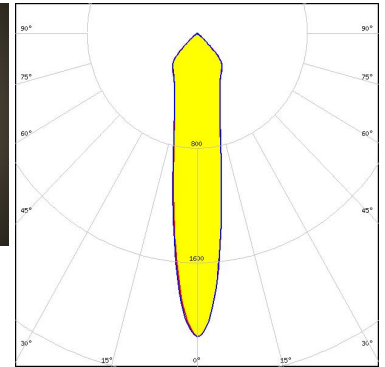
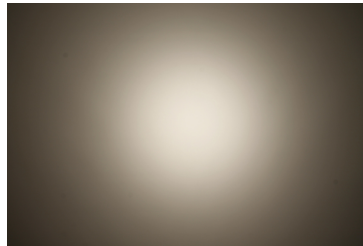

Light distribution files



LED COB L-Type (LES 11)
 FWHM / FWTM 16.0° / 71.0°
 Efficiency 91 %
 Peak intensity 3.1 cd/lm
 LEDs/each optic 1
 Light colour/type White
 Required components:
 IDEAL: 50-2100NC + 50-2100AN

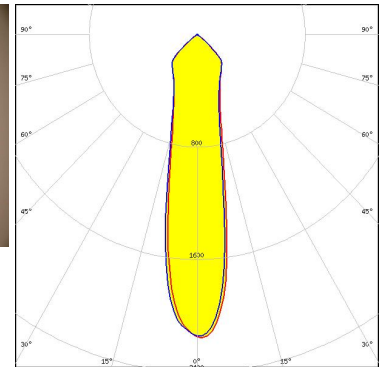
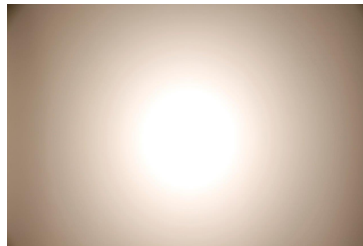

Light distribution files



LED COB L-Type (LES 11)
 FWHM / FWTM 17.0° / 86.0°
 Efficiency 92 %
 Peak intensity 2.7 cd/lm
 LEDs/each optic 1
 Light colour/type White
 Required components:
 TE Connectivity: 2213382-2 + OPTIC CLIP Z50 TYPE1 2213194-1

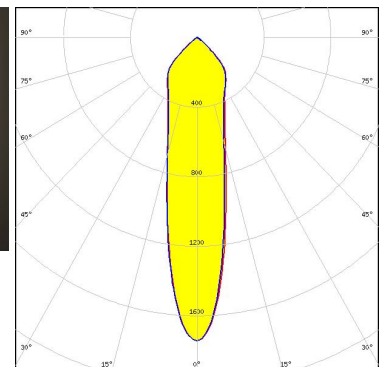
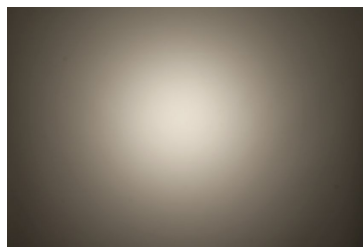

Light distribution files

OPTICAL RESULTS (MEASURED):



LED NVCWJ024Z-V1MT: COB J-Type Tunable White
 FWHM / FWTM 18.0° / 80.0°
 Efficiency 93 %
 Peak intensity 2.8 cd/lm
 LEDs/each optic 1
 Light colour/type White
 Required components:
 C13658_CLAMP-VERO13-18
 Bender Wirth: 498 Typ L2

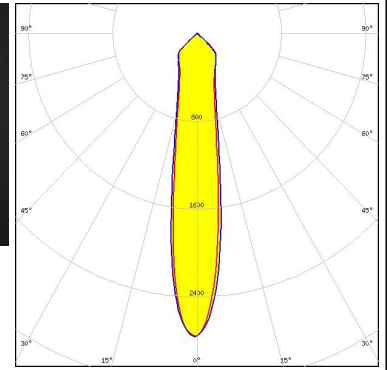

Light distribution files



LED NVCWJ024Z-V1MT: COB J-Type Tunable White
 FWHM / FWTM 22.0° / 91.0°
 Efficiency 88 %
 Peak intensity 2 cd/lm
 LEDs/each optic 1
 Light colour/type White
 Required components:
 C13658_CLAMP-VERO13-18
 F13671_ANGE-RZ-LENS
 Bender Wirth: 498 Typ L2

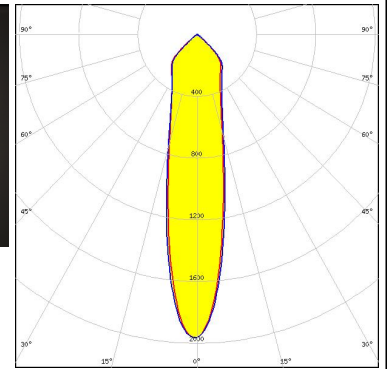

Light distribution files



LED PrevaLED Core AC (LEP-2000)
 FWHM / FWTM 23.0° / 88.0°
 Efficiency 93 %
 Peak intensity 2.1 cd/lm
 LEDs/each optic 1
 Light colour/type White
 Required components:
 TE Connectivity: OPTIC CLIP Z50 TYPE1 2213194-1

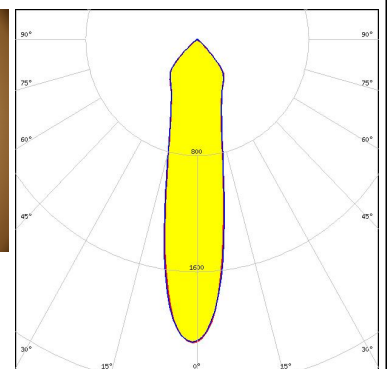
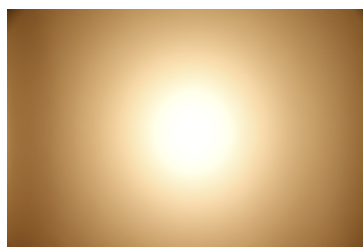

Light distribution files

OPTICAL RESULTS (MEASURED):

OSRAM

LED PrevaLED Core AC (LEP-800)
 FWHM / FWTM 16.0° / 76.0°
 Efficiency 94 %
 Peak intensity 3.1 cd/lm
 LEDs/each optic 1
 Light colour/type White
 Required components:
 TE Connectivity: OPTIC CLIP Z50 TYPE1 2213194-1

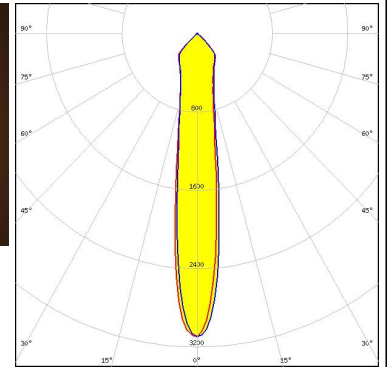
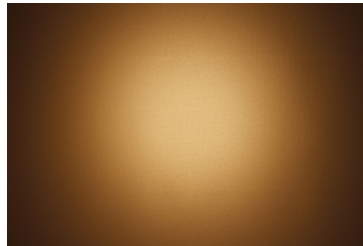

Light distribution files

OSRAM

LED PrevaLED Core G7 L15 H1
 FWHM / FWTM 24.0° / 90.0°
 Efficiency 91 %
 Peak intensity 1.9 cd/lm
 LEDs/each optic 1
 Light colour/type White
 Required components:
 C16685_CLAMP-PRV-A
 F13671_ANGE-RZ-LENS

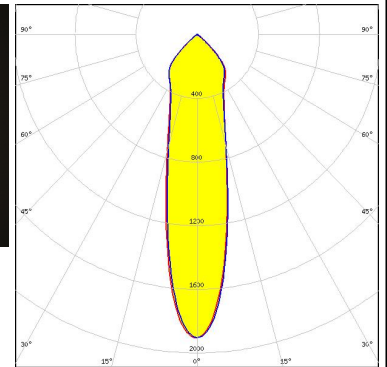
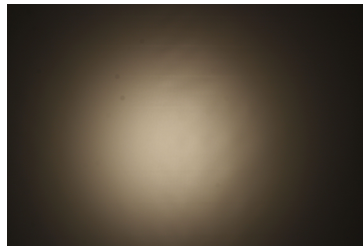

Light distribution files

OSRAM

LED PrevaLED Core G7 L15 H1
 FWHM / FWTM 21.0° / 88.0°
 Efficiency 94 %
 Peak intensity 2.4 cd/lm
 LEDs/each optic 1
 Light colour/type White
 Required components:
 C16685_CLAMP-PRV-A

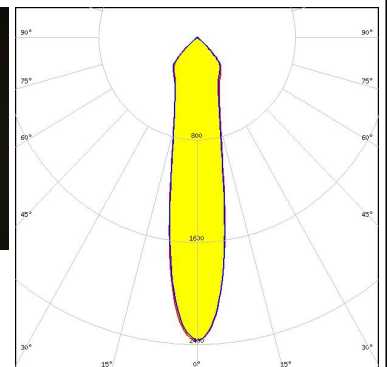
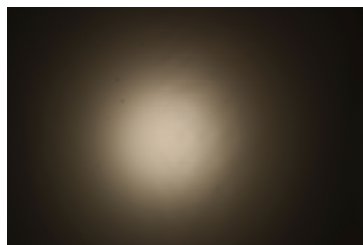

Light distribution files

OPTICAL RESULTS (MEASURED):

OSRAM

LED PrevaLED Core Z3 LES19
 FWHM / FWTM 23.0° / 89.0°
 Efficiency 94 %
 Peak intensity 2.2 cd/lm
 LEDs/each optic 1
 Light colour/type White
 Required components:
 TE Connectivity: OPTIC CLIP Z50 TYPE1 2213194-1

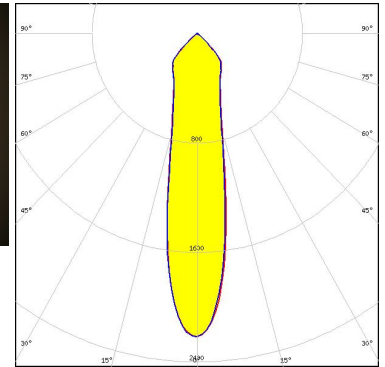

Light distribution files

OSRAM

LED PrevaLED Core Z3 LES23
 FWHM / FWTM 27.0° / 91.0°
 Efficiency 94 %
 Peak intensity 1.8 cd/lm
 LEDs/each optic 1
 Light colour/type White
 Required components:
 TE Connectivity: OPTIC CLIP Z50 TYPE1 2213194-1

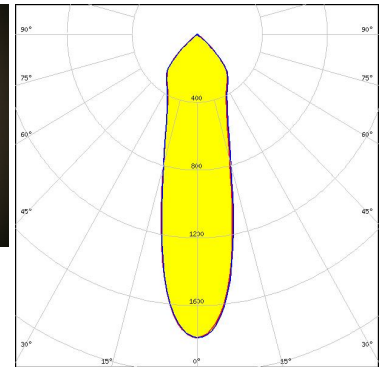
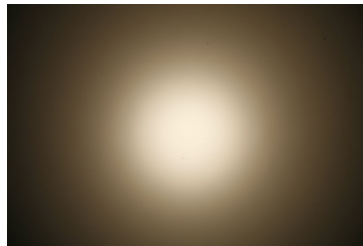

Light distribution files

OSRAM

LED PrevaLED Core Z3 LES9
 FWHM / FWTM 14.0° / 54.0°
 Efficiency 94 %
 Peak intensity 3.8 cd/lm
 LEDs/each optic 1
 Light colour/type White
 Required components:
 TE Connectivity: OPTIC CLIP Z50 TYPE1 2213194-1

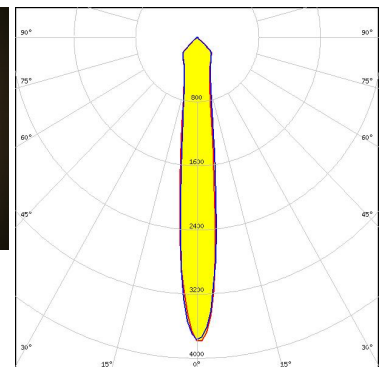
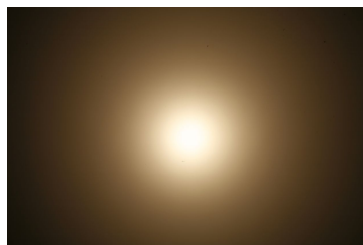

Light distribution files

OPTICAL RESULTS (MEASURED):

OSRAM

LED PrevaLED Core Z4 LES19
 FWHM / FWTM 21.0° / 87.0°
 Efficiency 94 %
 Peak intensity 2.3 cd/lm
 LEDs/each optic 1
 Light colour/type White
 Required components:
 TE Connectivity: OPTIC CLIP Z50 TYPE1 2213194-1

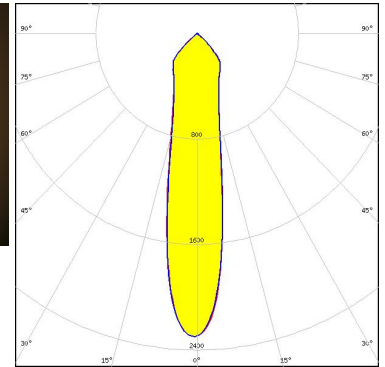
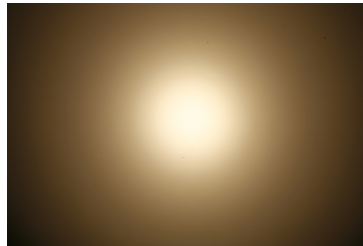

Light distribution files

OSRAM

LED PrevaLED Core Z4 LES19
 FWHM / FWTM 26.0° / 92.0°
 Efficiency 88 %
 Peak intensity 1.6 cd/lm
 LEDs/each optic 1
 Light colour/type White
 Required components:
 F13671_ANGE-RZ-LENS
 TE Connectivity: OPTIC CLIP Z50 TYPE1 2213194-1

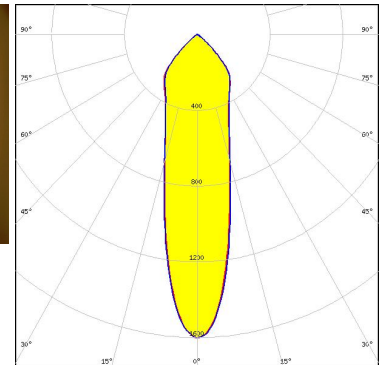
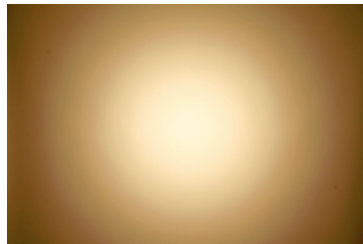

Light distribution files

OSRAM Opto Semiconductors

LED Soleriq S13
 FWHM / FWTM 20.0° / 82.0°
 Efficiency 94 %
 Peak intensity 2.8 cd/lm
 LEDs/each optic 1
 Light colour/type White
 Required components:
 TE Connectivity: 2213401-2 + OPTIC CLIP Z50 TYPE1 2213194-1

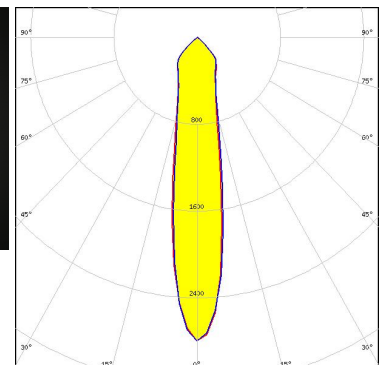

Light distribution files

OPTICAL RESULTS (MEASURED):

OSRAM
Opto Semiconductors

LED Soleriq S13
FWHM / FWTM 20.0° / 89.0°
Efficiency 92 %
Peak intensity 2.4 cd/lm
LEDs/each optic 1
Light colour/type White
Required components:
C13658_CLAMP-VERO13-18
Bender Wirth: 437 Typ L1

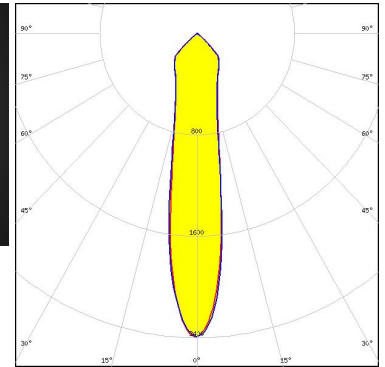
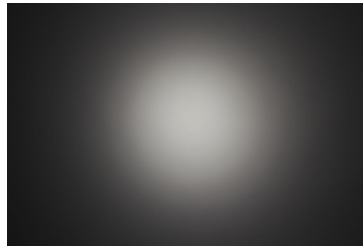

Light distribution files

OSRAM
Opto Semiconductors

LED Soleriq S13 19x19
FWHM / FWTM 22.0° / 90.0°
Efficiency 87 %
Peak intensity 1.9 cd/lm
LEDs/each optic 1
Light colour/type White
Required components:
F13671_ANGE-RZ-LENS
IDEAL: 50-2103CT + 50-2100AN

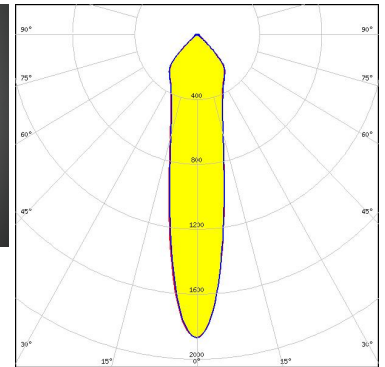

Light distribution files

OSRAM
Opto Semiconductors

LED Soleriq S13 19x19
FWHM / FWTM 19.0° / 84.0°
Efficiency 93 %
Peak intensity 2.7 cd/lm
LEDs/each optic 1
Light colour/type White
Required components:
TE Connectivity: 2213254-2 + OPTIC CLIP Z50 TYPE1 2213194-1

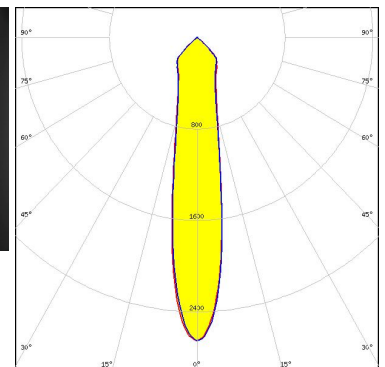
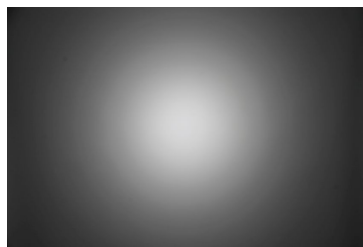

Light distribution files

OPTICAL RESULTS (MEASURED):

OSRAM
Opto Semiconductors

LED Soleriq S13 19x19
 FWHM / FWTM 17.0° / 86.0°
 Efficiency 91 %
 Peak intensity 2.6 cd/lm
 LEDs/each optic 1
 Light colour/type White
 Required components:
 IDEAL: 50-2103CT + 50-2100AN

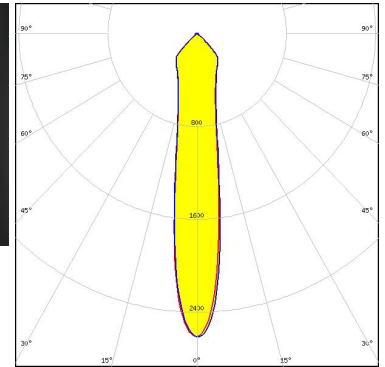
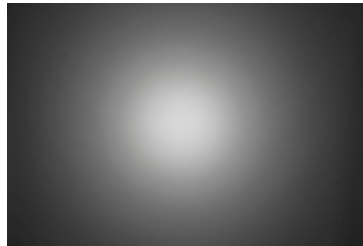

Light distribution files

OSRAM
Opto Semiconductors

LED Soleriq S13 19x19
 FWHM / FWTM 22.0° / 90.0°
 Efficiency 88 %
 Peak intensity 2.1 cd/lm
 LEDs/each optic 1
 Light colour/type White
 Required components:
 F13671_ANGE-RZ-LENS
 TE Connectivity: 2213254-2 + OPTIC CLIP Z50 TYPE1 2213194-1

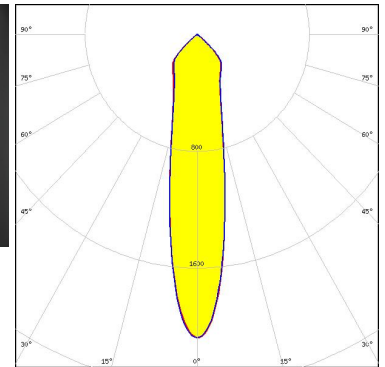
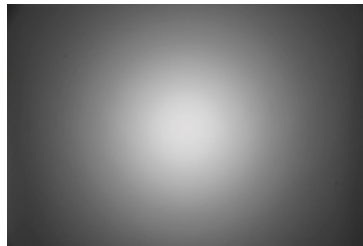

Light distribution files

OSRAM
Opto Semiconductors

LED Soleriq S19
 FWHM / FWTM 27.0° / 93.0°
 Efficiency 88 %
 Peak intensity 1.6 cd/lm
 LEDs/each optic 1
 Light colour/type White
 Required components:
 F13671_ANGE-RZ-LENS
 TE Connectivity: 2213407-2 + OPTIC CLIP Z50 TYPE1 2213194-1

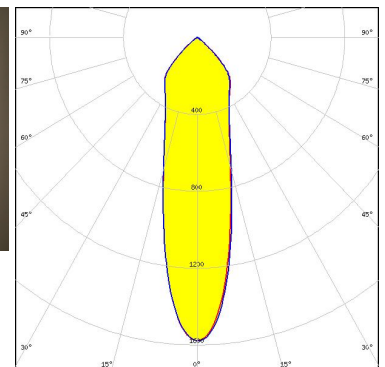
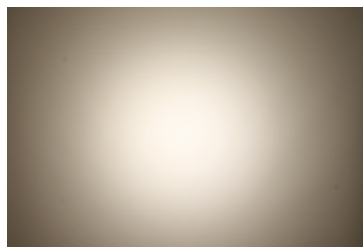

Light distribution files

OPTICAL RESULTS (MEASURED):

OSRAM
Opto Semiconductors

LED Soleriq S19
FWHM / FWTM 22.0° / 87.0°
Efficiency 94 %
Peak intensity 2.4 cd/lm
LEDs/each optic 1
Light colour/type White

Required components:

TE Connectivity: 2213407-2 + OPTIC CLIP Z50 TYPE1 2213194-1

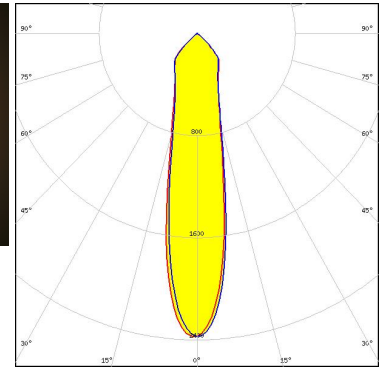

Light distribution files

OSRAM
Opto Semiconductors

LED Soleriq S19
FWHM / FWTM 23.0° / 89.0°
Efficiency 92 %
Peak intensity 2.1 cd/lm
LEDs/each optic 1
Light colour/type White

Required components:

C13584_CLAMP-VERO29

Bender Wirth: 462 Typ L3

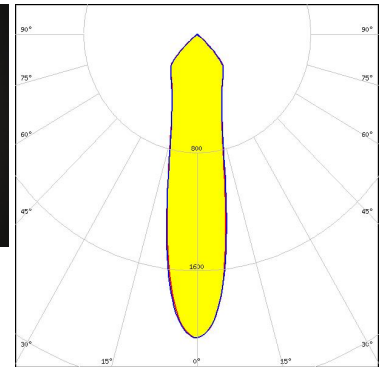
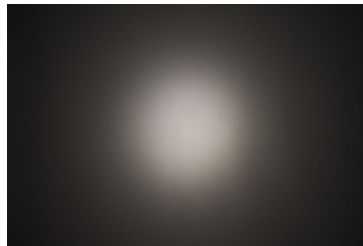

Light distribution files

PHILIPS

LED Fortimo SLM L09 + SLM holder
FWHM / FWTM 15.0° / 70.0°
Efficiency 92 %
Peak intensity 3.2 cd/lm
LEDs/each optic 1
Light colour/type White

Required components:

TE Connectivity: OPTIC CLIP Z50 TYPE1 2213194-1

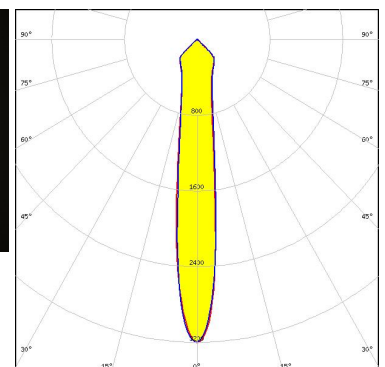

Light distribution files

OPTICAL RESULTS (MEASURED):

PHILIPS

LED Fortimo SLM L13 + SLM holder
FWHM / FWTM 19.0° / 86.0°
Efficiency 92 %
Peak intensity 2.6 cd/lm
LEDs/each optic 1
Light colour/type White
Required components:
TE Connectivity: OPTIC CLIP Z50 TYPE1 2213194-1

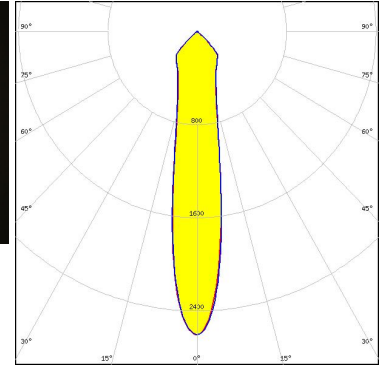

Light distribution files

PHILIPS

LED Fortimo SLM L13 CoB
FWHM / FWTM 23.0° / 89.0°
Efficiency 88 %
Peak intensity 2 cd/lm
LEDs/each optic 1
Light colour/type White
Required components:
F13671_ANGE-RZ-LENS
TE Connectivity: 2213130-2 + OPTIC CLIP Z50 TYPE1 2213194-1



PHILIPS

LED Fortimo SLM L13 CoB
FWHM / FWTM 20.0° / 78.0°
Efficiency 94 %
Peak intensity 2.8 cd/lm
LEDs/each optic 1
Light colour/type White
Required components:
TE Connectivity: 2213130-2 + OPTIC CLIP Z50 TYPE1 2213194-1

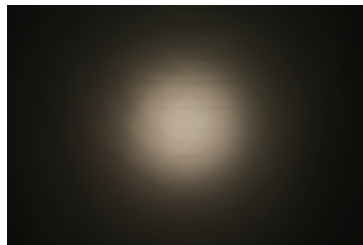

OPTICAL RESULTS (MEASURED):

PHILIPS

LED Fortimo SLM L15 + SLM holder
 FWHM / FWTM 21.0° / 88.0°
 Efficiency 91 %
 Peak intensity 2.2 cd/lm
 LEDs/each optic 1
 Light colour/type White
 Required components:
 TE Connectivity: OPTIC CLIP Z50 TYPE1 2213194-1

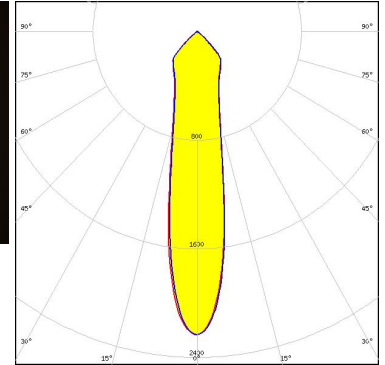
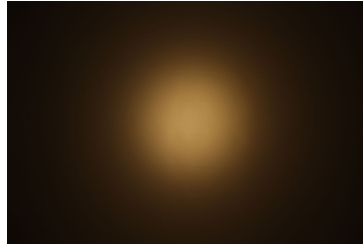

Light distribution files

PHILIPS

LED Fortimo SLM L15 + SLM holder
 FWHM / FWTM 27.0° / 93.0°
 Efficiency 87 %
 Peak intensity 1.6 cd/lm
 LEDs/each optic 1
 Light colour/type White
 Required components:
 F13671_ANGE-RZ-LENS
 TE Connectivity: OPTIC CLIP Z50 TYPE1 2213194-1

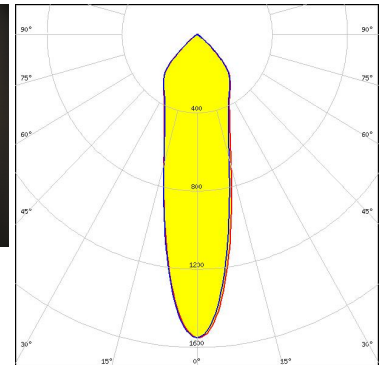
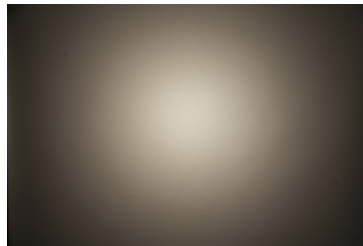

Light distribution files

PHILIPS

LED Fortimo SLM L15 CoB
 FWHM / FWTM 24.0° / 90.0°
 Efficiency 88 %
 Peak intensity 2 cd/lm
 LEDs/each optic 1
 Light colour/type White
 Required components:
 F13671_ANGE-RZ-LENS
 TE Connectivity: 2213130-2 + OPTIC CLIP Z50 TYPE1 2213194-1

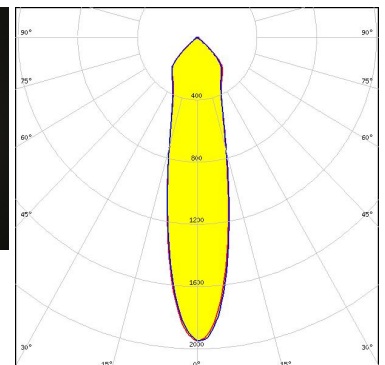
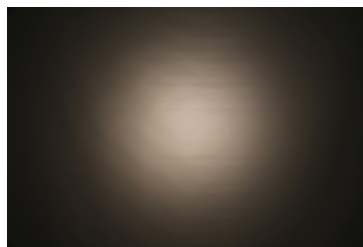

Light distribution files

OPTICAL RESULTS (MEASURED):

PHILIPS

LED Fortimo SLM L15 CoB
FWHM / FWTM 22.0° / 86.0°
Efficiency 94 %
Peak intensity 2.5 cd/lm
LEDs/each optic 1
Light colour/type White
Required components:
TE Connectivity: 2213130-2 + OPTIC CLIP Z50 TYPE1 2213194-1

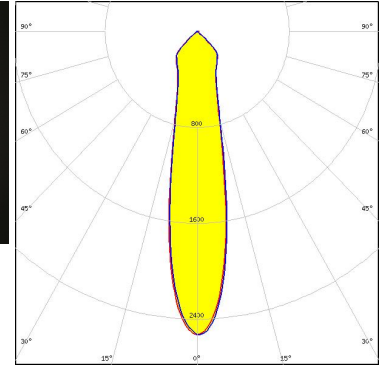

Light distribution files

PHILIPS

LED Fortimo SLM L19 + SLM holder
FWHM / FWTM 26.0° / 91.0°
Efficiency 90 %
Peak intensity 1.8 cd/lm
LEDs/each optic 1
Light colour/type White
Required components:
TE Connectivity: OPTIC CLIP Z50 TYPE1 2213194-1

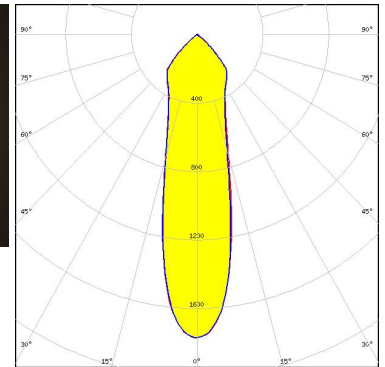
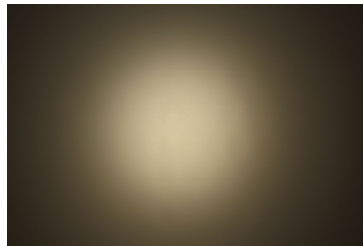

Light distribution files

SAMSUNG

LED LC026B / 033B / 040B
FWHM / FWTM 24.0° / 89.0°
Efficiency 93 %
Peak intensity 2.1 cd/lm
LEDs/each optic 1
Light colour/type White
Required components:
TE Connectivity: 2213258-2 + OPTIC CLIP Z50 TYPE1 2213194-1

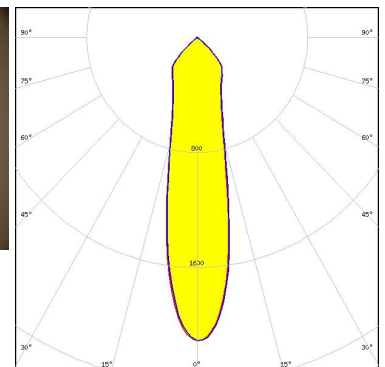
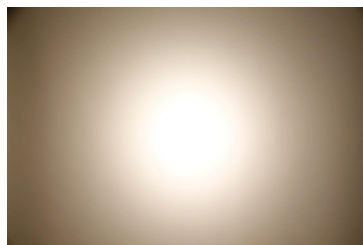

Light distribution files

OPTICAL RESULTS (MEASURED):

SAMSUNG

LED LC026B / 033B / 040B
 FWHM / FWTM 25.0° / 92.0°
 Efficiency 92 %
 Peak intensity 1.8 cd/lm
 LEDs/each optic 1
 Light colour/type White
 Required components:
 C13658_CLAMP-VERO13-18
 Bender Wirth: 450 Typ L2

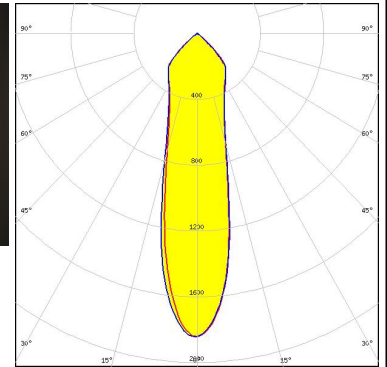

Light distribution files

SAMSUNG

LED LC035T (Tunable white)
 FWHM / FWTM 34.0° / 95.0°
 Efficiency 89 %
 Peak intensity 1.3 cd/lm
 LEDs/each optic 1
 Light colour/type Tunable White
 Required components:
 C13584_CLAMP-VERO29
 F13671_ANGE-RZ-LENS
 Bender Wirth: 502 Typ L3

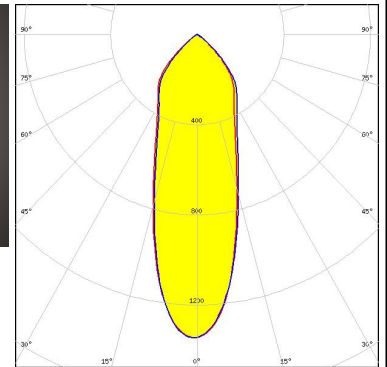
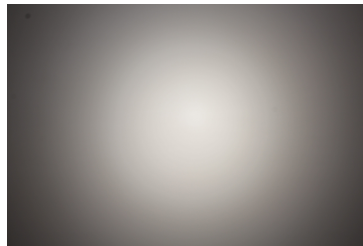

Light distribution files

SAMSUNG

LED LC035T (Tunable white)
 FWHM / FWTM 31.0° / 93.0°
 Efficiency 94 %
 Peak intensity 1.6 cd/lm
 LEDs/each optic 1
 Light colour/type Tunable White
 Required components:
 C13584_CLAMP-VERO29
 Bender Wirth: 502 Typ L3

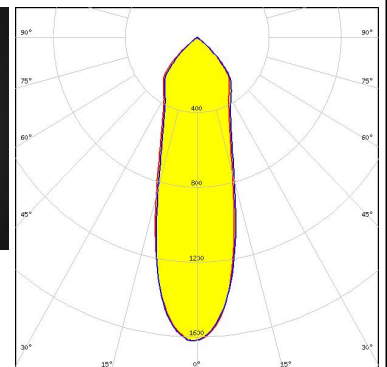
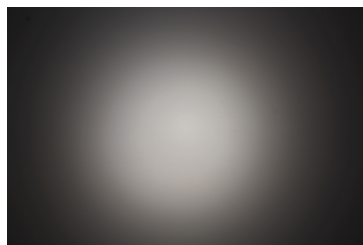

Light distribution files

OPTICAL RESULTS (MEASURED):

SAMSUNG

LED LC040C
 FWHM / FWTM 18.0° / 87.0°
 Efficiency 92 %
 Peak intensity 2.6 cd/lm
 LEDs/each optic 1
 Light colour/type White

Required components:

TE Connectivity: 2213382-2 + OPTIC CLIP Z50 TYPE1 2213194-1

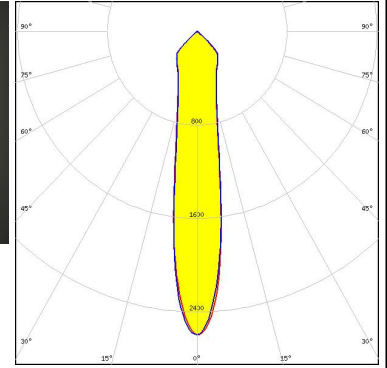

Light distribution files

SAMSUNG

LED LC040C
 FWHM / FWTM 21.0° / 89.0°
 Efficiency 89 %
 Peak intensity 2.2 cd/lm
 LEDs/each optic 1
 Light colour/type White

Required components:

F13671_ANGE-RZ-LENS
 TE Connectivity: 2213382-2 + OPTIC CLIP Z50 TYPE1 2213194-1

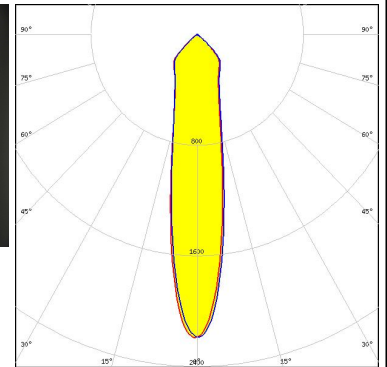
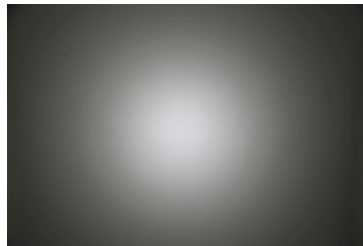

Light distribution files



LED AC Zhaga COB
 FWHM / FWTM 30.0° / 96.0°
 Efficiency 88 %
 Peak intensity 1.4 cd/lm
 LEDs/each optic 1
 Light colour/type White

Required components:

F13671_ANGE-RZ-LENS
 Optosource: SEHSMJD-A

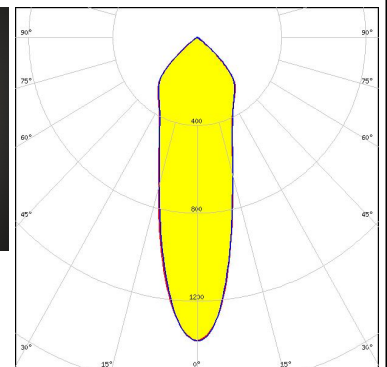
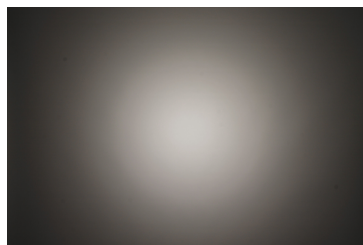

Light distribution files

OPTICAL RESULTS (MEASURED):

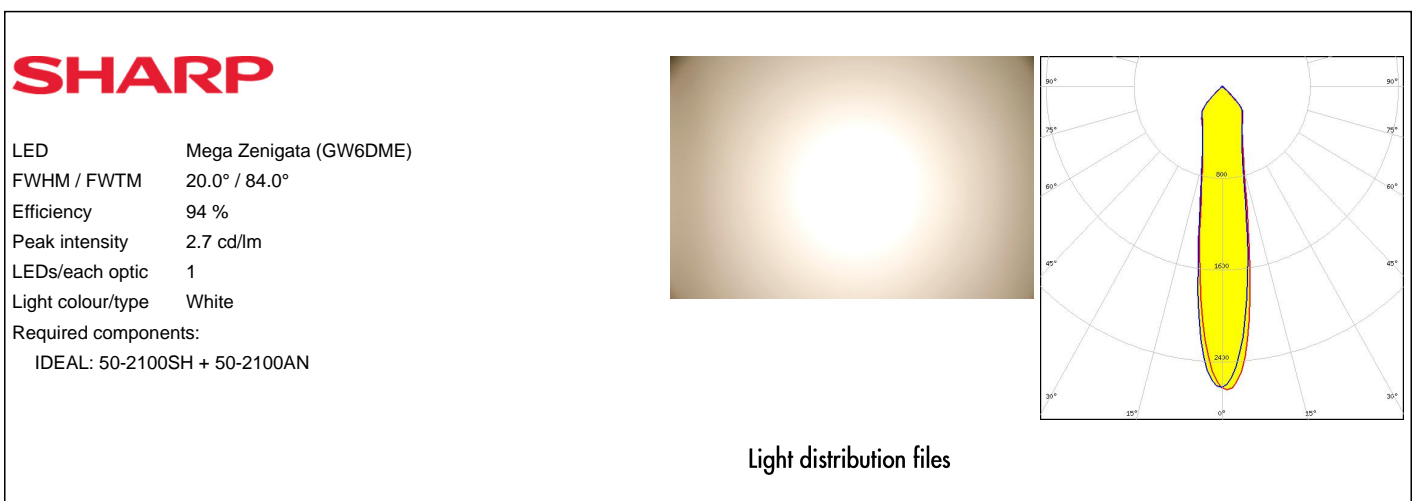
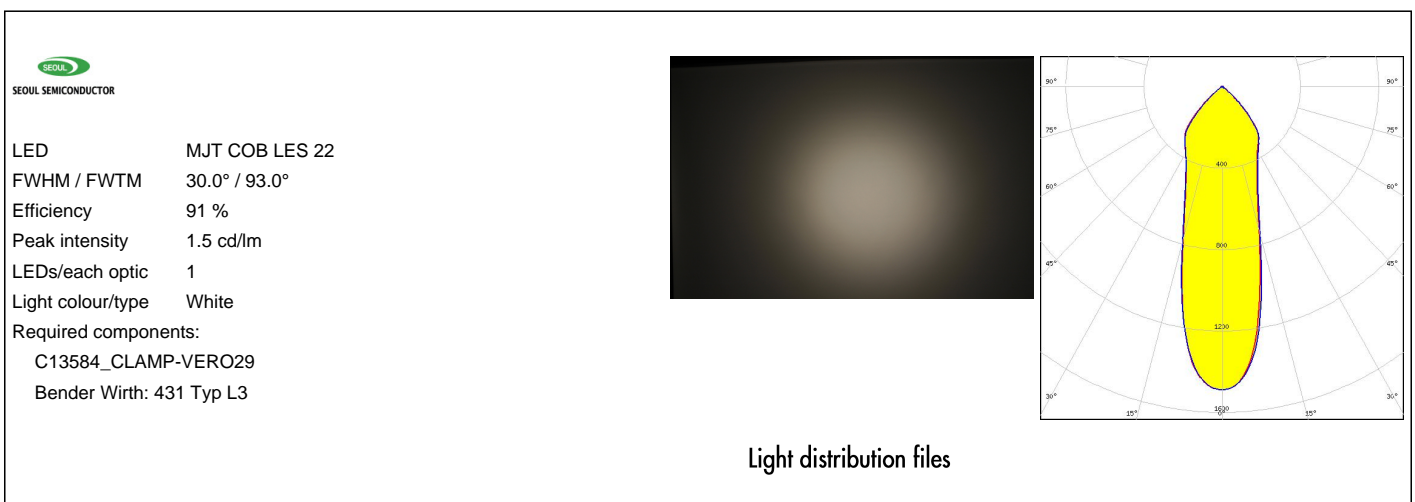
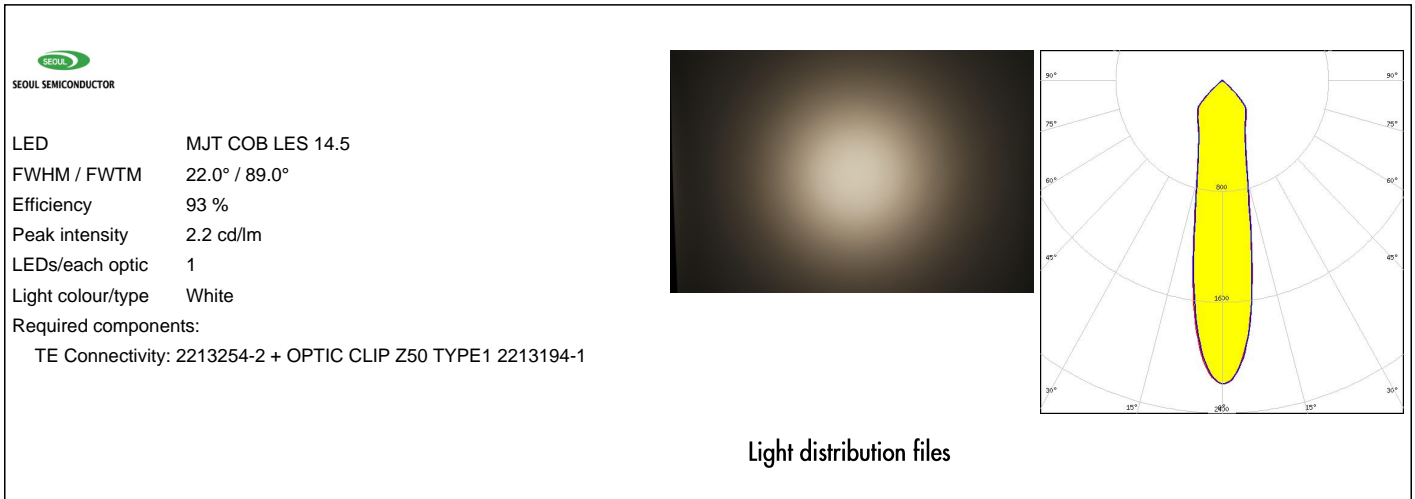

OPTICAL RESULTS (MEASURED):

SHARP

LED Mega Zenigata (GW6DME)
 FWHM / FWTM 24.0° / 91.0°
 Efficiency 89 %
 Peak intensity 1.9 cd/lm
 LEDs/each optic 1
 Light colour/type White
 Required components:
 F13671_ANGE-RZ-LENS
 TE Connectivity: 2213130-2 + OPTIC CLIP Z50 TYPE1 2213194-1

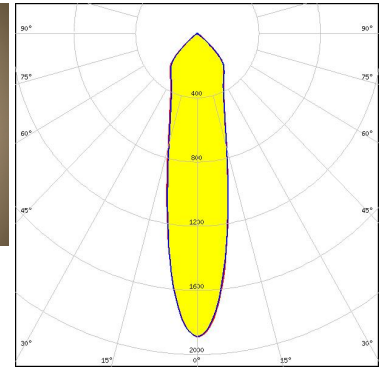
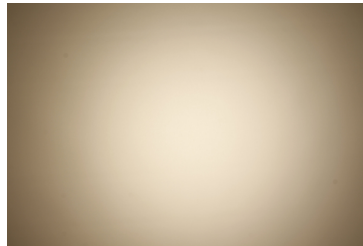

Light distribution files

SHARP

LED Mega Zenigata (GW6DME)
 FWHM / FWTM 21.0° / 75.0°
 Efficiency 92 %
 Peak intensity 2.8 cd/lm
 LEDs/each optic 1
 Light colour/type White
 Required components:
 TE Connectivity: 2213130-2 + OPTIC CLIP Z50 TYPE1 2213194-1

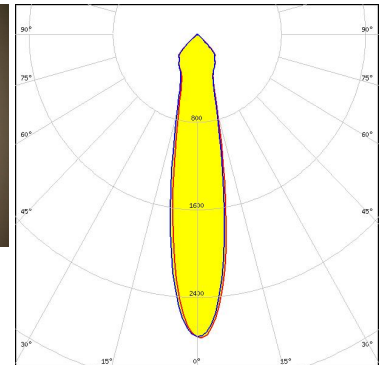
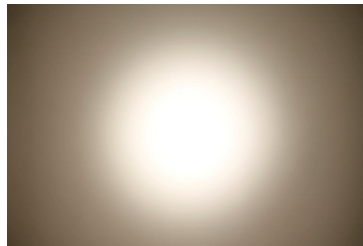

Light distribution files

VS LIGHTING SOLUTIONS

LED WU-M-461
 FWHM / FWTM 20.0° / 78.0°
 Efficiency 94 %
 Peak intensity 2.7 cd/lm
 LEDs/each optic 1
 Light colour/type White
 Required components:
 TE Connectivity: OPTIC CLIP Z50 TYPE1 2213194-1

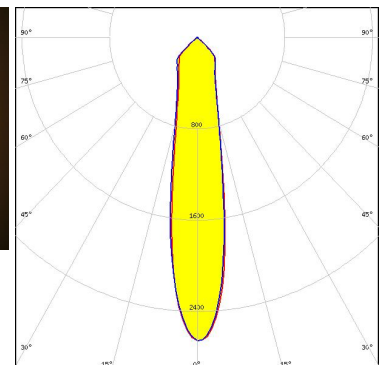
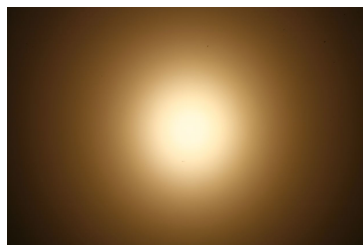

Light distribution files

OPTICAL RESULTS (MEASURED):



LED WU-M-462
 FWHM / FWTM 26.0° / 89.0°
 Efficiency 94 %
 Peak intensity 2 cd/lm
 LEDs/each optic 1
 Light colour/type White

Required components:

TE Connectivity: OPTIC CLIP Z50 TYPE1 2213194-1

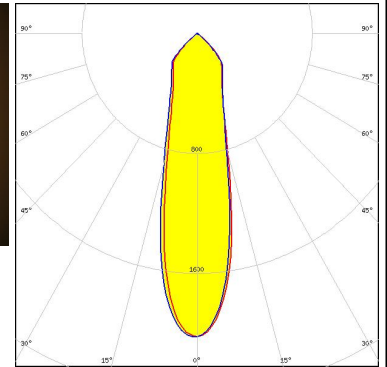

Light distribution files



LED WU-M-464
 FWHM / FWTM 26.0° / 89.0°
 Efficiency 94 %
 Peak intensity 2 cd/lm
 LEDs/each optic 1
 Light colour/type White

Required components:

TE Connectivity: OPTIC CLIP Z50 TYPE1 2213194-1

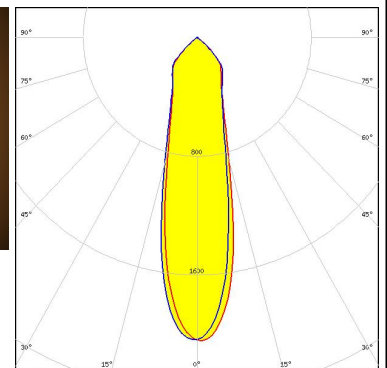
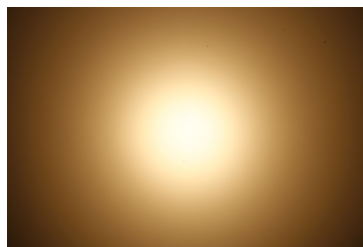

Light distribution files



LED WU-M-484
 FWHM / FWTM 21.0° / 88.0°
 Efficiency 93 %
 Peak intensity 2.4 cd/lm
 LEDs/each optic 1
 Light colour/type White

Required components:

TE Connectivity: OPTIC CLIP Z50 TYPE1 2213194-1

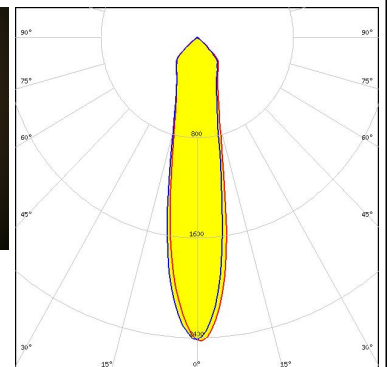
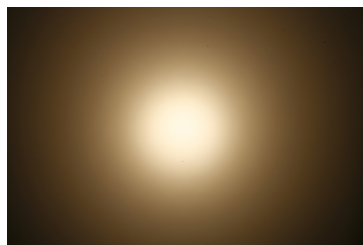

Light distribution files

OPTICAL RESULTS (MEASURED):



LED WU-M-484
FWHM / FWTM 25.0° / 91.0°
Efficiency 88 %
Peak intensity 1.8 cd/lm
LEDs/each optic 1
Light colour/type White
Required components:
 C13333_MIRELLA-CL
 TE Connectivity: OPTIC CLIP Z50 TYPE1 2213194-1

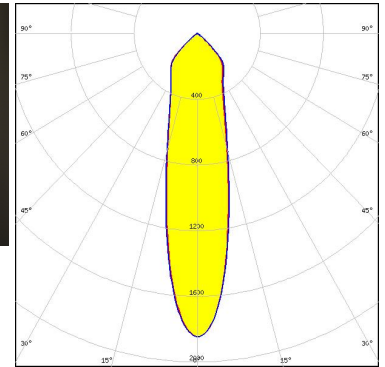
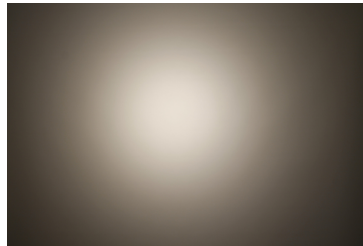

Light distribution files



LED WU-M-485
FWHM / FWTM 27.0° / 81.0°
Efficiency 93 %
Peak intensity 1.9 cd/lm
LEDs/each optic 1
Light colour/type White
Required components:
 TE Connectivity: OPTIC CLIP Z50 TYPE1 2213194-1

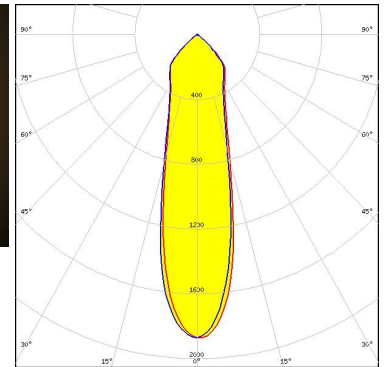

Light distribution files



LED WU-M-486
FWHM / FWTM 26.0° / 91.0°
Efficiency 93 %
Peak intensity 1.9 cd/lm
LEDs/each optic 1
Light colour/type White
Required components:
 TE Connectivity: OPTIC CLIP Z50 TYPE1 2213194-1

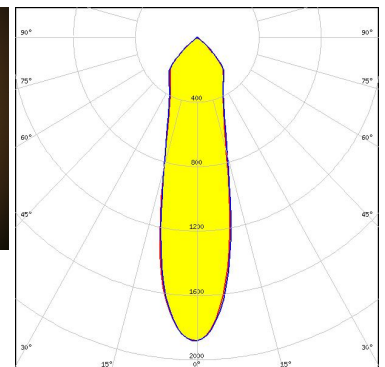
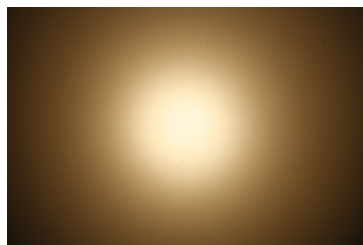

Light distribution files

OPTICAL RESULTS (SIMULATED):



LED V10 Gen7
FWHM / FWTM 17.0° / 32.0°
Efficiency 94 %
Peak intensity 4.3 cd/lm
LEDs/each optic 1
Light colour/type White
Required components:
C13658_CLAMP-VERO13-18

Bender Wirth: 486 Typ L1

Light distribution files

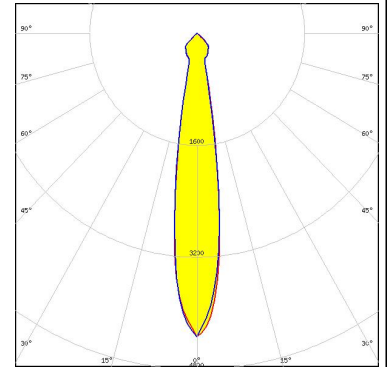

LED V10 Gen7
FWHM / FWTM 17.0° / 33.0°
Efficiency 94 %
Peak intensity 4.2 cd/lm
LEDs/each optic 1
Light colour/type White
Required components:
C13584_CLAMP-VERO29

Bender Wirth: 486 Typ L1

Light distribution files

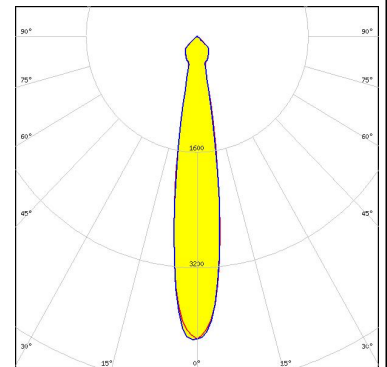

LED V13 Gen7
FWHM / FWTM 16.0° / 34.0°
Efficiency 93 %
Peak intensity 4.6 cd/lm
LEDs/each optic 1
Light colour/type White
Required components:

IDEAL: 50-2103CT + 50-2100AN

Light distribution files

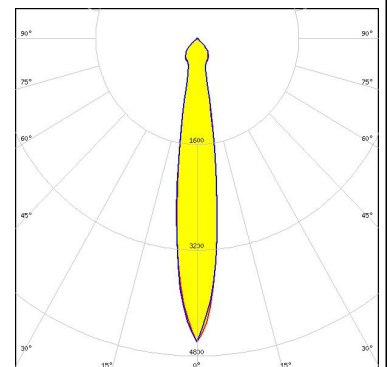

OPTICAL RESULTS (SIMULATED):

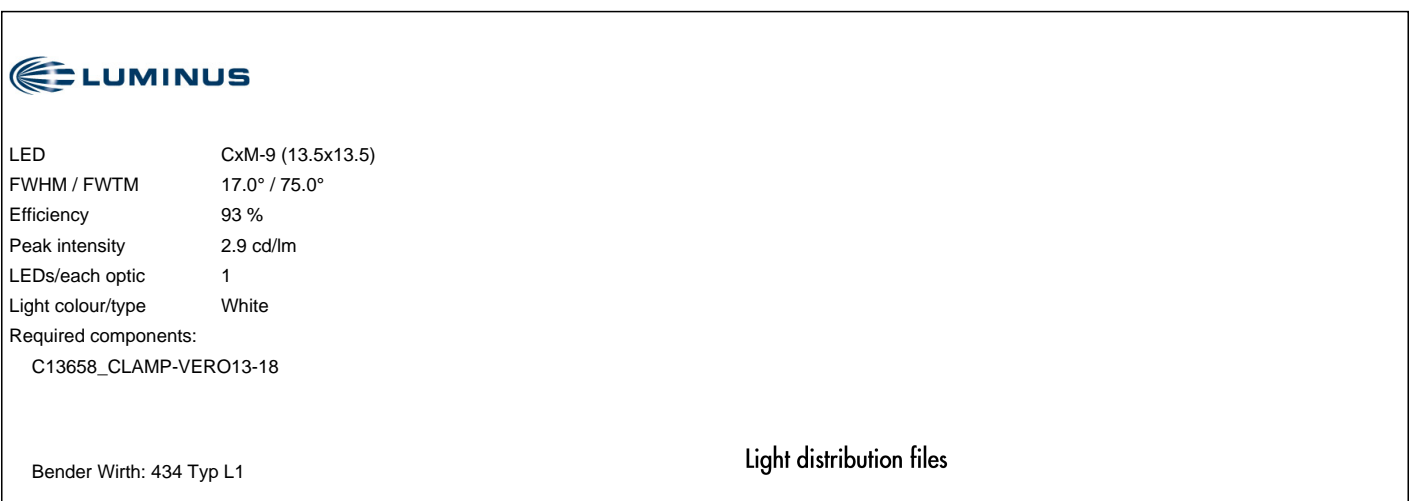
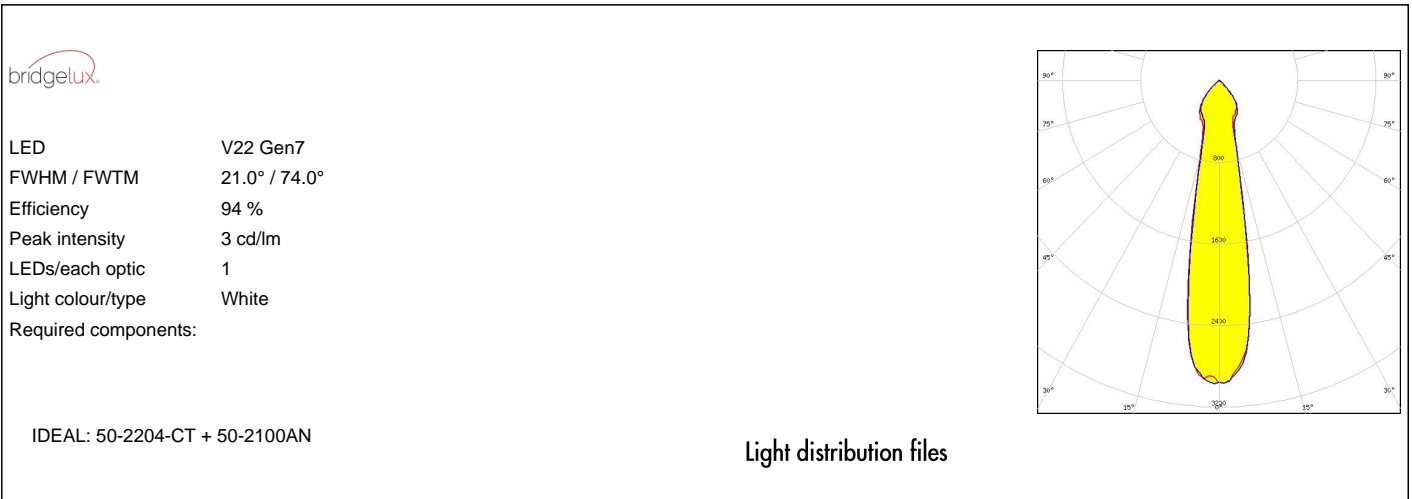

OPTICAL RESULTS (SIMULATED):

 SEUL SEMICONDUCTOR	
LED	ZC12/18
FWHM / FWTM	21.0° / 89.0°
Efficiency	92 %
Peak intensity	2.3 cd/lm
LEDs/each optic	1
Light colour/type	White
Required components: C13658_CLAMP-VERO13-18	
Bender Wirth: 433 Typ L1	

 SEUL SEMICONDUCTOR	
LED	ZC4/6
FWHM / FWTM	17.0° / 75.0°
Efficiency	93 %
Peak intensity	2.9 cd/lm
LEDs/each optic	1
Light colour/type	White
Required components: C13658_CLAMP-VERO13-18	
Bender Wirth: 434 Typ L1	

GENERAL INFORMATION:

NOTE: The typical beam angle will be changed by different color, chip size and chip position tolerance. The typical total beam angle is the full angle measured where the luminous intensity is half of the peak value.

Due to use of high power COB's with this product, special attention to proper thermal design is highly recommended. LEDiL has no liability for direct, indirect or consecutive damages arising from the LEDiL products being used outside of the recommended temperature range.

MATERIALS:

As part of our continuous research and improvement processes, and to ensure the best possible quality and availability of our products, LEDiL reserves the right to change material grades without notice.

PRODUCT DATA USER AGREEMENT AND DISCLAIMER:

The measured data in the provided downloadable LEDiL Product Datasheets and Mechanical 2D-Drawings is rounded and provided as reference for planning. LEDiL Oy's optical specifications have been verified by conducting performance testing of the products in accordance with the company's quality system. The reported data are averaged results of multiple measurements with typical variation. LEDiL Oy reserves the right to without prior notification make changes and improvements to its products.

LEDiL Oy assumes neither warranty, nor guarantee nor any other liability of any kind for the contents and correctness of the provided data. The provided data has been generated with highest diligence but the provided data may in reality not represent the complete possible variation range of all intrinsic parameters. Therefore, in certain cases a deviation from the provided data could occur.

LEDiL Oy reserves the right to undertake technical changes of its products without further notification which could lead to changes in the provided data. LEDiL Oy assumes no liability of any kind for the possible deviation from any provided data or any other damage resulting from the usage of the provided data.

The user agrees to this disclaimer and user agreement with the download or usage of the provided files.

LEDiL Oy

Joensuunkatu 13
FI-24240 SALO
Finland

LEDiL Inc.

228 West Page Street
Suite D
Sycamore IL 60178
USA

Ledil Optics Technology (Shenzhen) Co., Ltd.

405 , Block B
Casic Motor Building
Shenzhen 518057
P.R.CHINA

Local sales and technical support

[www.ledil.com/
where_to_buy](http://www.ledil.com/where_to_buy)

Shipping locations

Poznan, Poland
Hong Kong, China

Distribution Partners

[www.ledil.com/
where_to_buy](http://www.ledil.com/where_to_buy)