

HF
Halogen Free

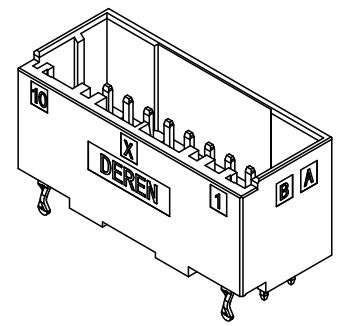

REV.	ECN NO.	LOCATION	DESCRIPTION	DATE	DESIGN
X1			INITIAL RELEASE	2022.09.08	tanghaibo
X2		⊗	新增规格	2022.11.08	tanghaibo
X3		⊗	修改编码电镀选项	2023.02.17	tanghaibo
X4		⊗	更新图面	2023.05.21	tanghaibo

- MATERIAL: HOUSING: GLASS FILED THERMO PLASTIC POLYESTER(94V-0)
COLOR: BLACK OR WHITE
CONTACT: COPPER ALLOY
RETENTION PEG: PRE-TIN COPPER ALLOY
- FINISH(ALL OVER): NICKEL PLATING 1.27um MIN
- FINISH(CONTACT AREA): GOLD PLATING TIN SPECIFICATIONS
REFER TO THE FOLLOWING MATERIAL NUMBER CODE SPECIFICATIONS
- FINISH(CONTACT TAIL): TIN PLATING 2um MIN AFTER
- THE SHAPE, SIZE AND POSITION OF THE CHARACTER
SHOW THE OUTLINE.
THEY DON'T SHOW DETAILS
- DATECODE: YYWWD
YY: YEAR(22:2022)
WW: WEEK(25: THE 25TH WEEK)
D: DAY(1~7: SUNDAY~SATURDAY)
- PART NO.: 56**BG-***H * * * * V000

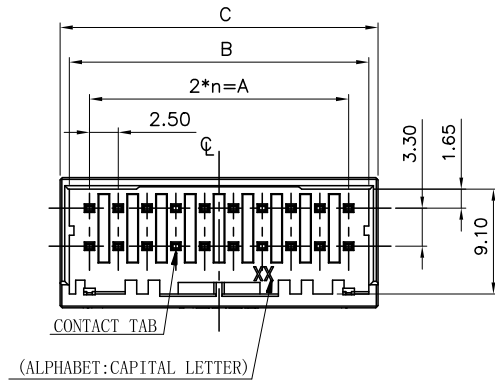
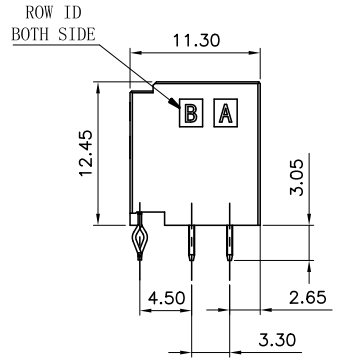
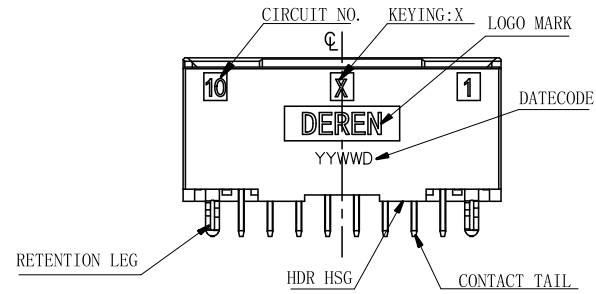

- RESERVE NUMBER
- PACKAGE CODE:
P: TUBE
R: REEL
T: TRAY
- LOGO MARK:
1: WITH DEREN LOGO
2: WITHOUT LOGO
- PLATING CODE:
4: Au :15u"
6: Sn :OVER TIN
- HOUSING COLOR:
1: BLACK
2: WHITE
- WATER CODE: 001~ZZZ
- POS CODE: 20POS: 0L
16POS: 0G
12POS: 0C
10POS: 0A
08POS: 08
06POS: 06
04POS: 04

20POS:560LBG-007H****V000

20	X	9	22.5	26.0	27.6	560LBG-007H****V000	560LBG-008H****00000
16	X	7	17.5	21.0	22.6	560GBG-003H****V000	560GBG-005H****00000
12	X	5	12.5	16.0	17.6	560CBG-003H****V000	560CBG-005H****00000
10	X	4	10.0	13.5	15.1	560ABG-007H****V000	560ABG-009H****00000
08	X	3	7.5	11.0	12.6	5608BG-002H****V000	5608BG-003H****00000
06	X	2	5.0	8.5	10.1	5606BG-003H****V000	5606BG-005H****00000
04	X	1	2.5	6.0	7.6	5604BG-003H****V000	5604BG-004H****00000
POS	KEY	n	A	B	C	MALE PART NO.	FAMALE PART NO.

DIM	TOL	DIM	TOL
x.	±0.30	x.	±5°
.x	±0.30	.x	±3°
.xx	±0.30		

DEREN
SHENZHEN DEREN ELECTRONIC CO., LTD

DRAW NO. ***	DESIGN:	Tanghaibo	DATE	2023.05.21	TITLE:	WTB Male 04~20P 15H Pitch2.5 180°DIP ASSY
	CHECK:				P/N:	56**BG-***H****V000
REV.	X4	APPROVAL:			SHEET:	1/2
					SCALE:	1:1
					UNIT:	mm

HF
Halogen Free

REV.	ECN NO.	LOCATION	DESCRIPTION	DATE	DESIGN
X1			INITIAL RELEASE	2022.09.08	Tanghaibo
X2		1/2	新增规格	2022.11.08	Tanghaibo
X3		1/3	修改编码电镀选项	2023.02.17	Tanghaibo
X4		1/4	更新图面	2023.05.21	Tanghaibo

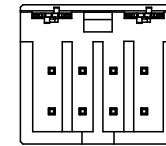
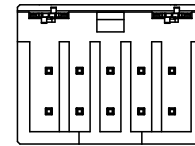
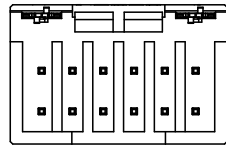
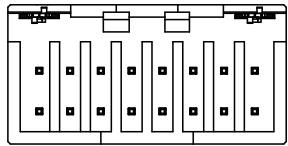
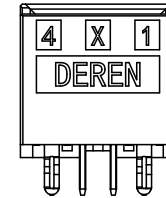
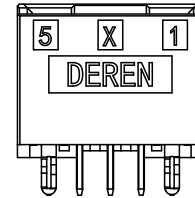
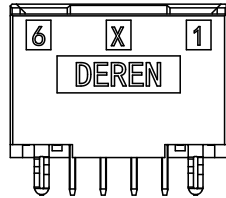
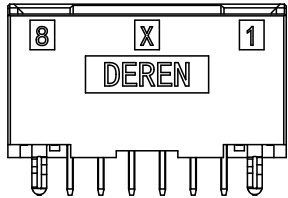
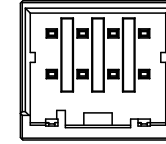
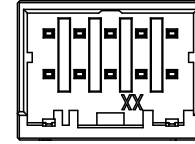
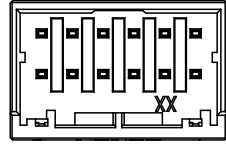
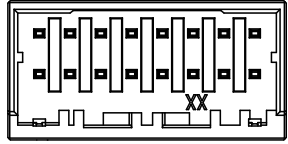

16POS:560GBG-003H****V000

12POS:560CBG-003H****V000

10POS:560ABG-007H****V000

08POS:5608BG-002H****V000

DIM	TOL	DIM	TOL
x.	±0.30	x.	±5°
.x	±0.30	.x	±3°
.xx	±0.30		

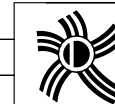

DEREN
SHENZHEN DEREN ELECTRONIC CO., LTD

DRAW NO.

INSPECTION DRAWING

DESIGN: Tanghaibo

CHECK:

APPROVAL:

DATE: 2023.05.21

TITLE: WTB Male XXP 15H Pitch2.5 180°DIP ASSY

P/N: 56**BG-***H****V000

SHEET: 2/3

SCALE: 1:1 UNIT: mm

HF
Halogen Free

REV.	ECN NO.	LOCATION	DESCRIPTION	DATE	DESIGN
X1			INITIAL RELEASE	2022.09.08	Tanghaibo
X2		1/2	新增规格	2022.11.08	Tanghaibo
X3		1/3	修改编码电镀选项	2023.02.17	Tanghaibo
X4		1/4	更新图面	2023.05.21	Tanghaibo

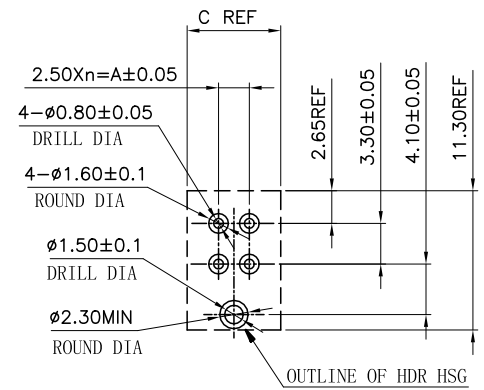
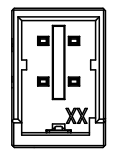
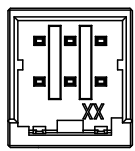

RECOMMEND PC BOARD HOLE PATTERN:
CONNECTOR MOUNT SIDE
(NOT ACCUMULATE TOLERANCE)
PC BOARD THICKNESS: 1.0~1.6±0.10
ONLY 4POS

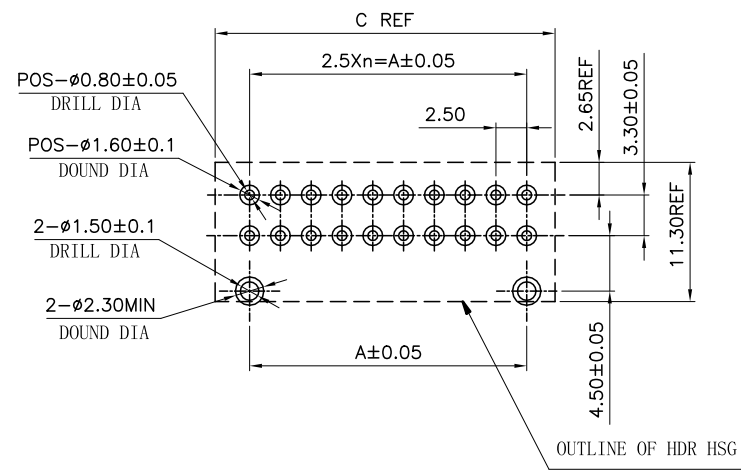

RECOMMEND PC BOARD HOLE PATTERN:
CONNECTOR MOUNT SIDE
(NOT ACCUMULATE TOLERANCE)
PC BOARD THICKNESS: 1.0~1.6±0.10

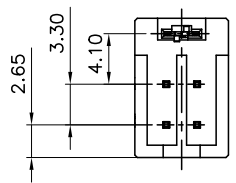
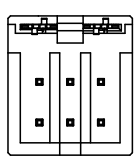
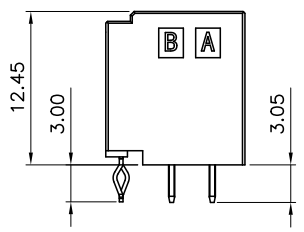
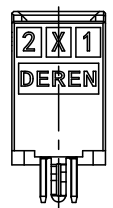
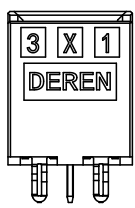

06POS:5606BG-003H****V000

04POS:5604BG-003H****V000

DIM	TOL	DIM	TOL
.x.	±0.30	.x.	±5°
.x	±0.30	.x	±3°
.xx	±0.30		

DEREN
SHENZHEN DEREN ELECTRONIC CO., LTD

INSPECTION	DRAWING	DATE	TITLE: WTB Male XXP 15H Pitch2.5 180°DIP ASSY
DESIGN:	Tanghaibo	2023.05.21	P/N: 56**BG-***H****V000
CHECK:			SHEET: 3/3
REV. X5	APPROVAL:		SCALE: 1:1 UNIT: mm