



# 深圳市凯越翔电子有限公司

## 石英谐振器规格书

产品名称:	石英晶振谐振器
产品型号:	2016/25.000MHZ
产品参数:	10PF/±10PPM
原厂型号:	K2B250001010
凯越翔技术部:	董宗全

### 客户确认印栏

认证印章	负责人印章
年 月 日	年 月 日

本规格章程连同本页合共 5 页

- |  |                            |
|--|----------------------------|
| 1. Frequency:                                  | <b>25.000 MHZ</b>          |
| 2. Holder Type:                                | SMD2.0*1.6                 |
| 3. Frequency Tolerance:                        | <b>±10ppm at 25°C ±3°C</b> |
| 4. Equivalent Series Resistance:               | <b>40 Ω Max</b>            |
| 5. Storage Temperature Range:                  | -40°C ~ +85°C              |
| 6. Operating Temperature Range:                | -40°C ~ +85°C              |
| 7. Frequency Characteristics Over Temperature: | ±20ppm -40°C ~ +85°C       |
| 8. Load Capacitance (CL):                      | 10 PF                      |
| 9. Drive Level:                                | 100 μ W                    |
| 10. Shunt Capacitance:                         | 5PF MAX                    |
| 11. Insulation Resistance:                     | ≥500M Ω Min at 100 V       |
| 12. Mode Of Oscillation:                       | Fundamental                |
| 13. Aging:                                     | ±3ppm/Year                 |
| Marking description:                           | KYX25.000                  |
| 14. Dimensions(mm):                            |                            |

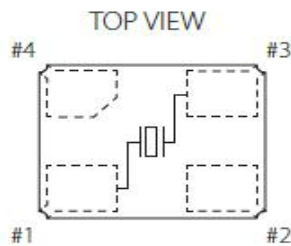
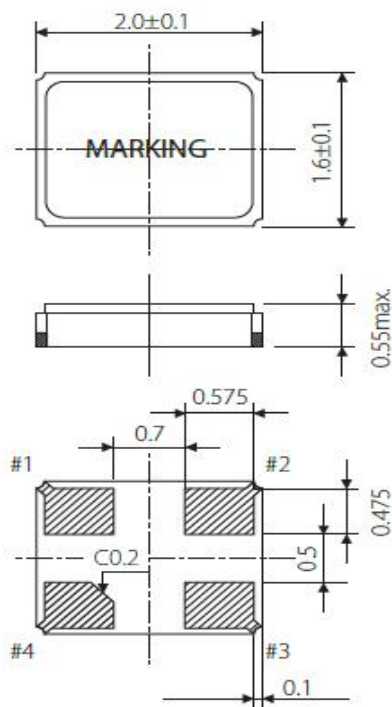

• #1,#3 : Crystal terminal / #2,#4 : Connected to cover  
(Please connect it with GND.)

Example of a Terminal Land Pattern

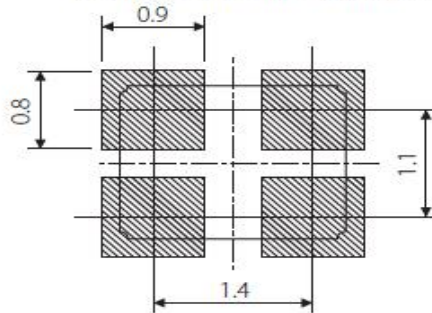

16. Structure Illustration

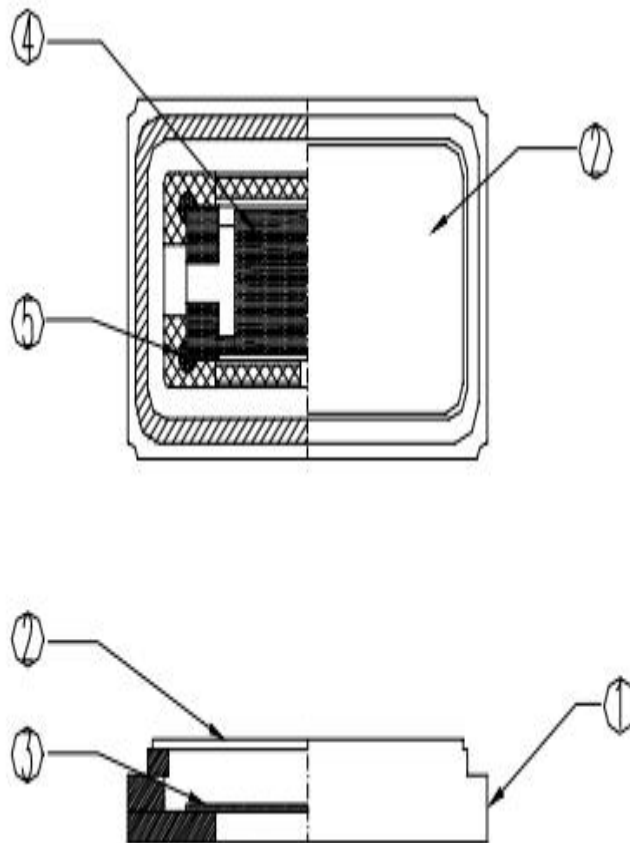

PART NAME		MATERIAL	PART NAME		MATERIAL
1.	BASE	CERAMIC	4.	ELECTRODE	Metal
2.	LID	Co	5.	ADHESMES	SILVER GLUE
3.	BLANK	QUARTZ			

## Reliability Testing 可靠性测试项目介绍

项目	验条件及要求	要求
Vibration 振动	Endurance condition by a frequency sweep shall be made. The entire frequency range from 10HZ to 50HZ and return to 10HZ, shall be transverse in 1min. Amplitude(total excursion):1.5mm this motion shall be applied for a period of 2h each of 3 mutually perpendicular axes(a total of 6h) 振动频率: 从 10HZ 到 55HZ, 再回到 10HZ 1 倍频程/min 幅度为 1.5mm 3 个相互垂直的方向各 2 小时	(1). FL: +/-10ppm (2). Rr: +/-10 Ω
Drop 跌落	Form 70cm height 3 times on 3cm hard wooden floor 从 70cm 高处跌落到 3cm 厚的硬质木板上, 重复 3 次	
Shock 冲击	Peak acceleration:981m/s <sup>2</sup> duration of the pulse :6ms three successive shocks shall be applied in both direction of 3 mutually perpendicular axes(a total of 18 shocks) 加速度: 981m/s <sup>2</sup> 时间: 6ms 作用在 3 个相互垂直的方向	(1). FL: +/-10ppm (2). Rr: +/-10 Ω
Damp heat, constant 恒定湿热	The unit shall be stored at a temperature of 40℃ ±2℃ with relative humidity of 90%to95% for 48h, then it shall be subjected to standard atmospheric conditions for 1~2h after which measurement shall be made. 在温度: 40℃ ±2℃、湿度: 90%to95%条件下存放 48 小时, 然后在标准大气压下放置 1~2 小时后测试	
Cold 低温存储	The unit shall be stored at a temperature of -40℃ ±5℃ for 48h, then it shall be subjected to standard atmospheric conditions for 1~2h after which measurement shall be made. 在 -40℃ ±5℃ 下存放 48 小时, 然后在标准大气压下放置 1~2 小时后测试	
Dry heat 高温存储	The unit shall be stored at a temperature of 100℃ ±5℃ for 24h, then it shall be subjected to standard atmospheric conditions for 1~2h after which measurement shall be made. 100℃ ±5℃ 下存放 24 小时, 然后在标准大气压下放置 1~2 小时后测试	
Aging 老化	The unit shall be stored at a temperature of 85℃ ±5℃ for 7d then it shall be subjected to standard atmospheric conditions for 1~2h after which measurement shall be made. 85℃ ±5℃ 下放置 7 天, 然后在标准大气压下放置 1~2 小时后测试	
Temperature cycling	The unit shall be subjected to 5 successive change of temperature cycles, each as show in table below, then it shall be subjected to standard atmospheric conditions for 1~2h after which measurement shall be made 在下表给定温度和时间参数的条件下循环 5 次, 标准大气压下放置 1~2 小时后测试	

凯越翔

温度循环	Temperature 温度	Duration 放置时间
1	-40°C ± 3°C	30min (30 分钟)
2	Standard atmospheric conditions 标准大气压	Within 30s 30 秒内
3	100°C ± 3°C	30min (30 分钟)
4	Standard atmospheric conditions 标准大气压	Within 30s 30 秒内

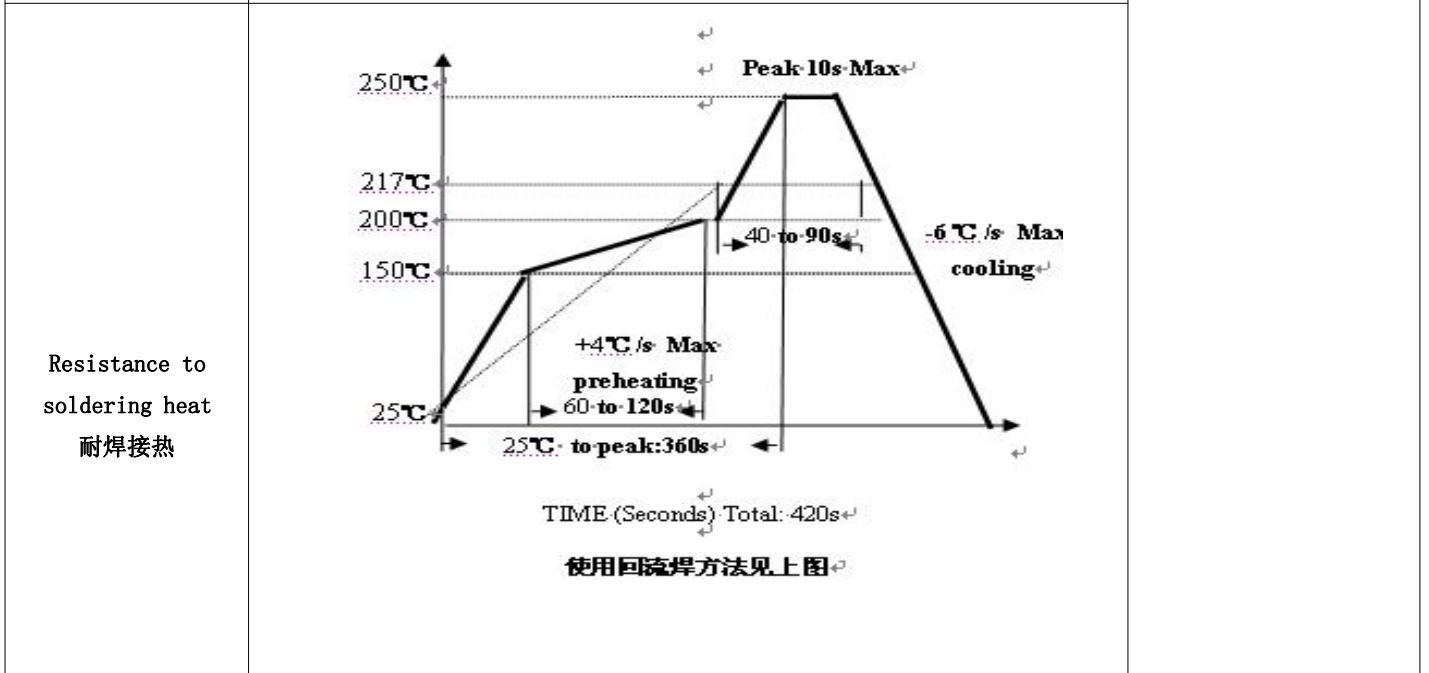

2. REEL : 3000 PCS

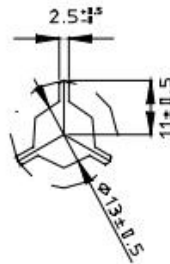
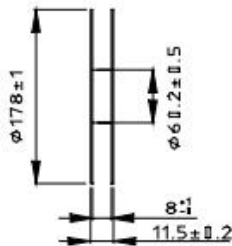
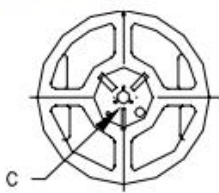

拟制	成望生	审核	董宗全	批准	谢为亮
----	-----	----	-----	----	-----