



深圳市凯越翔电子有限公司

石英谐振器规格书

产品名称:	石英晶振谐振器
产品型号:	2016/27.120MHZ
产品参数:	7.5PF/±10PPM
原厂型号:	K2B271207510
凯越翔技术部:	董宗全

客户确认印栏

认证印章	负责人印章
年 月 日	年 月 日

本规格章程连同本页合共5页

- | | |
|--|----------------------------|
| 1. Frequency: | 27.120 MHZ |
| 2. Holder Type: | SMD2.0*1.6 |
| 3. Frequency Tolerance: | ±10ppm at 25°C ±3°C |
| 4. Equivalent Series Resistance: | 40 Ω Max |
| 5. Storage Temperature Range: | -40°C ~ +85°C |
| 6. Operating Temperature Range: | -40°C ~ +85°C |
| 7. Frequency Characteristics Over Temperatnre: | ±20ppm -40°C ~+85°C |
| 8. Load Capacitance (CL): | 7.5 PF |
| 9. Drive Level: | 100 μ W |
| 10. Shunt Capacitance: | 5PF MAX |
| 11. Insulation Resistance: | ≥500M Ω Min at 100 V |
| 12. Mode Of Oscillation: | Fundamental |
| 13. Aging: | ±3ppm/Year |
| Marking description: | KYX27.120 |
| 14. Dimensiors(mm): | |

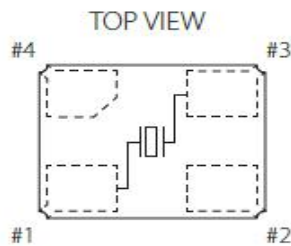
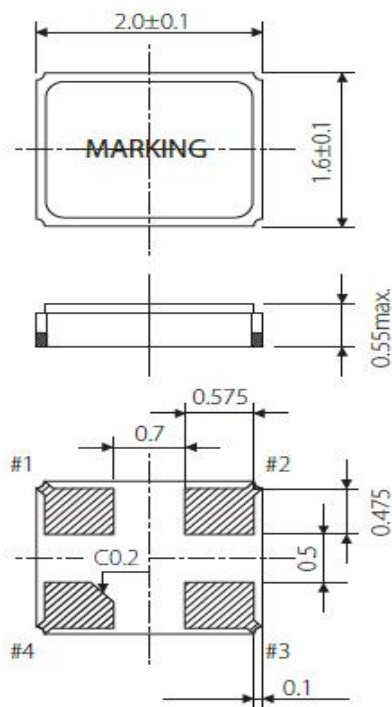

• #1,#3 : Crystal terminal / #2,#4 : Connected to cover
(Please connect it with GND.)

Example of a Terminal Land Pattern

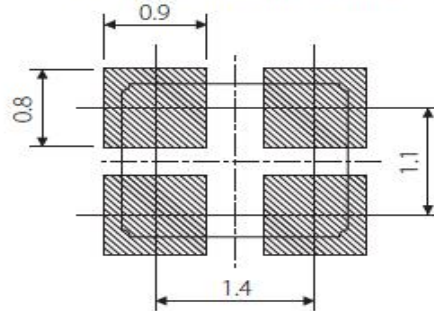

16. Structure Illustration

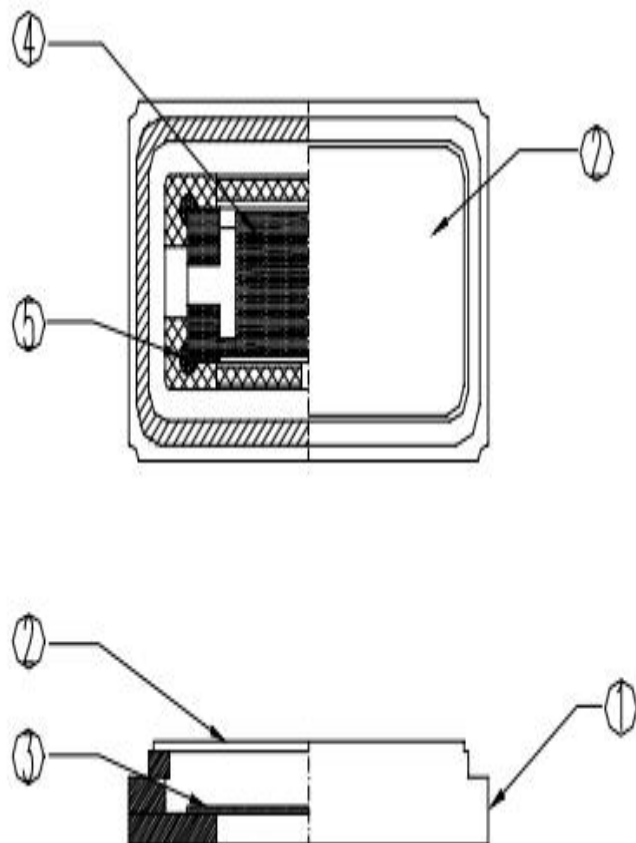

PART NAME		MATERIAL	PART NAME		MATERIAL
1.	BASE	CERAMIC	4.	ELECTRODE	Metal
2.	LID	Co	5.	ADHESMES	SILVER GLUE
3.	BLANK	QUARTZ			

Reliability Testing 可靠性测试项目介绍

项目	验条件及要求	要求
Vibration 振动	Endurance condition by a frequency sweep shall be made. The entire frequency range from 10HZ to 50HZ and return to 10HZ, shall be transverse in 1min. Amplitude(total excursion):1.5mm this motion shall be applied for a period of 2h each of 3 mutually perpendicular axes(a total of 6h) 振动频率: 从 10HZ 到 55HZ, 再回到 10HZ 1 倍频程/min 幅度为 1.5mm 3 个相互垂直的方向各 2 小时	(1). FL: +/-10ppm (2). Rr: +/-10 Ω
Drop 跌落	Form 70cm height 3 times on 3cm hard wooden floor 从 70cm 高处跌落到 3cm 厚的硬质木板上, 重复 3 次	
Shock 冲击	Peak acceleration:981m/s ² duration of the pulse :6ms three successive shocks shall be applied in both direction of 3 mutually perpendicular axes(a total of 18 shocks) 加速度: 981m/s ² 时间: 6ms 作用在 3 个相互垂直的方向	(1). FL: +/-10ppm (2). Rr: +/-10 Ω
Damp heat, constant 恒定湿热	The unit shall be stored at a temperature of 40℃ ±2℃ with relative humidity of 90%to95% for 48h, then it shall be subjected to standard atmospheric conditions for 1~2h after which measurement shall be made. 在温度: 40℃ ±2℃、湿度: 90%to95%条件下存放 48 小时, 然后在标准大气压下放置 1~2 小时后测试	
Cold 低温存储	The unit shall be stored at a temperature of -40℃ ±5℃ for 48h, then it shall be subjected to standard atmospheric conditions for 1~2h after which measurement shall be made. 在 -40℃ ±5℃ 下存放 48 小时, 然后在标准大气压下放置 1~2 小时后测试	
Dry heat 高温存储	The unit shall be stored at a temperature of 100℃ ±5℃ for 24h, then it shall be subjected to standard atmospheric conditions for 1~2h after which measurement shall be made. 100℃ ±5℃ 下存放 24 小时, 然后在标准大气压下放置 1~2 小时后测试	
Aging 老化	The unit shall be stored at a temperature of 85℃ ±5℃ for 7d then it shall be subjected to standard atmospheric conditions for 1~2h after which measurement shall be made. 85℃ ±5℃ 下放置 7 天, 然后在标准大气压下放置 1~2 小时后测试	
Temperature cycling	The unit shall be subjected to 5 successive change of temperature cycles, each as show in table below, then it shall be subjected to standard atmospheric conditions for 1~2h after which measurement shall be made 在下表给定温度和时间参数的条件下循环 5 次, 标准大气压下放置 1~2 小时后测试	

凯越翔

温度循环		Temperature 温度	Duration 放置时间
	1	-40°C ± 3°C	30min (30 分钟)
	2	Standard atmospheric conditions 标准大气压	Within 30s 30 秒内
	3	100°C ± 3°C	30min (30 分钟)
	4	Standard atmospheric conditions 标准大气压	Within 30s 30 秒内

Resistance to soldering heat 耐焊接热	<p>250°C 217°C 200°C 150°C 25°C</p> <p>Peak 10s Max</p> <p>+4°C/s Max preheating</p> <p>-6°C/s Max cooling</p> <p>40 to 90s</p> <p>60 to 120s</p> <p>25°C to peak: 360s</p> <p>TIME (Seconds) Total: 420s</p> <p>使用回流焊方法见上图</p>
--------------------------------------	---

2. REEL : 3000 PCS

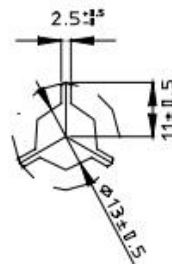
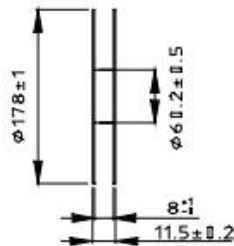
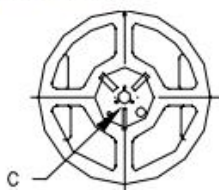

拟制	成望生	审核	董宗全	批准	谢为亮
----	-----	----	-----	----	-----