

Base strip - MSTBA 2,5/ 7-G-5,08 - 1757297

Please be informed that the data shown in this PDF Document is generated from our Online Catalog. Please find the complete data in the user's documentation. Our General Terms of Use for Downloads are valid (<http://phoenixcontact.com/download>)

Header, Nominal current: 12 A, Rated voltage (III/2): 320 V, Number of positions: 7, Pitch: 5.08 mm, Color: green, Contact surface: Tin, Mounting: Wave soldering



The figure shows a 10-position version of the product

Product Features

- Other pin lengths available on request
- Plug-in direction parallel to the conductor axis
- W type with stand-off
- Standard pin strip for 320 V (III/2)



Key Commercial Data

Packing unit	1 pc
GTIN	 4 017918 029821
Weight per Piece (excluding packing)	2.8 g
Custom tariff number	85366990
Country of origin	Germany

Technical data

Dimensions

Length	12 mm
Pitch	5.08 mm
Dimension a	30.48 mm
Width	37.48 mm
Constructional height	8.6 mm

Base strip - MSTBA 2,5/ 7-G-5,08 - 1757297

Technical data

Dimensions

Height	12.1 mm
Length of the solder pin	3.5 mm
Pin dimensions	1 x 1 mm
Hole diameter	1.4 mm

General

Range of articles	MSTBA 2,5/...-G
Insulating material group	I
Rated surge voltage (III/3)	4 kV
Rated surge voltage (III/2)	4 kV
Rated surge voltage (II/2)	4 kV
Rated voltage (III/3)	250 V
Rated voltage (III/2)	320 V
Rated voltage (II/2)	400 V
Connection in acc. with standard	EN-VDE
Nominal current I_N	12 A
Maximum load current	12 A
Insulating material	PA
Flammability rating according to UL 94	V0
Color	green
Number of positions	7

Standards and Regulations

Connection in acc. with standard	EN-VDE
	CSA
Flammability rating according to UL 94	V0

Classifications

eCl@ss

eCl@ss 4.0	272607xx
eCl@ss 4.1	27260701
eCl@ss 5.0	27260701
eCl@ss 5.1	27260701
eCl@ss 6.0	27260704
eCl@ss 7.0	27440402
eCl@ss 8.0	27440402
eCl@ss 9.0	27440402

Base strip - MSTBA 2,5/ 7-G-5,08 - 1757297

Classifications

ETIM

ETIM 3.0	EC001121
ETIM 4.0	EC002637
ETIM 5.0	EC002637

UNSPSC

UNSPSC 6.01	30211810
UNSPSC 7.0901	39121409
UNSPSC 11	39121409
UNSPSC 12.01	39121409
UNSPSC 13.2	39121409

Approvals

Approvals

Approvals

CSA / VDE Gutachten mit Fertigungsüberwachung / IECCEB Scheme / EAC / cULus Recognized / EAC

Ex Approvals

Approvals submitted

Approval details

CSA 		
	B	D
Nominal current I _N	15 A	10 A
Nominal voltage U _N	300 V	300 V

VDE Gutachten mit Fertigungsüberwachung 	
Nominal current I _N	12 A

Base strip - MSTBA 2,5/ 7-G-5,08 - 1757297

Approvals

Nominal voltage UN	250 V
--------------------	-------

IECEE CB Scheme	
Nominal current IN	12 A
Nominal voltage UN	250 V

EAC

cULus Recognized		
	B	D
Nominal current IN	15 A	10 A
Nominal voltage UN	300 V	300 V

EAC

Drawings

Drilling diagram

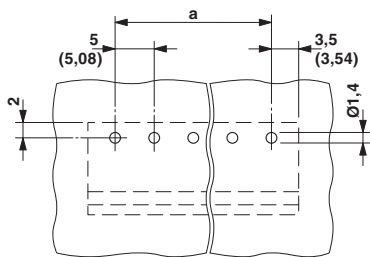

Diagram

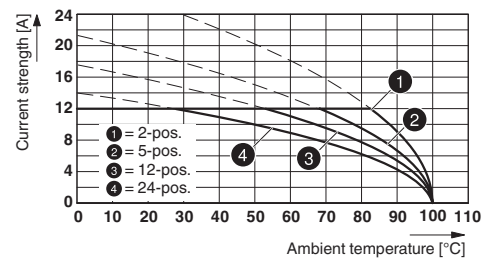

Type: ICV 2,5/..-G-5,08 with MSTBA 2,5/..-G-5,08

Base strip - MSTBA 2,5/ 7-G-5,08 - 1757297

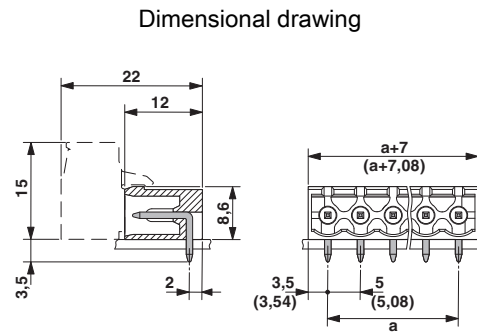
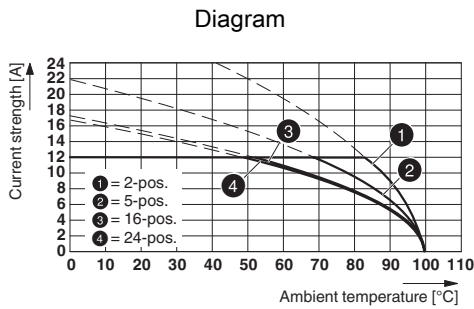

Type: IC 2,5/...-G-5,08 with MSTBA 2,5/...-G-5,08

Diagram

Plug: QC 1/5-ST(F)-5,08
 Header: MSTB(A) 2,5/5-G(F)-5,08

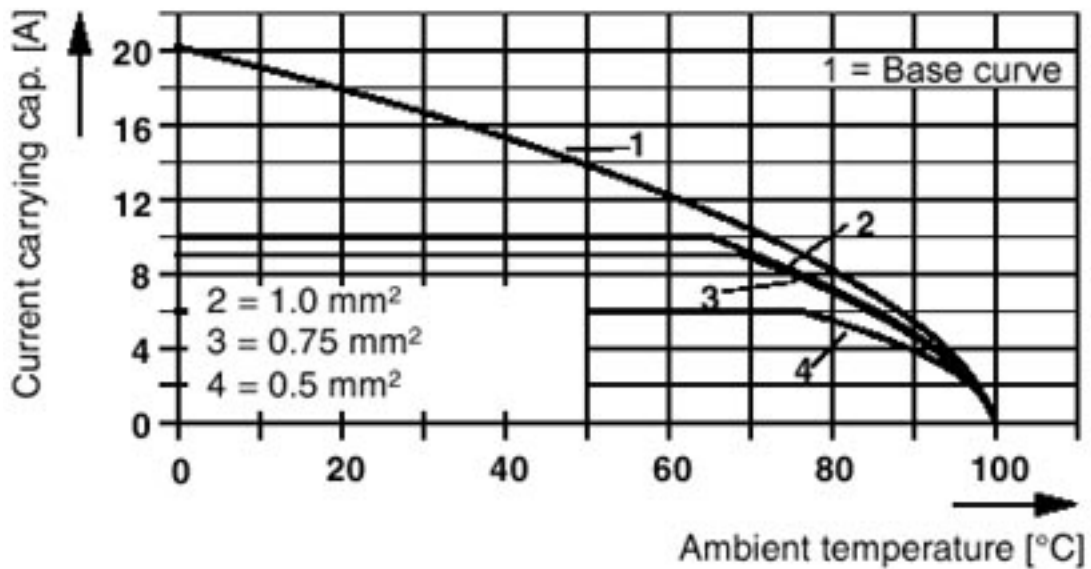

Base strip - MSTBA 2,5/ 7-G-5,08 - 1757297

Diagram

Plug: MSTBT 2,5/5-ST(F)-(-5,08)
Header: MSTB(A) 2,5/5-G(F)-(-5,08)

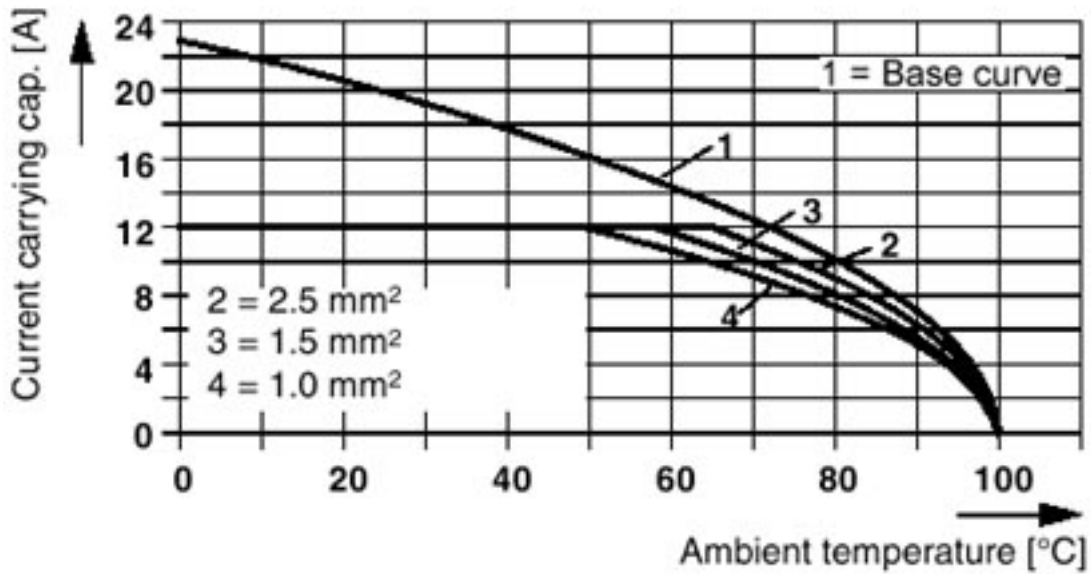

Diagram

Plug: SMSTB 2,5/5-ST(F)-(-5,08)
Header: MSTB(A) 2,5/5-G(F)-(-5,08)

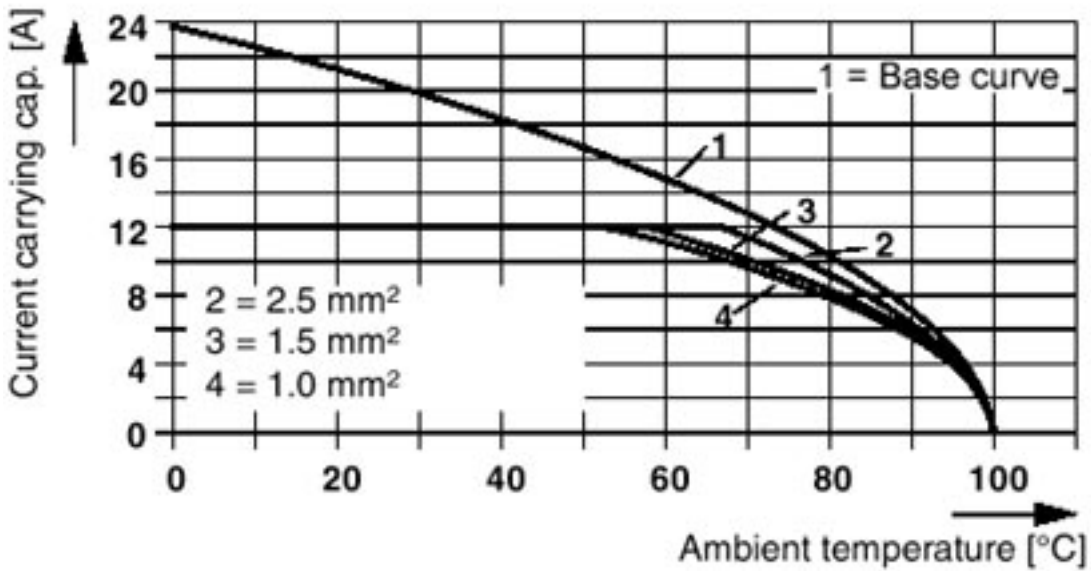

Base strip - MSTBA 2,5/ 7-G-5,08 - 1757297

Diagram

Plug: MVSTBR(W) 2,5/5-ST(F)-(-5,08)
Header: MSTB(A) 2,5/5-G(F)-(-5,08)

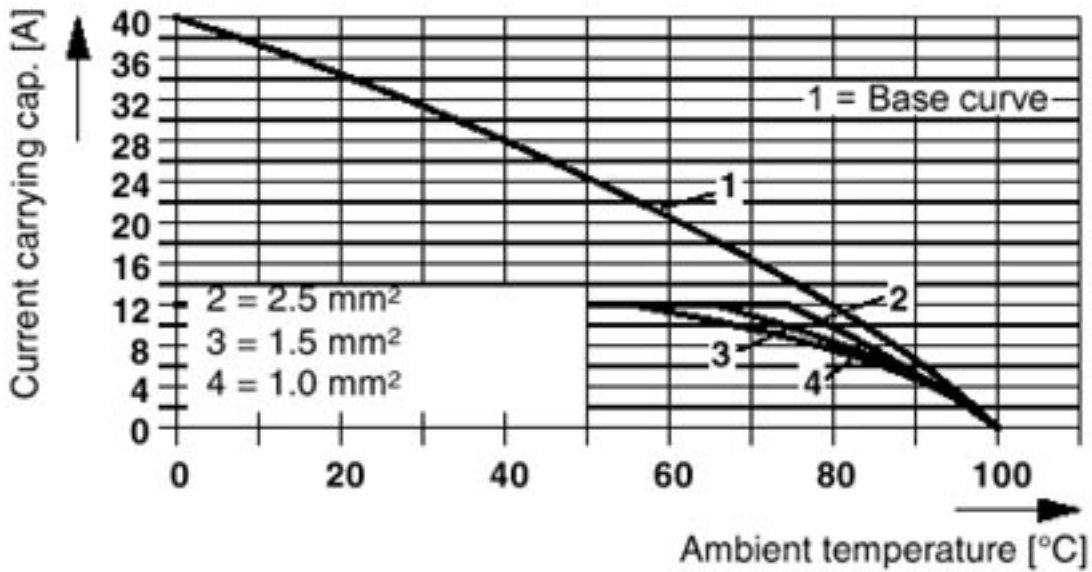

Diagram

Plug: FRONT-MSTB 2,5/5-ST(F)-(-5,08)
Header: MSTB(A) 2,5/5-G(F)-(-5,08)

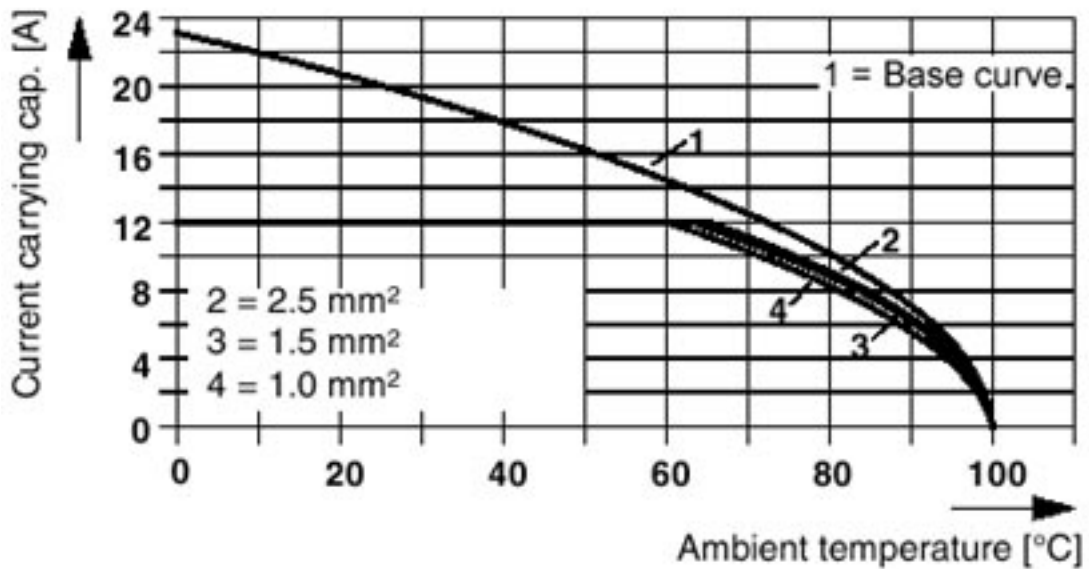

Base strip - MSTBA 2,5/ 7-G-5,08 - 1757297

Diagram

Plug: TMSTBP 2,5/5-ST(F)-(-5,08)
Header: MSTB(A) 2,5/5-G(F)-(-5,08)

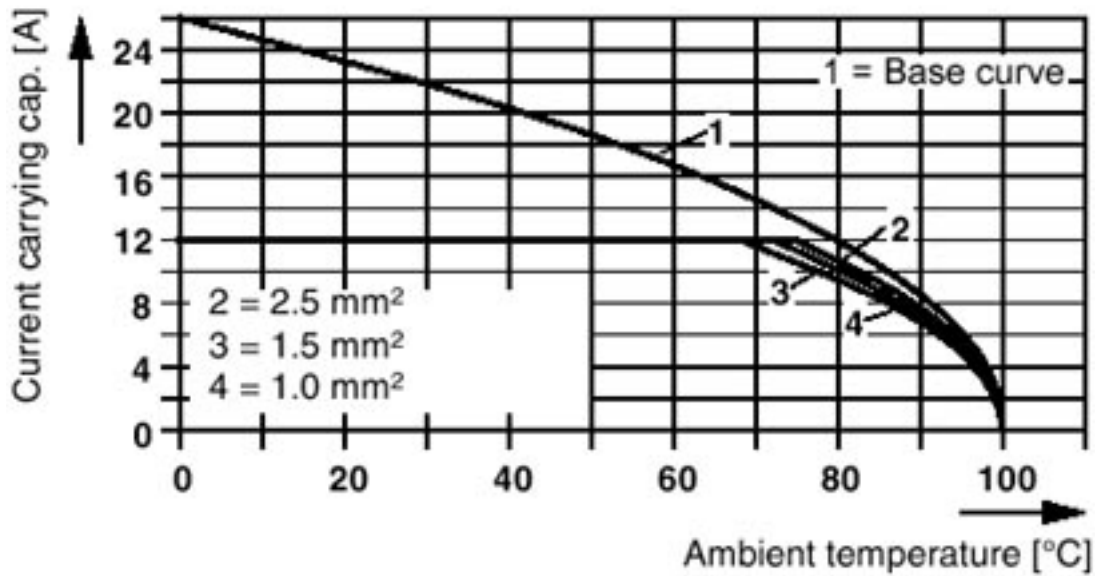

Diagram

Plug: FKC 2,5/5-ST(F)-5,08
Header: MSTB(A) 2,5/5-G(F)-5,08

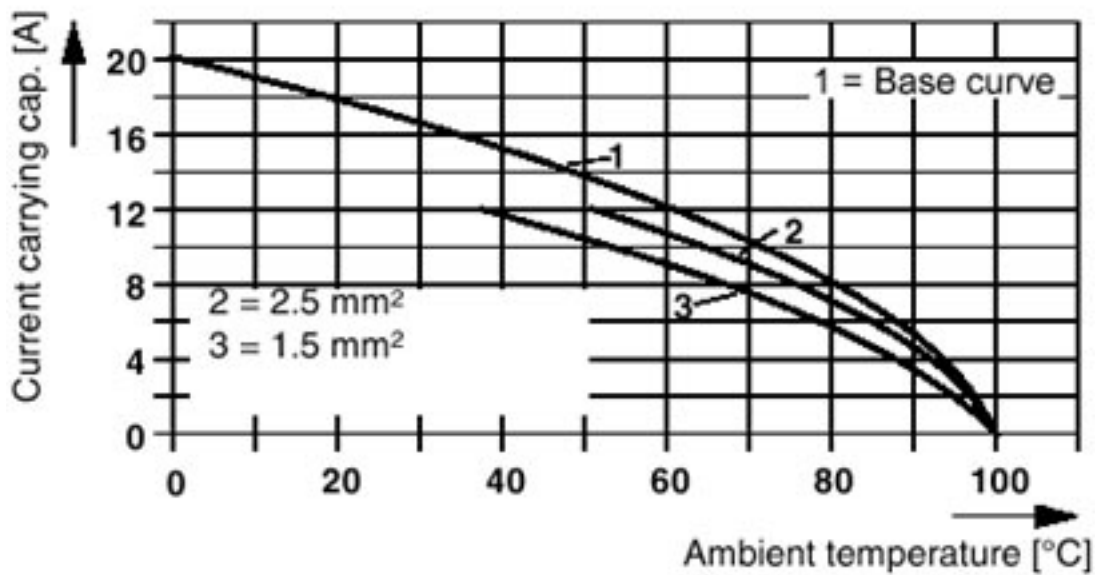

Base strip - MSTBA 2,5/ 7-G-5,08 - 1757297

Diagram

Plug: FKCVR(W) 2,5/5-ST(F)-5,08
Header: MSTB(A) 2,5/5-G(F)-5,08

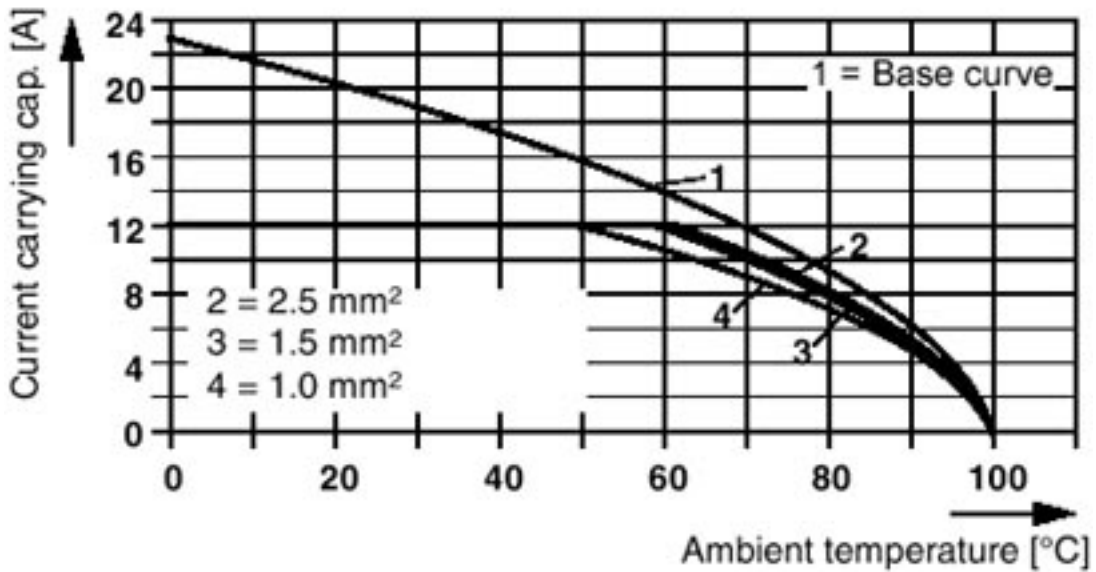

Diagram

Plug: MSTB 2,5/5-ST(F)(-5,08)
Header: MSTBO 2,5/5-GR(L)(-5,08)

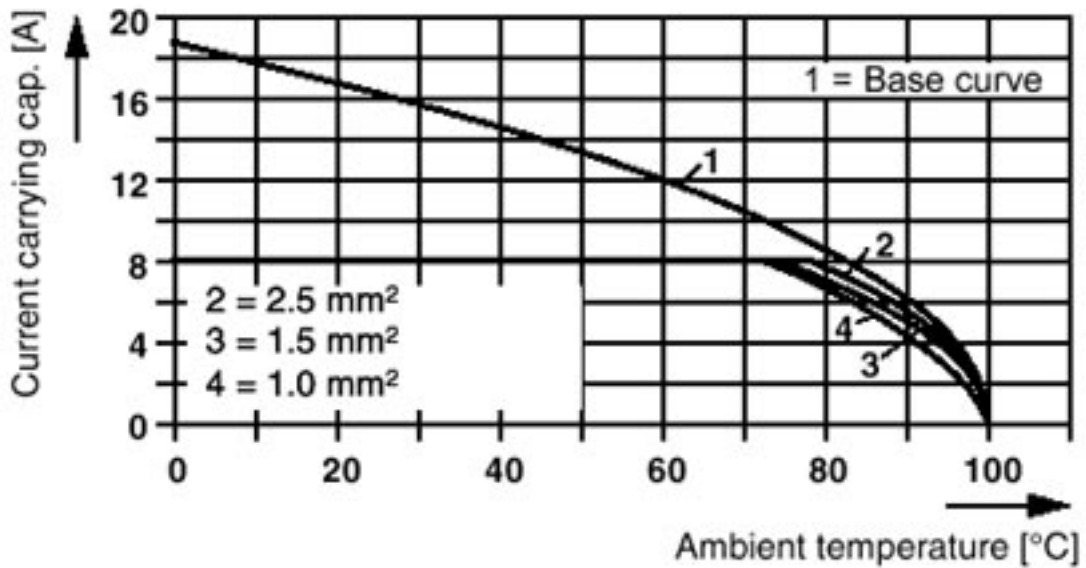

Base strip - MSTBA 2,5/ 7-G-5,08 - 1757297

Diagram

Plug: MSTB 2,5/5-ST(F)-(-5,08)
Header: MSTB(A) 2,5/5-G(F)-(-5,08)

