

# ASMT-Ax00

## 1W Power LED Light Source



### Data Sheet



Lead (Pb) Free  
RoHS 6 fully  
compliant



#### Description

The ASMT-Ax00 series of 1W Power LEDs are high performance energy efficient devices which can handle high driving current and high temperatures. The exposed pad design enables excellent heat transfer from the package to the motherboard. An electrically isolated metal slug option is also available.

The White Power LED is available with color temperatures ranging from 2700K to 10000K.

The low profile package design is suitable for a wide variety of applications especially where height is a constraint and the package foot print is compatible with most high power LEDs available in the market today.

This package is compatible with reflow soldering process.

#### Features

- Available in Red, Red Orange, Amber, Blue, Royal Blue, Cyan, Green, Cool White, Neutral White and Warm White color
- Energy efficient
- Exposed metal slug for excellent heat transfer
- Compatible with reflow soldering process
- High current operation
- Long operation life
- Wide viewing angle at 140°
- Silicone encapsulation
- Non-ESD sensitive (threshold > 16 kV)
- MSL 2a products

#### Applications

- Architectural lighting
- Channel backlighting
- Contour lighting
- Retail Display lighting
- Decorative lighting
- Garden lighting

## Package Dimensions

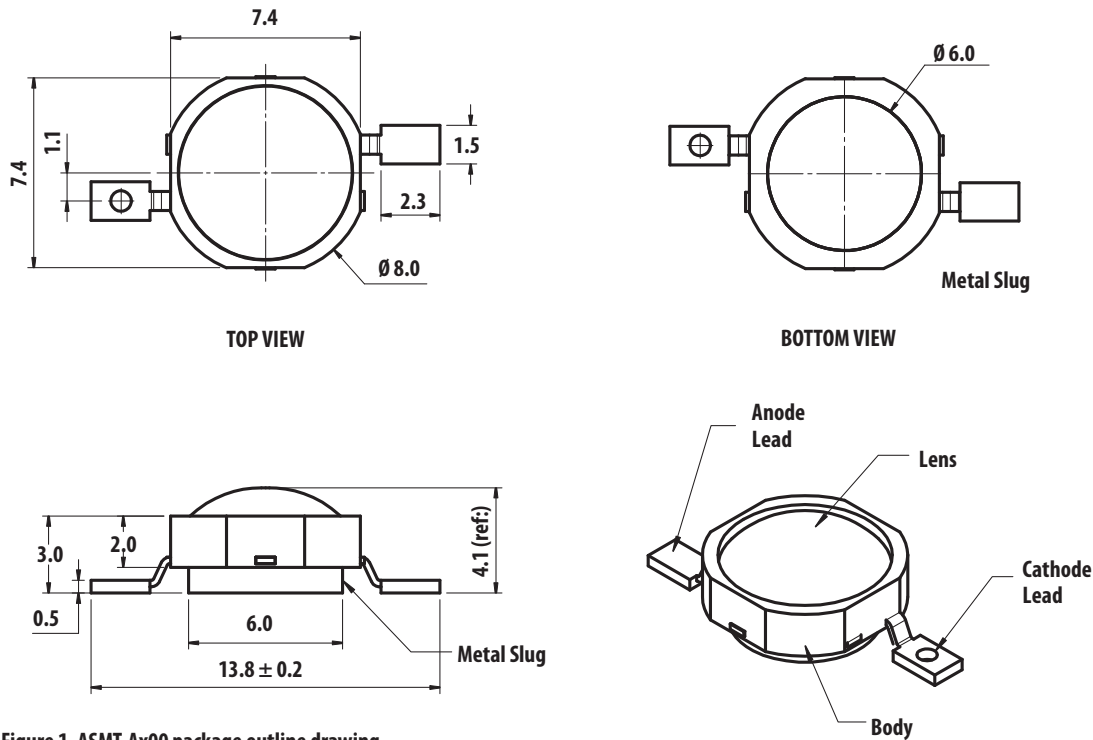
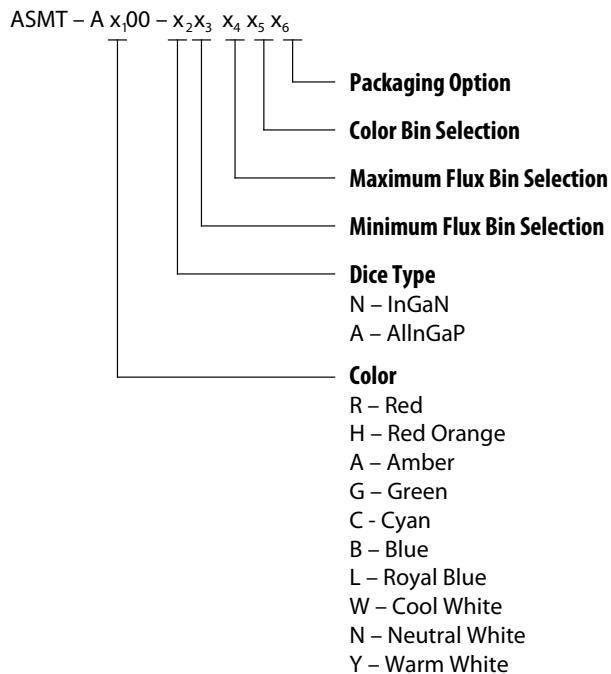

Figure 1. ASMT-Ax00 package outline drawing.

Notes:

1. All dimensions in millimeters.
2. Metal slug is connected to anode for electrically non-isolated option.
3. Tolerance is  $\pm 0.1$  mm unless otherwise specified.
4. Terminal Finish: Ag plating

## Part Numbering System



Note:

1. Please refer to Page 10 for selection details.

## Device Selection Guide ( $T_j = 25\text{ }^\circ\text{C}$ )

Part Number	Color	Luminous Flux (lm) / Radiometric Power (mW), $\Phi_V$ <sup>[1,2]</sup>			Test Current (mA)	Dice Technology	Electrically Isolated Metal Slug
		Min.	Typ.	Max.			
ASMT-AR00-ARS00	Red	39.8	50.0	67.2	350	AlInGaP	No <sup>[3]</sup>
ASMT-AR00-AST00		51.7	65.0	87.4			
ASMT-AH00-ARS00	Red Orange	39.8	50.0	67.2	350	AlInGaP	No <sup>[3]</sup>
ASMT-AA00-ARS00	Amber	39.8	50.0	67.2	350	AlInGaP	No <sup>[3]</sup>
ASMT-AB00-NMP00	Blue	13.9	20.0	30.6	350	InGaN	Yes
ASMT-AL00-NNP00	Royal Blue	275 mW	350 mW	435 mW	350	InGaN	Yes
ASMT-AL00-NNQ00		275 mW	355 mW	515 mW			
ASMT-AC00-NSU00	Cyan	51.7	75.0	99.6	350	InGaN	Yes
ASMT-AG00-NST00	Green	51.7	65.0	87.4	350	InGaN	Yes
ASMT-AG00-NUV00		87.4	105.0	113.6			
ASMT-AW00-NUV00	Cool White	87.4	90.0	113.6	350	InGaN	Yes
ASMT-AN00-NUV00	Neutral White	87.4	90.0	113.6	350	InGaN	Yes
ASMT-AY00-NTU00	Warm White	67.2	80.0	99.6	350	InGaN	Yes
ASMT-AY00-NTV00		67.2	85.0	113.6			

Notes:

- $\Phi_V$  is the total luminous flux / radiometric power output as measured with an integrating sphere at 25 ms mono pulse condition.
- Flux and power tolerance is  $\pm 10\%$ .
- Electrically isolated metal slug option is also available. Please contact your Avago sale representative.

## Absolute Maximum Ratings

Parameter	AlInGaP	InGaN	InGaN Cyan	Units
DC Forward Current <sup>[1]</sup>	500	500	500	mA
Peak Pulsing Current <sup>[2]</sup>	1000	1000	1000	mA
Power Dissipation	1230	1830	1980	mW
LED Junction Temperature	125	135	135	$^\circ\text{C}$
Operating Ambient Temperature Range at 350mA	-40 to +115	-40 to +120	-40 to +120	$^\circ\text{C}$
Storage Temperature Range	-40 to +120	-40 to +120	-40 to +120	$^\circ\text{C}$
Soldering Temperature	Refer to Figure 26			
Reverse Voltage <sup>[3]</sup>	Not recommended			

Notes:

- Derate linearly based on Figure 10 for AlInGaP and Figure 22 for InGaN.
- Pulse condition duty factor = 10%, Frequency = 1 kHz.
- Not designed for reverse bias operation

### Optical Characteristics at 350 mA (T<sub>J</sub> = 25 °C)

Part Number	Color	Peak Wavelength, $\lambda_{PEAK}$ (nm)	Dominant Wavelength, $\lambda_D$ [1] (nm)	Viewing Angle, $2\theta_{1/2}$ [2] (°)	Luminous Efficiency (lm/W)
		Typ.	Typ.	Typ.	Typ.
ASMT-AR00-ARS00	Red	635	625	140	68
ASMT-AR00-AST00		635	625	140	88
ASMT-AH00-ARS00	Red Orange	625	615	140	68
ASMT-AA00-ARS00	Amber	598	590	140	68
ASMT-AG00-NST00	Green	519	525	140	58
ASMT-AG00-NUV00		519	525	140	94
ASMT-AC00-NSU00	Cyan	497	500	140	63
ASMT-AB00-NMP00	Blue	454	460	140	18
ASMT-AL00-NNP00	Royal Blue	450	455	140	Not applicable
ASMT-AL00-NNQ00		450	455	140	Not applicable

Part Number	Color	Correlated Color Temperature, CCT (Kelvin)		Viewing Angle, $2\theta_{1/2}$ [2] (°)	Luminous Efficiency (lm/W)
		Min.	Max.	Typ.	Typ.
ASMT-AW00-NUV00	Cool White	4500	10000	140	80
ASMT-AN00-NUV00	Neutral White	3500	4500	140	80
ASMT-AY00-NTU00	Warm White	2700	3500	140	71
ASMT-AY00-NTV00		2700	3500	140	76

Notes:

1. The dominant wavelength,  $\lambda_D$ , is derived from the CIE Chromaticity Diagram and represents the color of the device.
2.  $\theta_{1/2}$  is the off-axis angle where the luminous intensity is 1/2 the peak intensity.

### Electrical Characteristic at 350 mA (T<sub>J</sub> = 25 °C)

Dice Type	Forward Voltage, V <sub>F</sub> (Volts)			Thermal Resistance, R <sub>θj-ms</sub> (°C/W) [1]
	Min.	Typ	Max.	Typ.
AllInGaP	1.7	2.1	2.3	10
InGaN (non-Cyan colors)	2.8	3.2	3.5	10
InGaN Cyan	3.0	3.4	3.8	10

Notes:

1. R<sub>θj-ms</sub> is Thermal Resistance from LED junction to metal slug.

# AlInGaP

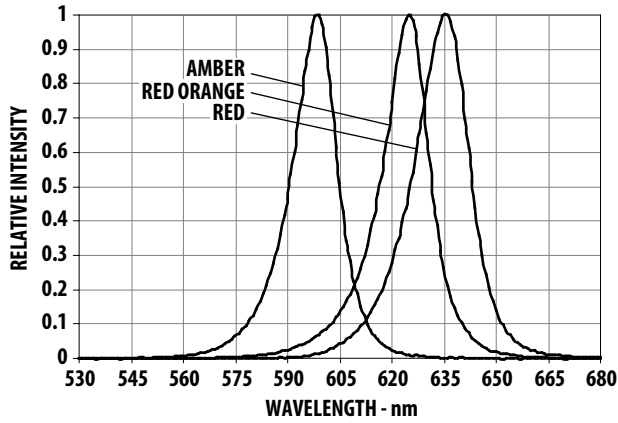

Figure 2. Relative Intensity vs. Wavelength for Red, Red Orange and Amber.

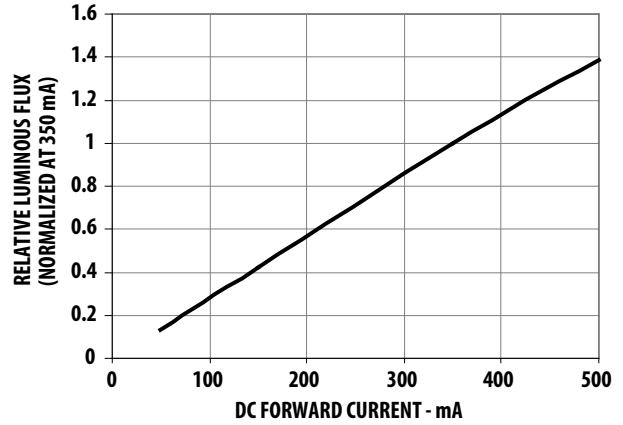

Figure 3. Relative Luminous Flux vs. Mono Pulse Current.

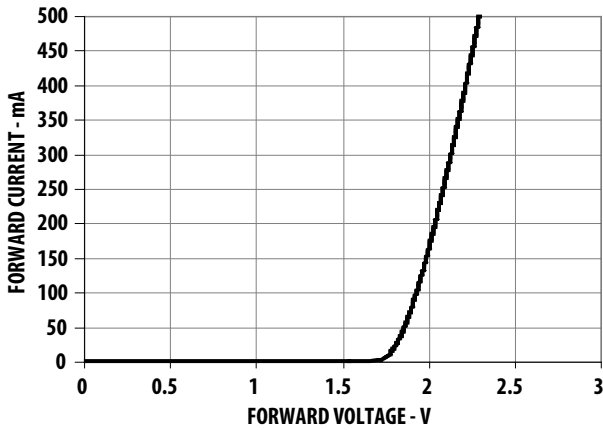

Figure 4. Forward Current vs. Forward Voltage.

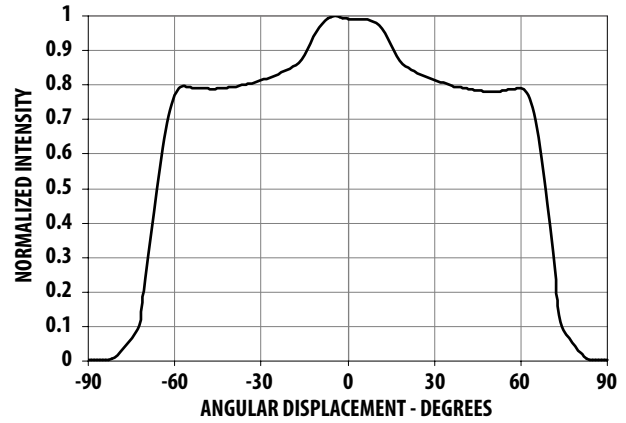

Figure 5. Radiation Pattern for Red, Red Orange and Amber.

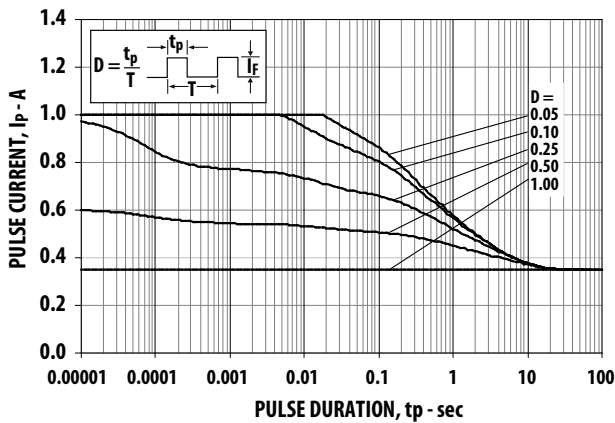

Figure 6. Maximum pulse current vs. pulse duration. Derated based on  $T_A = 25^\circ\text{C}$ ,  $R\theta_{J-A} = 50^\circ\text{C/W}$ .

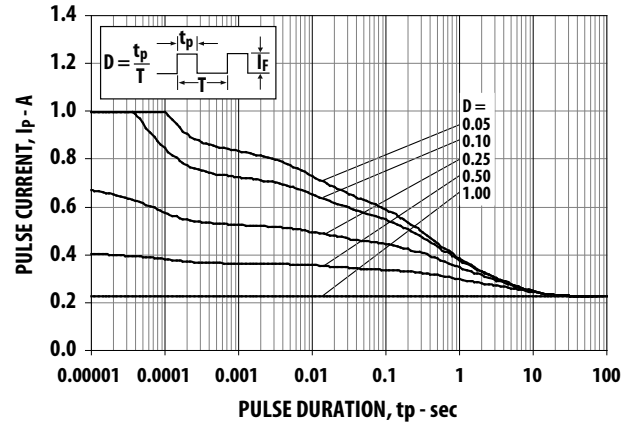

Figure 7. Maximum pulse current vs. pulse duration. Derated based on  $T_A = 85^\circ\text{C}$ ,  $R\theta_{J-A} = 50^\circ\text{C/W}$ .

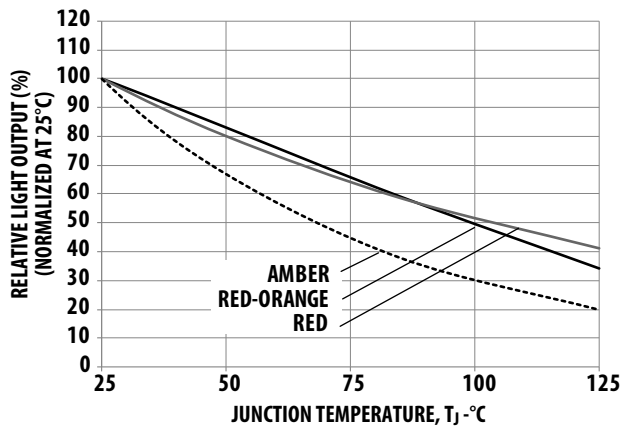

Figure 8. Relative Light Output vs. Junction Temperature.

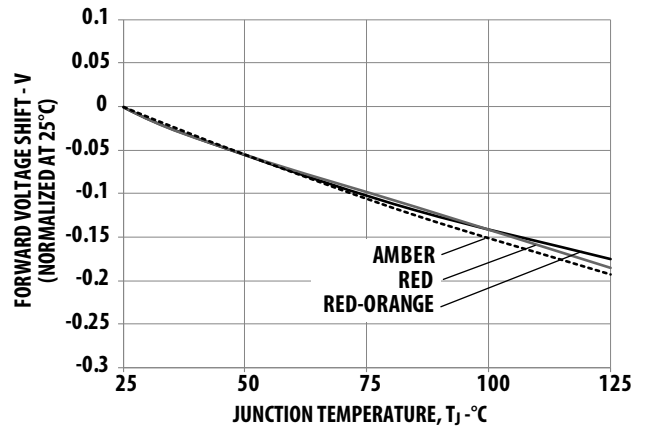

Figure 9. Forward Voltage Shift vs. Junction Temperature.

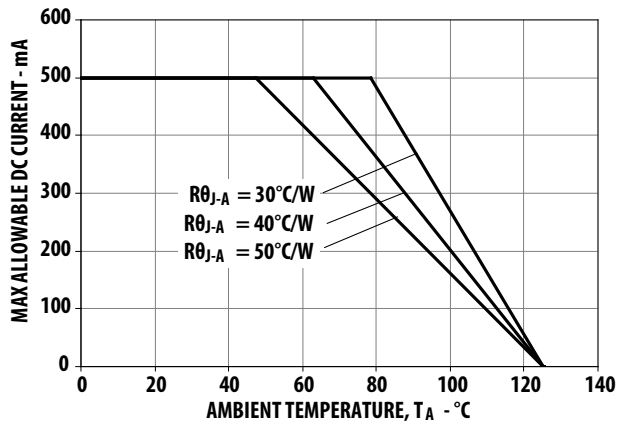

Figure 10. Maximum Forward Current vs. Ambient Temperature.  
Derated based on  $T_{JMAX} = 125^\circ\text{C}$ ,  $R\theta_{J-A} = 30^\circ\text{C/W}$ ,  $40^\circ\text{C/W}$  and  $50^\circ\text{C/W}$ .

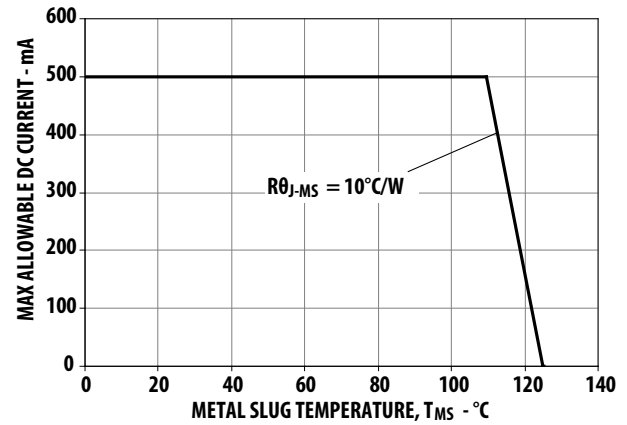

Figure 11. Maximum Forward Current vs. Metal Slug Temperature.  
Derated based on  $T_{JMAX} = 125^\circ\text{C}$ ,  $R\theta_{J-MS} = 10^\circ\text{C/W}$ .

# InGaN

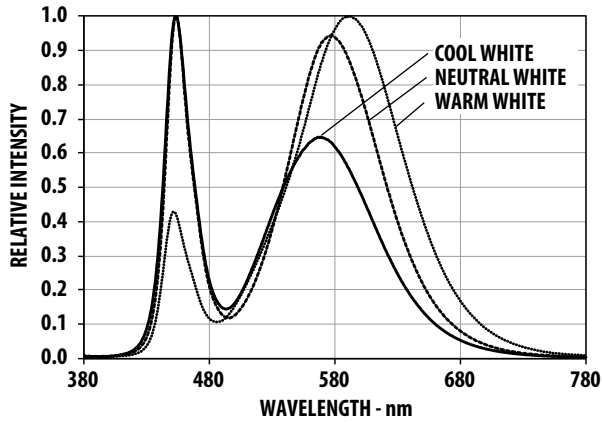

Figure 12. Relative Intensity vs. Wavelength for Cool and Warm White.

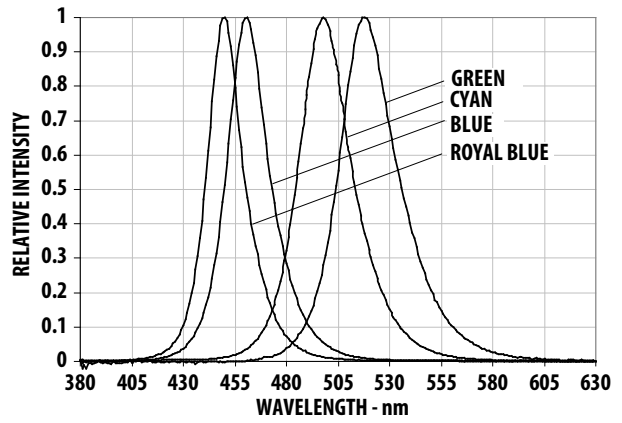

Figure 13. Relative Intensity vs. Wavelength for Blue, Royal Blue, Cyan and Green.

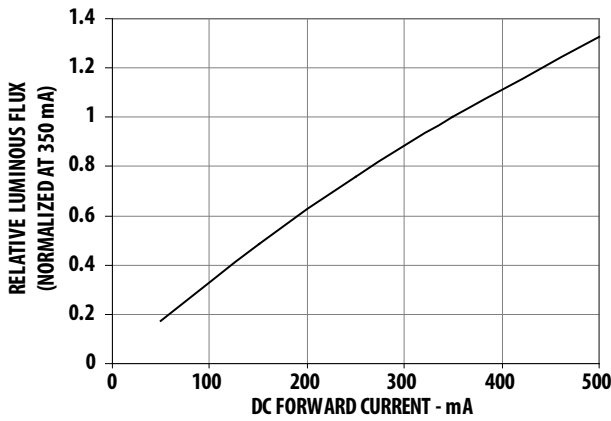

Figure 14. Relative Luminous Flux vs. Mono Pulse Current.

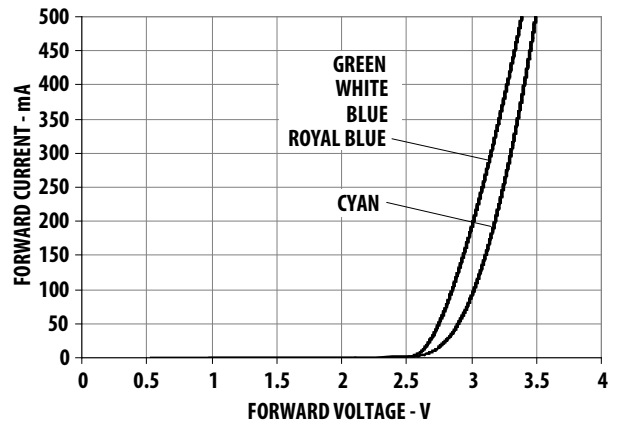

Figure 15. Forward Current vs. Forward Voltage.

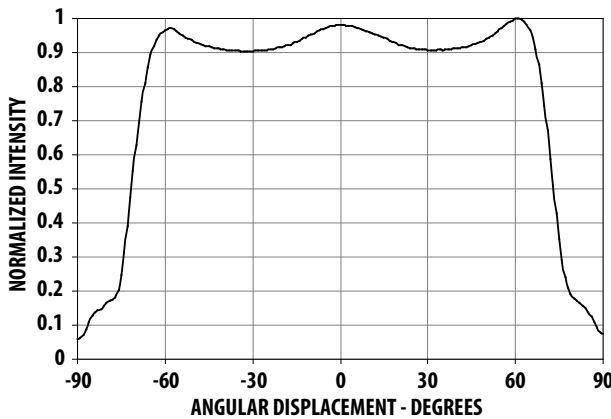

Figure 16. Radiation Pattern for Blue, Royal Blue, Cyan and Green.

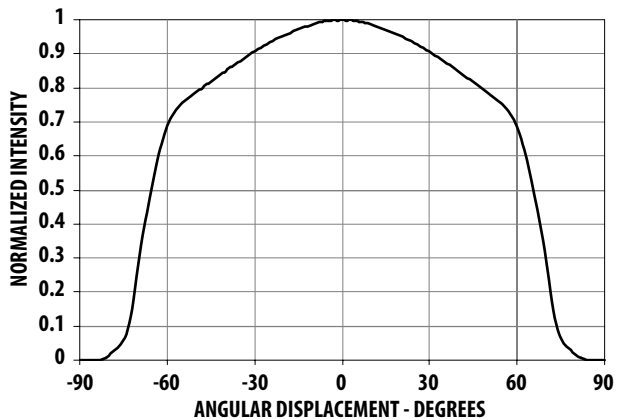

Figure 17. Radiation Pattern for Cool White, Neutral White and Warm White.

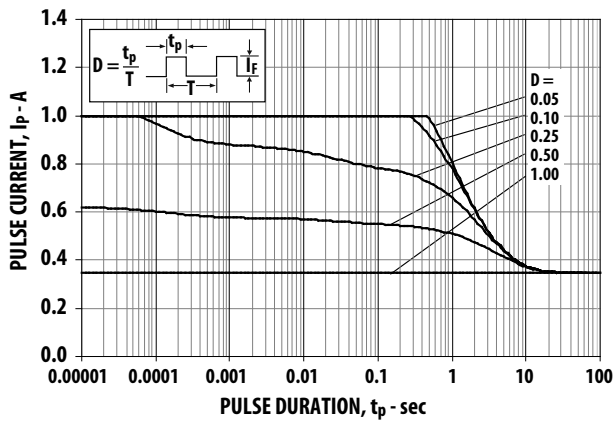

Figure 18. Maximum pulse current vs. pulse duration.  
Derated based on  $T_A = 25^\circ\text{C}$ ,  $R\theta_{J-A} = 50^\circ\text{C/W}$ .

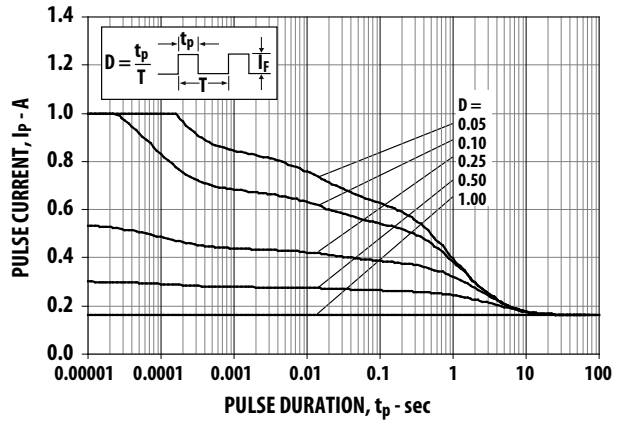

Figure 19. Maximum pulse current vs. pulse duration.  
Derated based on  $T_A = 85^\circ\text{C}$ ,  $R\theta_{J-A} = 50^\circ\text{C/W}$ .

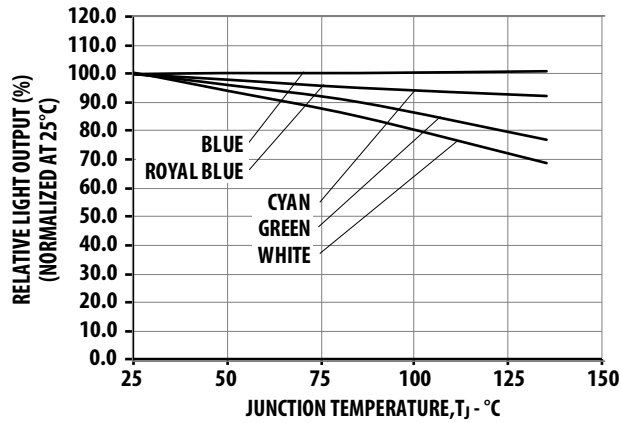

Figure 20. Relative Light Output vs. Junction Temperature.

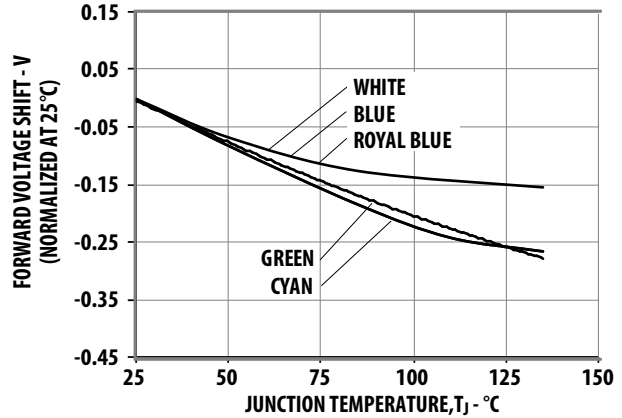

Figure 21. Forward Voltage Shift vs. Junction Temperature.

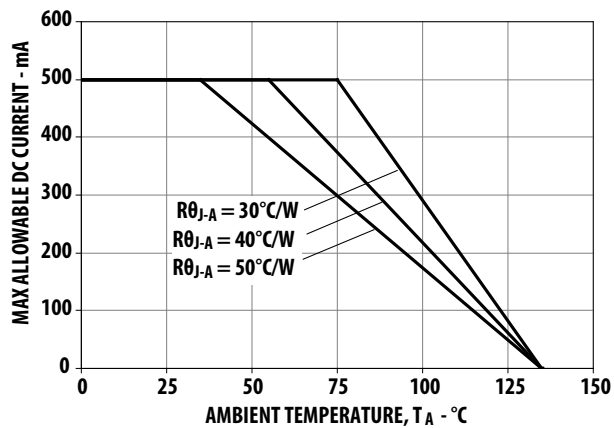

Figure 22. Maximum Forward Current vs. Ambient Temperature.  
Derated based on  $T_{JMAX} = 135^\circ\text{C}$ ,  $R\theta_{J-A} = 30^\circ\text{C/W}$ ,  $40^\circ\text{C/W}$  and  $50^\circ\text{C/W}$ .

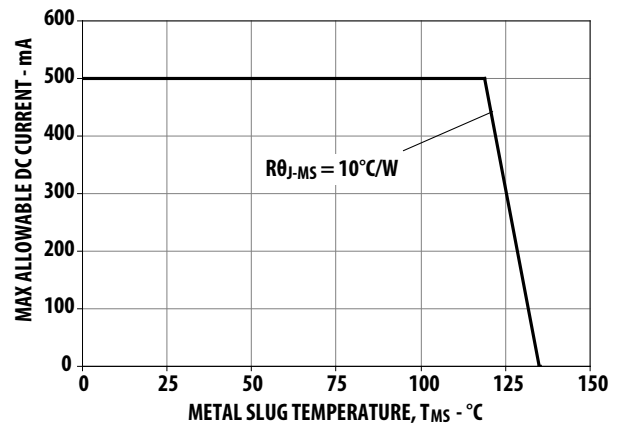

Figure 23. Maximum Forward Current vs. Metal Slug Temperature.  
Derated based on  $T_{JMAX} = 135^\circ\text{C}$ ,  $R\theta_{J-MS} = 10^\circ\text{C/W}$ .



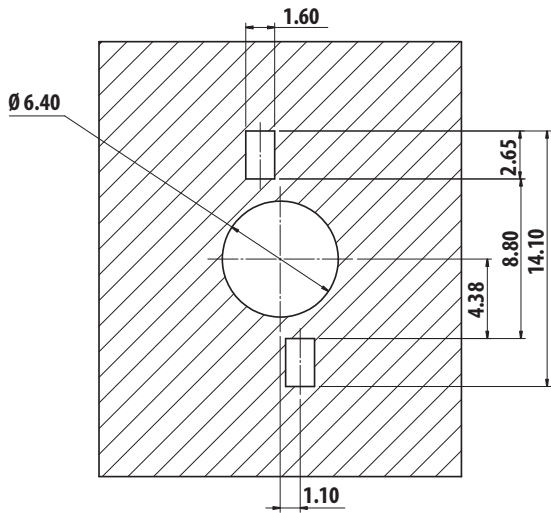

Figure 24. Recommended soldering land pattern

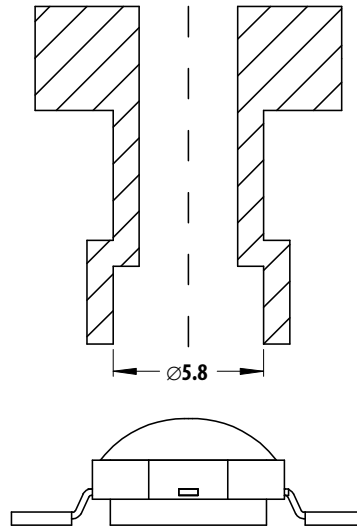

Figure 25. Recommended pick and place nozzle tip.  
Inner diameter = 5.8 mm.

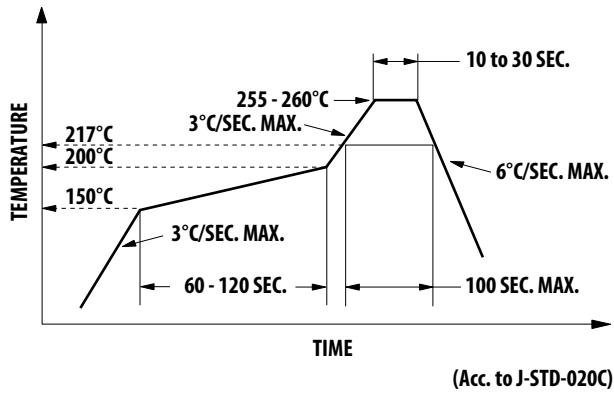

Figure 26. Recommended Reflow Soldering

Note:  
For detail information on reflow soldering of Avago surface mount LEDs, do refer to Avago Application Note AN1060 Surface Mounting SMT LED Indicator Components.

## Option Selection Details

### ASMT-Ax100 – x2 x3 x4 x5 x6

x3 – Minimum Flux Bin Selection

x4 – Maximum Flux Bin Selection

x5 – Color Bin Selection

x6 – Packaging Option

## Color Bin Selection [x5]

Individual reel will contain parts from one full bin only.

### Cool White

Selection	Bin ID
0	Full Distribution
E	VM, UM, VN and UN
F	WM, VM, WN and VN
G	XM, WM, XN and WN
H	UN, VN, U0 and V0
J	WN, VN, W0 and V0
K	XN, WN, X0 and W0
L	V0, U0, VP and UP
M	W0, V0, WP, VP and WQ
N	X0, W0, XP, WP and WQ
P	Y0
Q	YA

### Neutral White

Selection	Bin ID
0	Full Distribution
E	SM, RM, S1 and R1
F	TM, SM, TN and S1
G	S1, R1, S0 and R0
H	TN, S1, T0 and S0
J	S0, R0, SA and RA
K	T0, S0, TP and SA

## Flux / Power Bin Limit [x3, x4]

Color	Bin ID	Luminous Flux (lm) / Radiometric Power (mW) at 350 mA	
		Min.	Max.
Blue	K	8.2	10.7
	L	10.7	13.9
	M	13.9	18.1
	N	18.1	23.5
	P	23.5	30.6
Other Colors	Q	30.6	39.8
	R	39.8	51.7
	S	51.7	67.2
	T	67.2	87.4
	U	87.4	99.6
	V	99.6	113.6
Royal Blue	W	113.6	129.5
	M	225.0	275.0
	N	275.0	355.0
	P	355.0	435.0
	Q	435.0	515.0

Tolerance for each bin limits is  $\pm 10\%$

### Warm White

Selection	Bin ID
0	Full Distribution
E	NM, MM, N1 and M1
F	PM, NM, P1 and N1
G	QM, PM, Q1 and P1
H	M1, N1, M0 and N0
J	P1, N1, P0 and N0
K	Q1, P1, Q0 and P0
L	N0, M0, NA and MA
M	P0, N0, PA and NA
N	Q0, P0, QA and PA

### Other Colors

Selection	Bin ID
0	Full Distribution
Z	A and B
Y	B and C
W	C and D
V	D and E
U	E and F
Q	A, B and C
P	B, C and D
N	C, D and E
M	D, E and F

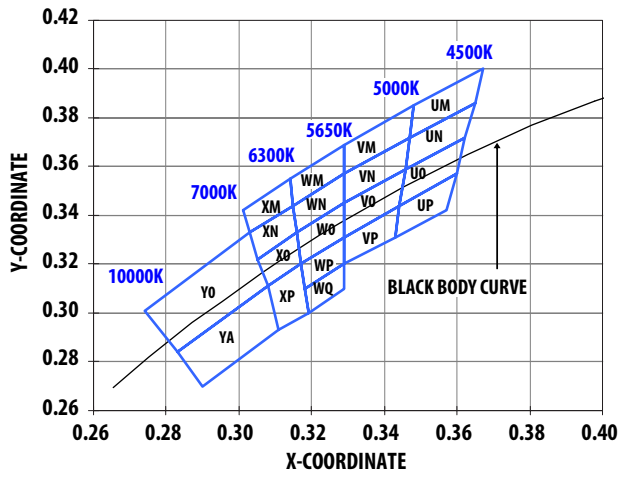

Figure 27. Color bin structure for Cool White.

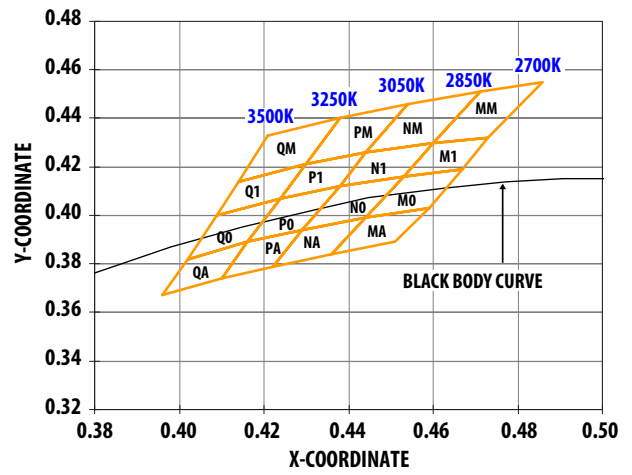

Figure 28. Color bin structure for Warm White.

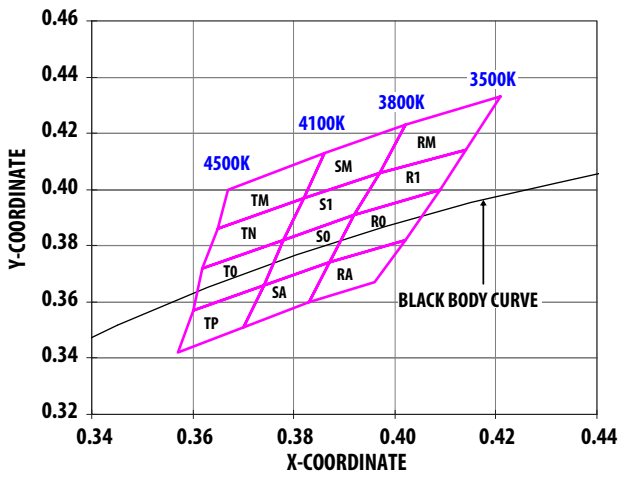

Figure 29. Color bin structure for Neutral White.

## Color Bin Limit

Cool White	Color Limits (Chromaticity Coordinates)				
Bin UM	X	0.365	0.367	0.348	0.347
	Y	0.385	0.400	0.385	0.372
Bin UN	X	0.365	0.362	0.346	0.347
	Y	0.386	0.372	0.359	0.372
Bin UO	X	0.362	0.360	0.344	0.346
	Y	0.372	0.357	0.344	0.359
Bin UP	X	0.360	0.357	0.343	0.344
	Y	0.357	0.342	0.311	0.344
Bin VM	X	0.329	0.329	0.348	0.347
	Y	0.357	0.369	0.385	0.372
Bin VN	X	0.329	0.329	0.347	0.346
	Y	0.345	0.357	0.372	0.359
Bin VO	X	0.329	0.329	0.346	0.344
	Y	0.331	0.345	0.359	0.344
Bin VP	X	0.329	0.344	0.343	0.329
	Y	0.331	0.344	0.331	0.320
Bin WM	X	0.329	0.329	0.315	0.314
	Y	0.369	0.357	0.344	0.355
Bin WN	X	0.329	0.316	0.315	0.329
	Y	0.345	0.333	0.344	0.357
Bin WO	X	0.329	0.329	0.317	0.316
	Y	0.345	0.331	0.320	0.333
Bin WP	X	0.329	0.329	0.318	0.317
	Y	0.331	0.320	0.310	0.320
Bin WQ	X	0.329	0.329	0.319	0.318
	Y	0.320	0.310	0.300	0.310
Bin XM	X	0.301	0.314	0.315	0.303
	Y	0.342	0.355	0.344	0.333
Bin XN	X	0.305	0.303	0.315	0.316
	Y	0.322	0.333	0.344	0.333
Bin XO	X	0.308	0.305	0.316	0.317
	Y	0.311	0.322	0.333	0.320
Bin XP	X	0.308	0.317	0.319	0.311
	Y	0.311	0.320	0.300	0.293
Bin YO	X	0.308	0.283	0.274	0.303
	Y	0.311	0.284	0.301	0.333
Bin YA	X	0.308	0.311	0.290	0.283
	Y	0.311	0.293	0.270	0.284

Tolerance:  $\pm 0.01$

Warm White	Color Limits (Chromaticity Coordinates)				
Bin MM	X	0.471	0.460	0.473	0.486
	Y	0.451	0.430	0.432	0.455
Bin M1	X	0.460	0.453	0.467	0.473
	Y	0.430	0.416	0.419	0.432
Bin M0	X	0.453	0.444	0.459	0.467
	Y	0.416	0.399	0.403	0.419
Bin MA	X	0.459	0.444	0.436	0.451
	Y	0.403	0.399	0.384	0.389
Bin NM	X	0.454	0.444	0.460	0.471
	Y	0.446	0.426	0.430	0.451
Bin N1	X	0.444	0.438	0.453	0.460
	Y	0.426	0.412	0.416	0.430
Bin N0	X	0.438	0.429	0.444	0.453
	Y	0.412	0.394	0.399	0.416
Bin NA	X	0.444	0.429	0.422	0.436
	Y	0.399	0.394	0.379	0.384
Bin PM	X	0.438	0.430	0.444	0.454
	Y	0.440	0.421	0.426	0.446
Bin P1	X	0.430	0.424	0.438	0.444
	Y	0.421	0.407	0.412	0.426
Bin P0	X	0.424	0.416	0.429	0.438
	Y	0.407	0.389	0.394	0.412
Bin PA	X	0.429	0.416	0.410	0.422
	Y	0.394	0.389	0.374	0.379
Bin QM	X	0.421	0.414	0.430	0.438
	Y	0.433	0.414	0.421	0.440
Bin Q1	X	0.414	0.409	0.424	0.430
	Y	0.414	0.400	0.407	0.421
Bin Q0	X	0.409	0.402	0.416	0.424
	Y	0.400	0.382	0.389	0.407
Bin QA	X	0.416	0.402	0.396	0.410
	Y	0.389	0.382	0.367	0.374

Tolerance:  $\pm 0.01$

Neutral White	Color Limits (Chromaticity Coordinates)				
Bin RM	X	0.421	0.414	0.397	0.402
	Y	0.433	0.414	0.406	0.423
Bin R1	X	0.414	0.409	0.392	0.397
	Y	0.414	0.400	0.391	0.406
Bin R0	X	0.392	0.387	0.402	0.409
	Y	0.391	0.374	0.382	0.400
Bin RA	X	0.387	0.383	0.396	0.402
	Y	0.374	0.360	0.367	0.382
Bin SM	X	0.402	0.397	0.382	0.386
	Y	0.423	0.406	0.397	0.413
Bin S1	X	0.397	0.392	0.378	0.382
	Y	0.406	0.391	0.382	0.397
Bin S0	X	0.392	0.387	0.374	0.378
	Y	0.391	0.374	0.366	0.382
Bin SA	X	0.387	0.383	0.370	0.374
	Y	0.374	0.360	0.351	0.366
Bin TM	X	0.386	0.382	0.365	0.367
	Y	0.413	0.397	0.386	0.400
Bin TN	X	0.382	0.378	0.362	0.365
	Y	0.397	0.382	0.372	0.386
Bin T0	X	0.378	0.374	0.360	0.362
	Y	0.382	0.366	0.357	0.372
Bin TP	X	0.374	0.370	0.357	0.360
	Y	0.366	0.351	0.342	0.357

Tolerance:  $\pm 0.01$

### Packaging Option [x<sub>6</sub>]

Selection	Option
0	Tube
1	Tape and Reel

### Example

#### ASMT-AW00-NST00

ASMT-AW00-Nxxxx – Cool White, InGaN, Electrically isolated Heat Sink

X<sub>3</sub> = S – Minimum Flux Bin S

X<sub>4</sub> = T – Maximum Flux Bin T

X<sub>5</sub> = 0 – Full Distribution

X<sub>6</sub> = 0 – Tube Option

Color	Bin ID	Dominant Wavelength (nm) at 350 mA		
		Min.	Max.	
Red	–	620.0	635.0	
Red Orange	–	610.0	620.0	
Amber	B	587.0	589.5	
	C	589.5	592.0	
	D	592.0	594.5	
	E	594.5	597.0	
Blue	A	455.0	460.0	
	B	460.0	465.0	
	C	465.0	470.0	
	D	470.0	475.0	
Cyan	C	490.0	495.0	
	D	495.0	500.0	
	E	500.0	505.0	
	F	505.0	510.0	
	G	510.0	515.0	
	H	515.0	520.0	
	Green	A	515.0	520.0
		B	520.0	525.0
C		525.0	530.0	
D		530.0	535.0	

Tolerance:  $\pm 1$  nm

Color	Bin ID	Peak Wavelength (nm) at 350 mA	
		Min.	Max.
Royal Blue	C	440.0	445.0
	D	445.0	450.0
	E	450.0	455.0
	F	455.0	460.0

Tolerance:  $\pm 2$  nm

## Packing Tube – Option 0

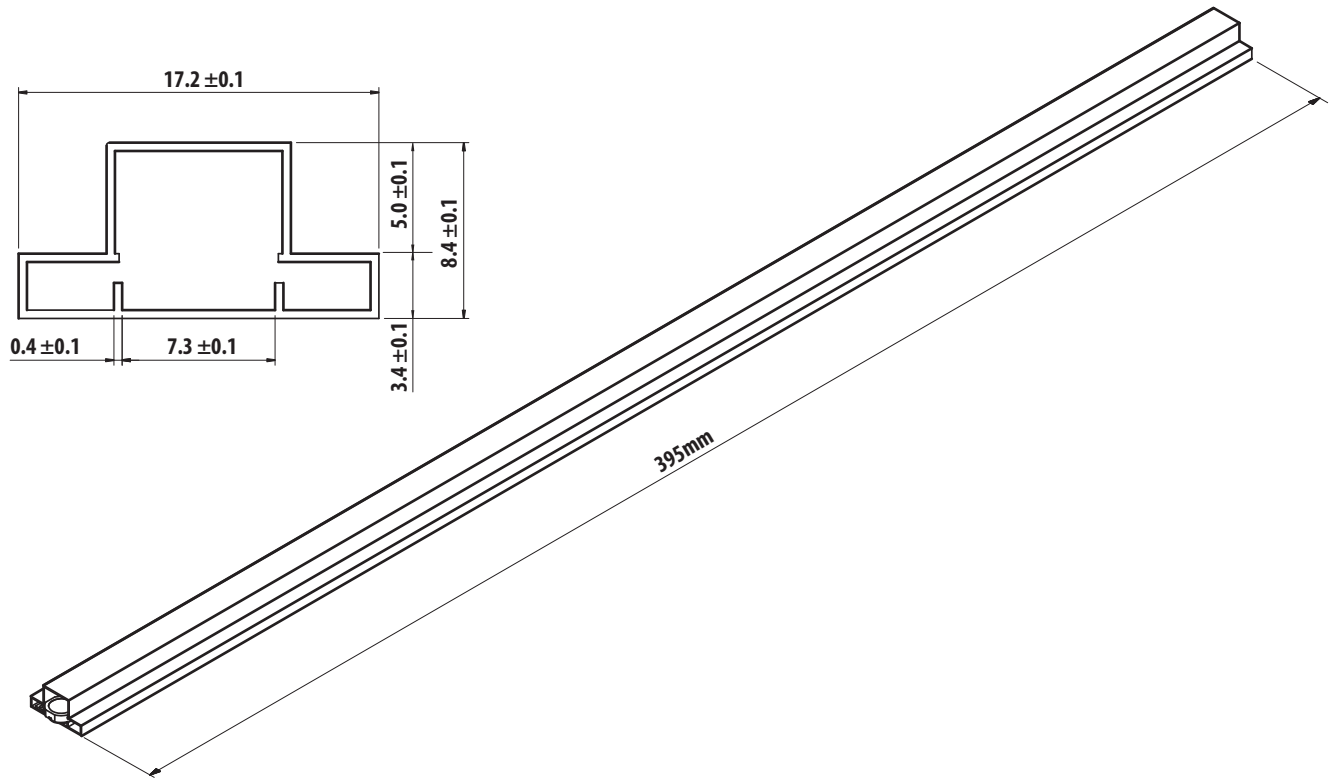

Figure 30. Package tube dimensions.

### Tape and Reel – Option 1

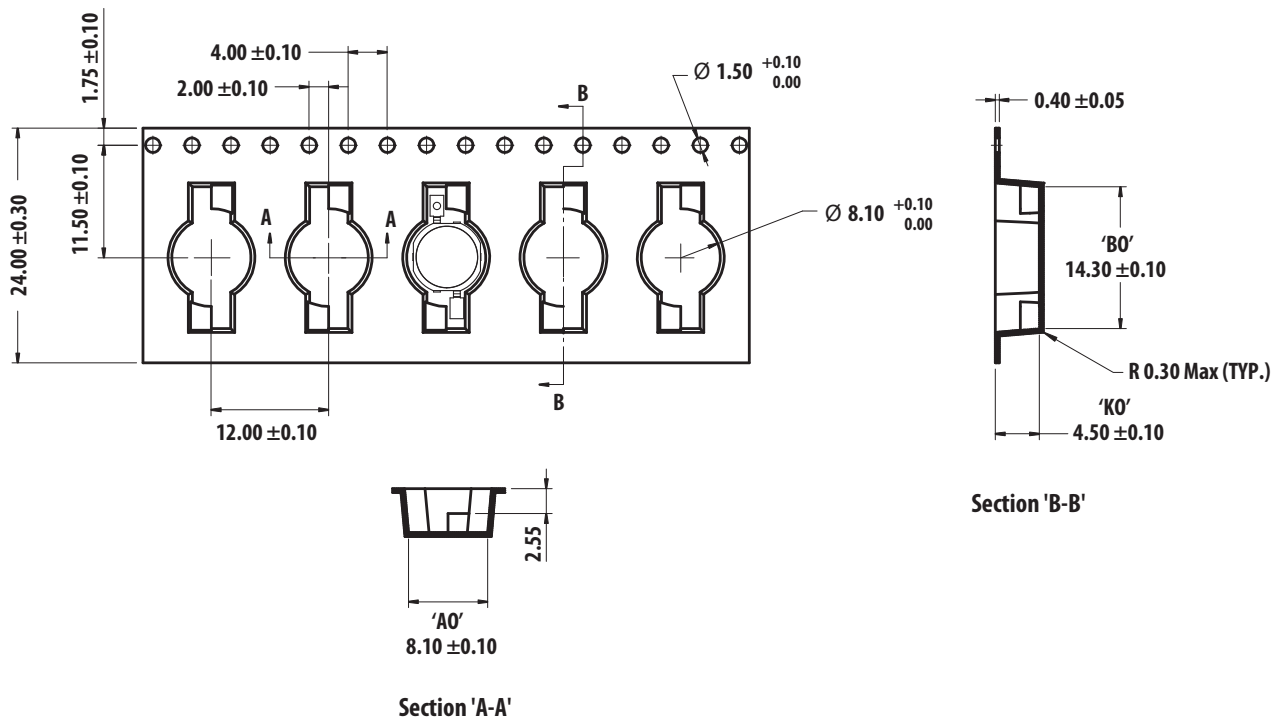

Figure 31. Carrier tape dimensions.

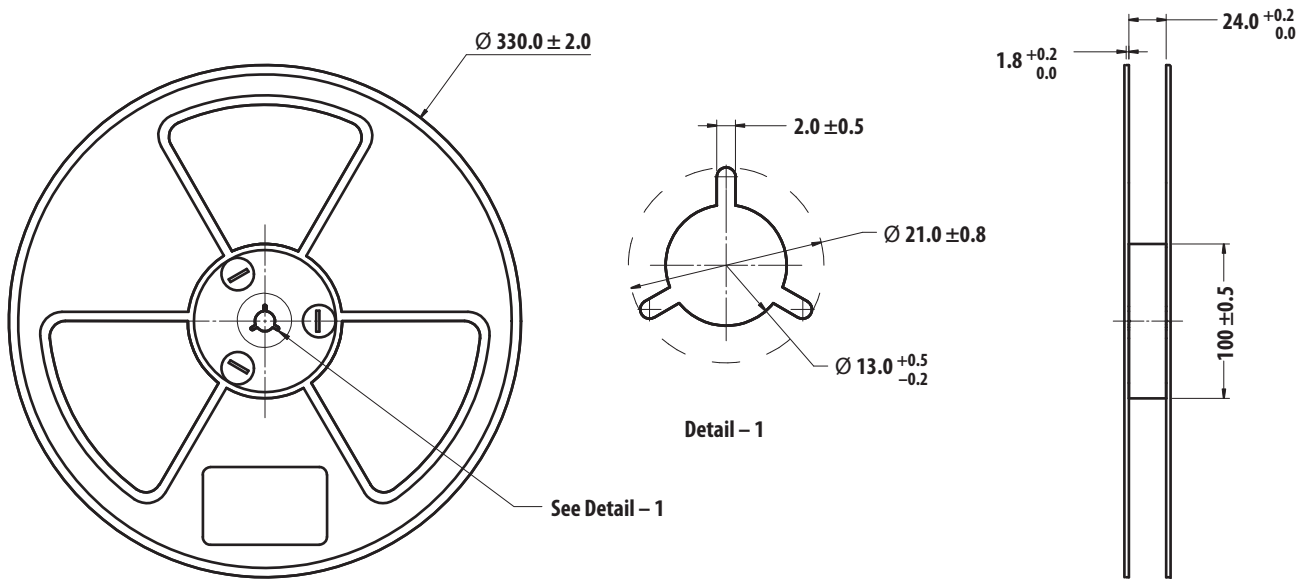

Figure 32. Reel dimensions.

## Handling Precaution

The encapsulation material of the product is made of silicone for better reliability of the product. As silicone is a soft material, please do not press on the silicone or poke a sharp object onto the silicone. These might damage the product and cause premature failure. During assembly of handling, the unit should be held on the body only. Please refer to Avago Application Note AN 5288 for detail information.

## Moisture Sensitivity

This product is qualified as Moisture Sensitive Level 2a per Jedec J-STD-020. Precautions when handling this moisture sensitive product is important to ensure the reliability of the product. Do refer to Avago Application Note AN5305 Handling of Moisture Sensitive Surface Mount Devices for details.

### A. Storage before use

- Unopen moisture barrier bag (MBB) can be stored at <math>40^{\circ}\text{C}/90\%RH</math> for 12 months. If the actual shelf life has exceeded 12 months and the humidity indicator card (HIC) indicates that baking is not required, then it is safe to reflow the LEDs per the original MSL rating.
- It is not recommended to open the MBB prior to assembly (e.g. for IQC).

### B. Control after opening the MBB

- The humidity indicator card (HIC) shall be read immediately upon opening of MBB.
- The LEDs must be kept at <math>30^{\circ}\text{C}/60\%RH</math> at all time and all high temperature related process including soldering, curing or rework need to be completed within 672 hours.

### C. Control for unfinished reel

- For any unused LEDs, they need to be stored in sealed MBB with desiccant or desiccator at <math>5\%RH</math>.

### D. Control of assembled boards

- If the PCB soldered with the LEDs is to be subjected to other high temperature processes, the PCB need to be stored in sealed MBB with desiccant or desiccator at <math>5\%RH</math> to ensure no LEDs have exceeded their floor life of 672 hours.

### E. Baking is required if:

- HIC "10%" indicator is NOT Brown and "5%" indicator is Azure.
- The LEDs are exposed to condition of <math>30^{\circ}\text{C}/60\%RH</math> at any time.
- The LED floor life exceeded 672hrs.

Recommended baking condition:  $60\pm 5^{\circ}\text{C}$  for 20hrs.

**DISCLAIMER:** Avago's products and software are not specifically designed, manufactured or authorized for sale as parts, components or assemblies for the planning, construction, maintenance or direct operation of a nuclear facility or for use in medical devices or applications. Customer is solely responsible, and waives all rights to make claims against avago or its suppliers, for all loss, damage, expense or liability in connection with such use.

For product information and a complete list of distributors, please go to our web site: [www.avagotech.com](http://www.avagotech.com)

Avago, Avago Technologies, and the A logo are trademarks of Avago Technologies in the United States and other countries. Data subject to change. Copyright © 2005-2014 Avago Technologies. All rights reserved. AV02-1640EN - February 11, 2014

**AVAGO**  
TECHNOLOGIES