

Direct connector - SDC 2,5/13-PV-5,0-ZB - 1864147

Please be informed that the data shown in this PDF Document is generated from our Online Catalog. Please find the complete data in the user's documentation. Our General Terms of Use for Downloads are valid (<http://phoenixcontact.com/download>)

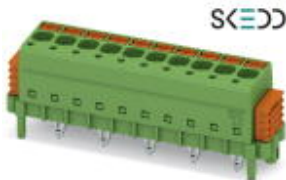

PCB direct plug, nominal current: 12 A, rated voltage (III/2): 320 V, nominal cross section: 2.5 mm², number of positions: 13, pitch: 5 mm, connection method: Push-in spring connection, color: green, contact surface: Tin, mounting: SKEDD - Direct plug-in technology, pin layout: Zigzag pinning W, solder pin [P]: 4.7 mm

The figure shows a 10-position version

Your advantages

- ✓ SKEDD direct plug-in technology enables flexible positioning on the PCB
- ✓ Reduced component and process costs: simple insertion by hand and vibration-resistant connection
- ✓ Wide range of applications, thanks to suitability for PCBs with chemically tin-plated or Hot Air Leveling (HAL) surface
- ✓ Time saving push-in connection, tools not required
- ✓ Intuitive use through colour coded actuation lever
- ✓ Quick and convenient testing using integrated test option

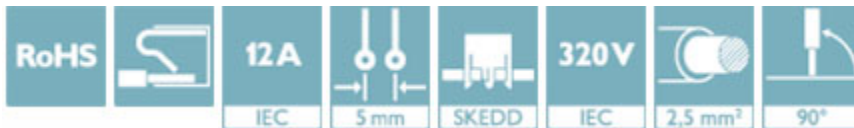

Key Commercial Data

Packing unit	1 pc
Minimum order quantity	50 pc
GTIN	
GTIN	4055626210544
Weight per Piece (excluding packing)	16.400 g
Custom tariff number	85366990
Country of origin	Poland

Technical data

Item properties

Brief article description	Direct connector
Range of articles	SDC 2,5/..-PV

Direct connector - SDC 2,5/13-PV-5,0-ZB - 1864147

Technical data

Item properties

Pitch	5 mm
Number of positions	13
Connection method	Push-in spring connection
Mounting type	SKEDD - Direct plug-in technology
Pin layout	Zigzag pinning W
Number of levels	1
Number of connections	13
Number of potentials	13

Electrical parameters

Nom. voltage	320 V
--------------	-------

Connection capacity

Connection method	Push-in spring connection
pluggable	Yes
Conductor cross section solid	0.2 mm ² ... 2.5 mm ²
Conductor cross section flexible	0.2 mm ² ... 2.5 mm ²
Conductor cross section AWG / kcmil	24 ... 12
Conductor cross section flexible, with ferrule without plastic sleeve	0.25 mm ² ... 2.5 mm ²
Conductor cross section, flexible, with ferrule, with plastic sleeve	0.25 mm ² ... 2.5 mm ²
Stripping length	10 mm

Specifications for ferrules

Recommended crimping pliers	1212045 CRIMPFOX 10S	
Ferrules without insulating collar, according to DIN 46228-1	Cross section: 0.25 mm ² ; Length: 7 mm	
	Cross section: 0.34 mm ² ; Length: 7 mm	
	Cross section: 0.5 mm ² ; Length: 8 mm ... 10 mm	
	Cross section: 0.75 mm ² ; Length: 10 mm	
	Cross section: 1 mm ² ; Length: 10 mm	
Recommended crimping pliers	1212045 CRIMPFOX 10S	
	Ferrules with insulating collar, according to DIN 46228-4	Cross section: 0.25 mm ² ; Length: 8 mm
		Cross section: 0.34 mm ² ; Length: 8 mm ... 10 mm
		Cross section: 0.5 mm ² ; Length: 8 mm ... 10 mm
		Cross section: 0.75 mm ² ; Length: 8 mm ... 10 mm
Cross section: 1 mm ² ; Length: 8 mm ... 10 mm		
	Cross section: 1.5 mm ² ; Length: 8 mm ... 10 mm	
	Cross section: 2.5 mm ² ; Length: 10 mm	

Direct connector - SDC 2,5/13-PV-5,0-ZB - 1864147

Technical data

Material data - contact

Note	WEEE/RoHS-compliant, free of whiskers according to IEC 60068-2-82/ JEDEC JESD 201
Contact material	Cu alloy
Surface characteristics	Tin-plated
Metal surface terminal point (top layer)	Tin (4 - 8 µm Sn)
Metal surface terminal point (middle layer)	Nickel (1.5 - 4 µm Ni)
Metal surface soldering area (top layer)	Tin (4 - 8 µm Sn)
Metal surface soldering area (middle layer)	Nickel (1.5 - 4 µm Ni)

Material data - housing

Insulating material	PA
Insulating material group	I
CTI according to IEC 60112	600
Flammability rating according to UL 94	V0

Material data – actuating element

Insulating material	PBT
CTI according to IEC 60112	275
Flammability rating according to UL 94	V0

Dimensions for the product

Length [l]	15.3 mm
Width [w]	73.18 mm
Height [h]	21.2 mm
Pitch	5 mm
Height (without solder pin)	16.2 mm
Solder pin [P]	4.7 mm
Pin spacing	10.00 mm
Dimension a	60 mm

Packaging information

Type of packaging	packed in cardboard
Pieces per package	50
Denomination packing units	Pcs.

Ambient conditions

Ambient temperature (storage/transport)	-40 °C ... 70 °C
Ambient temperature (assembly)	-5 °C ... 100 °C
Ambient temperature (operation)	-40 °C ... 100 °C (dependent on the derating curve)

Termination and connection method

Direct connector - SDC 2,5/13-PV-5,0-ZB - 1864147

Technical data

Termination and connection method

Conductor connection test	The stripped-off ends of the largest conductor can be completely inserted in the opening of the terminal point without using excessive force.
Test result	Test passed
Test – repeated connection and release	IEC 60999-1:1999-11
	Test passed
Test for conductor damage and slackening	IEC 60999-1:1999-11
	Test passed

Pull-out test

Pull-out test	IEC 60999-1:1999-11
	Test passed
Conductor cross section / conductor type / tensile force	0.2 mm ² / solid / > 10 N
	0.2 mm ² / flexible / > 10 N
	2.5 mm ² / solid / > 50 N
	2.5 mm ² / flexible / > 50 N

Mechanical tests according to standard

Visual examination	Test passed IEC 60512-1-1:2002-02
Dimensional test	Test passed IEC 60512-1-2:2002-02
Resistance of marking	Test passed IEC 60068-2-70:1995-12
Result	Test passed
Specification	IEC 60512-13-2:2006-02
No. of cycles	25
Insertion strength per pos. approx.	8 N
Withdraw strength per pos. approx.	6 N
Polarization and coding	Test passed IEC 60512-13-5:2006-02
Result	Test passed
Specification	IEC 60512-15-1:2008-05
Test force per pos.	20 N

Air clearances and creepage distances

Clearances and creepage distances	IEC 60664-1:2007-04
Specification	IEC 60664-1:2007-04
Rated insulation voltage (III/3)	200 V
Rated insulation voltage (III/2)	320 V
Rated insulation voltage (II/2)	320 V
Rated surge voltage (III/3)	4 kV
Rated surge voltage (III/2)	4 kV
Rated surge voltage (II/2)	4 kV

Direct connector - SDC 2,5/13-PV-5,0-ZB - 1864147

Technical data

Air clearances and creepage distances

Minimum clearance - inhomogeneous field (III/3)	3 mm
Minimum clearance - inhomogeneous field (III/2)	3 mm
Minimum clearance - inhomogeneous field (II/2)	3 mm
Minimum creepage distance value (III/3)	3.2 mm
Minimum creepage distance value (III/2)	3.2 mm
Minimum creepage distance value (II/2)	3.2 mm

Electrical tests - Function

Specification	IEC 60999-1:1999-11
---------------	---------------------

Temperature cycles

Specification	IEC 60999-1:1999-11
Test current (minimum cross section)	4 A DC
Test current (maximum cross section)	12 A DC
Temperature cycles	192

Mechanical tests (A)

Insertion strength per pos. approx.	8 N
Withdraw strength per pos. approx.	6 N
Polarization when inserted requirement >20 N	Test passed
Contact holder in insert requirements >20 N	Test passed

Durability tests (B)

Specification	IEC 60512-9-1:2010-03
Contact resistance R_1	1.1 m Ω
Insertion/withdrawal cycles	25
Contact resistance R_2	1.1 m Ω
Impulse withstand voltage at sea level	4.8 kV
Power-frequency withstand voltage	2.21 kV
Insulation resistance, neighboring positions	> 1 T Ω

Climatic tests (D)

Specification	ISO 6988:1985-02
Cold stress	-40 °C/2 h
Thermal stress	100 °C/168 h
Corrosive stress	0.2 dm ³ SO ₂ on 300 dm ³ /40 °C/1 cycle
Impulse withstand voltage at sea level	4.8 kV
Power-frequency withstand voltage	2.21 kV

Environmental and durability tests (E)

Direct connector - SDC 2,5/13-PV-5,0-ZB - 1864147

Technical data

Environmental and durability tests (E)

Specification	IEC 61984:2008-10
Result, degree of protection, IP code	Finger safety with IP20 test finger

Standards and Regulations

Connection in acc. with standard	EN-VDE
----------------------------------	--------

Environmental Product Compliance

China RoHS	Environmentally friendly use period: unlimited = EFUP-e
	No hazardous substances above threshold values

Drawings

Drilling diagram

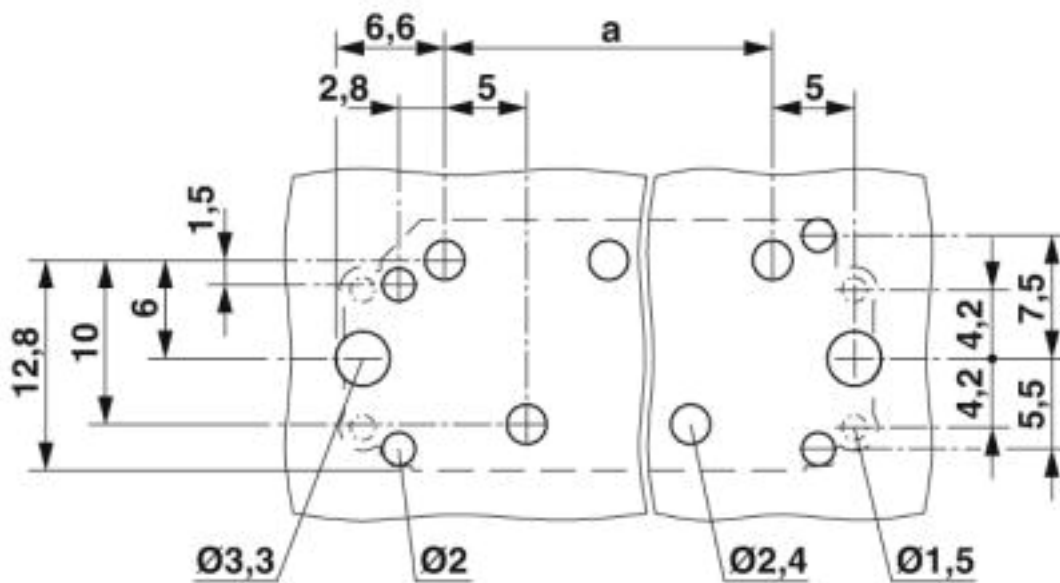

Size of the PCB: 1.6 mm

Direct connector - SDC 2,5/13-PV-5,0-ZB - 1864147

Diagram

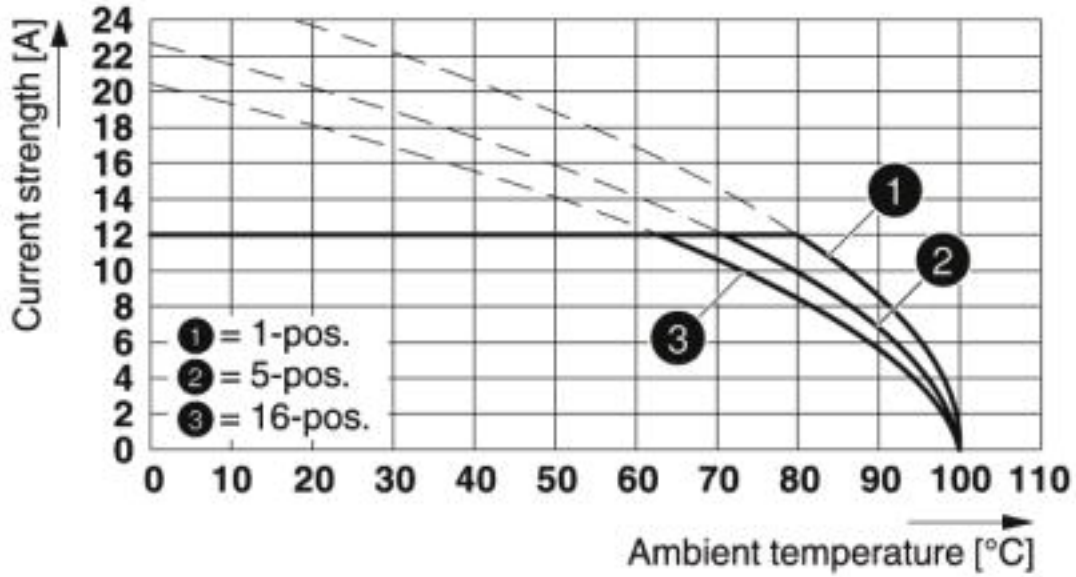

Type: SDC 2,5/...-PV-5,0-ZB

Dimensional drawing

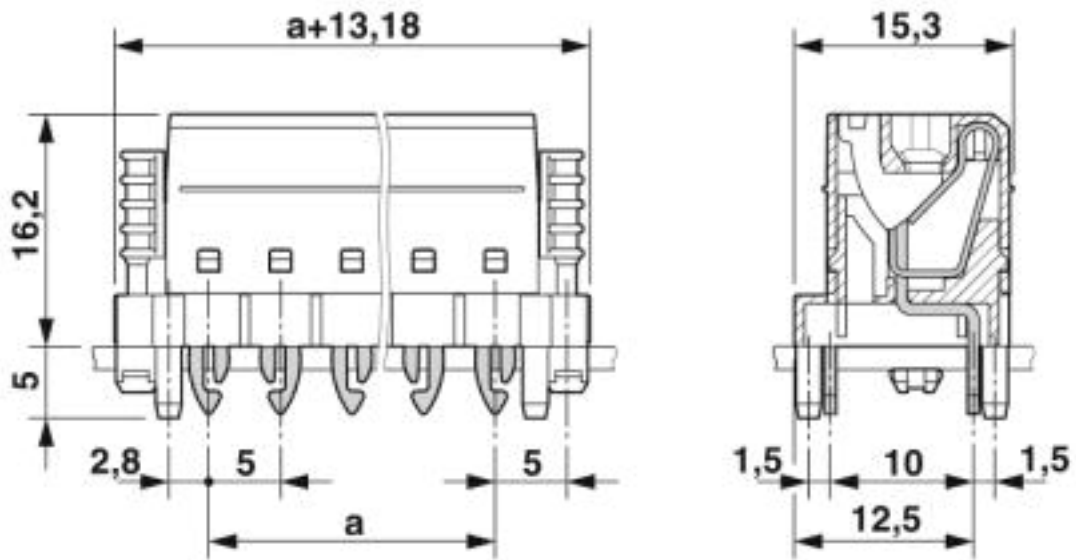

Classifications

eCl@ss

eCl@ss 4.0	27260700
------------	----------

Direct connector - SDC 2,5/13-PV-5,0-ZB - 1864147

Classifications

eCl@ss

eCl@ss 4.1	27260700
eCl@ss 5.0	27260700
eCl@ss 5.1	27260700
eCl@ss 6.0	27260700
eCl@ss 7.0	27440309
eCl@ss 8.0	27440309
eCl@ss 9.0	27440309

ETIM

ETIM 5.0	EC002637
ETIM 6.0	EC002638
ETIM 7.0	EC002638

UNSPSC

UNSPSC 13.2	39121432
UNSPSC 18.0	39121409
UNSPSC 19.0	39121409
UNSPSC 20.0	39121409
UNSPSC 21.0	39121409

Approvals

Approvals

Approvals

IECEE CB Scheme / VDE Zeichengenehmigung / cULus Recognized

Ex Approvals

Approval details

IECEE CB Scheme		http://www.iecee.org/	DE1-59474
-----------------	---	---	-----------

Direct connector - SDC 2,5/13-PV-5,0-ZB - 1864147

Approvals

VDE Zeichengenehmigung		http://www2.vde.com/de/Institut/Online-Service/VDE-gepruefteProdukte/Seiten/Online-Suche.aspx	40044617
Nominal voltage UN	320 V		
Nominal current IN	12 A		
mm ² /AWG/kcmil	0.2-2.5		

cULus Recognized		http://database.ul.com/cgi-bin/XYV/template/LISEXT/1FRAME/index.htm	E60425-20160718
	B	D	
Nominal voltage UN	300 V	300 V	
Nominal current IN	12 A	10 A	
mm ² /AWG/kcmil	24-12	24-12	

Accessories

Accessories

Cable end sleeve

Ferrule - AI 0,5 -10 WH - 3201275



Ferrule, sleeve length: 10 mm, length: 16 mm, color: white

Ferrule - AI 0,75-10 GY - 3201288



Ferrule, sleeve length: 10 mm, length: 16 mm, color: gray

Direct connector - SDC 2,5/13-PV-5,0-ZB - 1864147

Accessories

Ferrule - AI 1 -10 RD - 3200182



Ferrule, sleeve length: 10 mm, length: 16 mm, color: red

Ferrule - AI 1,5 -10 BK - 3200195



Ferrule, sleeve length: 10 mm, length: 16 mm, color: black

Ferrule - AI 2,5 -10 BU - 3202533



Ferrule, sleeve length: 10 mm, length: 17 mm, color: blue

Ferrule - A 0,5 -10 - 3202494



Ferrule, length: 10 mm, color: silver

Ferrule - A 0,75-10 - 3200234



Ferrule, length: 10 mm, color: silver

Direct connector - SDC 2,5/13-PV-5,0-ZB - 1864147

Accessories

Ferrule - A 1 -10 - 3200250



Ferrule, length: 10 mm, color: silver

Ferrule - A 1,5 -10 - 3200276



Ferrule, length: 10 mm, color: silver

Coding element

Coding profile - CP-PT 1,5 - 1985564



Coding profile, inserted into the hole on the plug, made from red insulating material, diameter: 1.35 mm

Crimping tool

Crimping pliers - CRIMPFOX 6 - 1212034



Crimping pliers, for ferrules without insulating collar according to DIN 46228 Part 1 and ferrules with insulating collar according to DIN 46228 Part 4, 0.25 mm² ... 6.0 mm², lateral entry, trapezoidal crimp

Labeled terminal marker

Direct connector - SDC 2,5/13-PV-5,0-ZB - 1864147

Accessories

Marker card - SK 5/3,8:FORTL.ZAHLEN - 0804183



Marker card, Card, white, labeled, Horizontal: consecutive numbers 1 ... 10, 11 ... 20, etc. up to 91 ... (99)100, mounting type: adhesive, for terminal block width: 5 mm, lettering field size: 5 x 3.8 mm

Marker card - SK 3,8 REEL P5 WH CUS - 0825124



Marker card, Card, can be ordered: By card, white, labeled according to customer specifications, mounting type: adhesive, for terminal block width: 5 mm, lettering field size: continuous x 3.8 mm

Terminal marking

Marker card - SK U/3,8 WH:UNBEDRUCKT - 0803906



Marker card, Sheet, white, unlabeled, can be labeled with: PLOTMARK, CMS-P1-PLOTTER, Office printing systems, mounting type: adhesive, for terminal block width: 210 mm, lettering field size: 186 x 3.8 mm, Number of individual labels: 1440

Marker strip - SK 3,8 WH:REEL - 0805218



Marker strip, Roll, white, unlabeled, can be labeled with: THERMOMARK ROLL 2.0, THERMOMARK ROLL, THERMOMARK ROLL X1, THERMOMARK ROLLMASTER 300/600, THERMOMARK X1.2, mounting type: adhesive, for terminal block width: 90000 mm, lettering field size: continuous x 3.8 mm, Number of individual labels: 210000

Test plug terminal block

Test plugs - MPS-MT 1-S - 1944372



Test plug, consisting of 1.0 mm Ø test pin and 2.0 mm Ø socket

Direct connector - SDC 2,5/13-PV-5,0-ZB - 1864147

Accessories

Phoenix Contact 2020 © - all rights reserved
<http://www.phoenixcontact.com>