

Features

- Low THD, 10% Max up to 240 Vac
- Compact Metal Case with Excellent Thermal Performance
- Isolated 0-10V Dimmable
- Input Surge Protection: 4kV line-line, 6kV line-earth
- High Reliability & Long Lifetime: 93,000 hrs. at 75°C Case Temperature
- Suitable for Built-in Use and Class I Luminaires
- Input UVP and Input OVP
- Waterproof(IP66) and UL Dry / Damp Location
- Class 2 & SELV Output
- TYPE HL, for Use in a Class I, Division 2 Hazardous (Classified) Location
- 5 Years Warranty

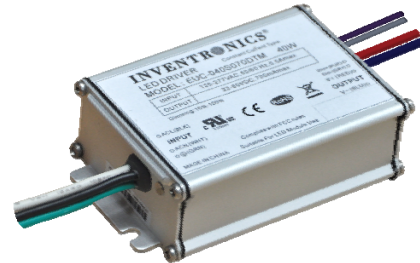

Description

The EUC-040SxxxDTM000x series is a 40W, constant-current IP66 LED driver that operates from 90-305 Vac input with excellent power factor and THD feature. It is created for low bay, tunnel and street lights. The high efficiency of these drivers and compact metal case enable them to run cooler, significantly improving reliability and extending product life. To ensure trouble-free operation, protection is provided against input surge, input under voltage, input over voltage, output over voltage, short circuit, and over temperature.

Models

Output Current	Input Voltage Range(1)	Output Voltage Range	Max. Output Power	Typical Efficiency (2)	Power Factor		Model Number(3)
					120Vac	220Vac	
500 mA	90 ~ 305 Vac 127 ~ 300 Vdc	40 ~ 80 Vdc	40 W	87%	0.99	0.96	EUC-040S070DTM0004
700 mA	90 ~ 305 Vac 127 ~ 300 Vdc	32 ~ 57 Vdc	40 W	86%	0.99	0.96	EUC-040S070DTM
860 mA	90 ~ 305 Vac 127 ~ 300 Vdc	23 ~ 45 Vdc	39 W	86%	0.99	0.96	EUC-040S110DTM0005 ⁽⁴⁾
1050 mA	90 ~ 305 Vac 127 ~ 300 Vdc	21 ~ 38 Vdc	40 W	85%	0.99	0.96	EUC-040S110DTM0001 ⁽⁴⁾

Notes: (1) UL, FCC certified input voltage range: 120-277Vac/127-300Vdc; other certified input voltage range except UL & FCC: 120-240Vac/127-250Vdc.

(2) Measured at full load and 220 Vac input.

(3) SELV output.

(4) Class 2 output.

Input Specifications

Parameter	Min.	Typ.	Max.	Notes
Input Voltage	90 Vac	-	305 Vac	127 ~ 300 Vdc

Input Specifications (Continued)

Parameter	Min.	Typ.	Max.	Notes
Input Frequency	47 Hz	-	63 Hz	
Leakage Current	-	-	0.75 MIU	UL8750; 277Vac/ 60Hz
	-	-	0.70 mA	IEC60598-1; 240Vac/ 60Hz
Input AC Current	-	-	0.55 A	Measured at full load and 120 Vac input.
	-	-	0.30 A	Measured at full load and 220 Vac input.
Inrush Current(I ² t)	-	-	0.01 A ² s	At 220Vac input, 25°C cold start, duration= 36 μS, 10%Ipk-10%Ipk. See Inrush Current Waveform for the details.
Power Factor	0.90	-	-	120-277Vac, 50~60Hz, 75%-100%Load (30~40W)
THD	-	-	15%	
THD	-	-	10%	200-240Vac, 50~60Hz, 75%-100%Load (30~40W)

Output Specifications

Parameter	Min.	Typ.	Max.	Notes
Output Current Tolerance	-8%lo	-	8%lo	At full load condition
Total Output Current Ripple (pk-avg)	-	50%lo	75%lo	At full load condition
Startup Overshoot Current	-	5%lo	10%lo	At full load condition
No Load Output Voltage	-	-	100V	
EUC-040S070DTM0004	-	-	100V	
EUC-040S070DTM	-	-	60V	
EUC-040S110DTM0005	-	-	60V	
Line Regulation	-	-	±5.0%	Measured at full load
Load Regulation	-	-	±5.0%	
Turn-on Delay Time	-	1.5 s	2.0 s	Measured at 120Vac input, 75%-100%Load
	-	1.0 s	1.5 s	Measured at 220Vac input, 75%-100%Load
Temperature Coefficient of Iomax	-	0.06%/°C	-	Case temperature = 0°C~Tc max

Note: All specifications are tested by Cree XLamp XP-G and typical measured at 220Vac and 25°C unless otherwise stated.

General Specifications

Parameter	Min.	Typ.	Max.	Notes
Efficiency at 120 Vac input: EUC-040S070DTM0004 EUC-040S070DTM EUC-040S110DTM0005 EUC-040S110DTM0001	84.0% 83.0% 83.0% 82.0%	85.0% 84.0% 84.0% 83.0%	- - - -	Measured at full load and steady-state temperature in 25°C ambient; (Efficiency will be about 1.0% lower if measured immediately after startup.)
Efficiency at 220 Vac input: EUC-040S070DTM0004 EUC-040S070DTM EUC-040S110DTM0005 EUC-040S110DTM0001	86.0% 85.0% 85.0% 84.0%	87.0% 86.0% 86.0% 85.0%	- - - -	Measured at full load and steady-state temperature in 25°C ambient; (Efficiency will be about 1.0% lower if measured immediately after startup.)
Efficiency at 277 Vac input: EUC-040S070DTM0004 EUC-040S070DTM EUC-040S110DTM0005 EUC-040S110DTM0001	86.0% 85.0% 85.0% 84.0%	87.0% 86.0% 86.0% 85.0%	- - - -	Measured at full load and steady-state temperature in 25°C ambient; (Efficiency will be about 1.0% lower if measured immediately after startup.)
MTBF	-	546,000 Hours	-	Measured at 220Vac input, 80%Load and 25°C ambient temperature (MIL-HDBK-217F)
Lifetime	-	93,000 Hours	-	Measured at 120Vac input, 80%Load and 75°C case temperature; See lifetime vs. Tc curve for the details
Operating Case Temperature for Safety Tc_s	-40 °C	-	+90 °C	
Operating Case Temperature for Warranty Tc_w	-40 °C	-	+75 °C	Case temperature for 5 years warranty. Humidity: 10% RH to 100% RH.
Storage Temperature	-40 °C	-	+85 °C	Humidity: 5% RH to 100% RH
Dimensions Inches (L × W × H) Millimeters (L × W × H)	3.46 x 2.52 x 1.26 88 x 64 x 32			With mounting ear 4.13 x 2.52 x 1.26 105 x 64 x 32
Net Weight	-	375 g	-	

Note: All specifications are tested by Cree XLamp XP-G and typical at 25°C unless otherwise stated.

Dimming Specifications

Parameter	Min.	Typ.	Max.	Notes
Absolute Maximum Voltage on the 0~10V Input Pin	-20 V	-	20 V	
Source Current on 0~10V Input Pin	0 μA	200 μA	250 μA	
Dimming Output Range	10%Iomax	-	100%Iomax	
Recommended Dimming Input Range	0 V	-	10 V	

Safety & EMC Compliance

Safety Category	Standard
UL/CUL	UL 8750, UL 1310, CAN/CSA-C22.2 No. 250.13, CAN/CSA-C22.2 No. 223-M91
CE	EN 61347-1, EN61347-2-13
KS	KS C 7655
EMI Standards	Notes
EN 55015 ⁽¹⁾	Conducted emission Test & Radiated emission Test
EN 61000-3-2	Harmonic current emissions
EN 61000-3-3	Voltage fluctuations & flicker
FCC Part 15 ⁽¹⁾	ANSI C63.4 Class B
	This device complies with Part 15 of the FCC Rules. Operation is subject to the following two conditions: [1] this device may not cause harmful interference, and [2] this device must accept any interference received, including interference that may cause undesired operation.
EMS Standards	Notes
EN 61000-4-2	Electrostatic Discharge (ESD): 8 kV air discharge, 4 kV contact discharge
EN 61000-4-3	Radio-Frequency Electromagnetic Field Susceptibility Test-RS
EN 61000-4-4	Electrical Fast Transient / Burst-EFT
EN 61000-4-5	Surge Immunity Test: AC Power Line: line to line 4 kV, line to earth 6 kV
EN 61000-4-6	Conducted Radio Frequency Disturbances Test-CS
EN 61000-4-8	Power Frequency Magnetic Field Test
EN 61000-4-11	Voltage Dips
EN 61547	Electromagnetic Immunity Requirements Applies To Lighting Equipment

Note: (1) This LED driver meets the EMI specifications above, but EMI performance of a luminaire that contains it depends also on the other devices connected to the driver and on the fixture itself.

Derating

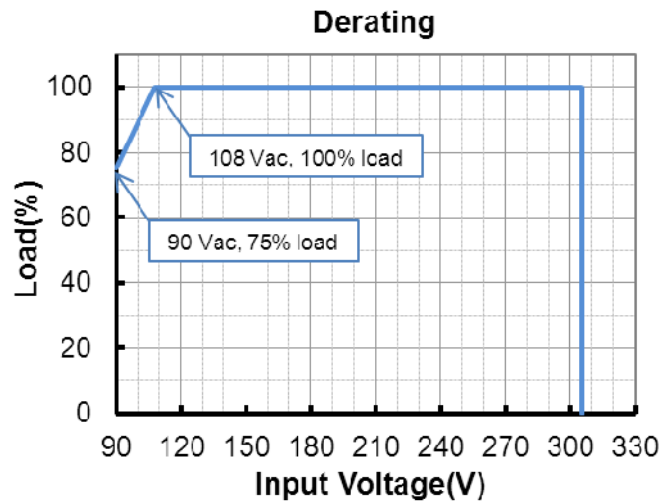

Lifetime vs. Case Temperature

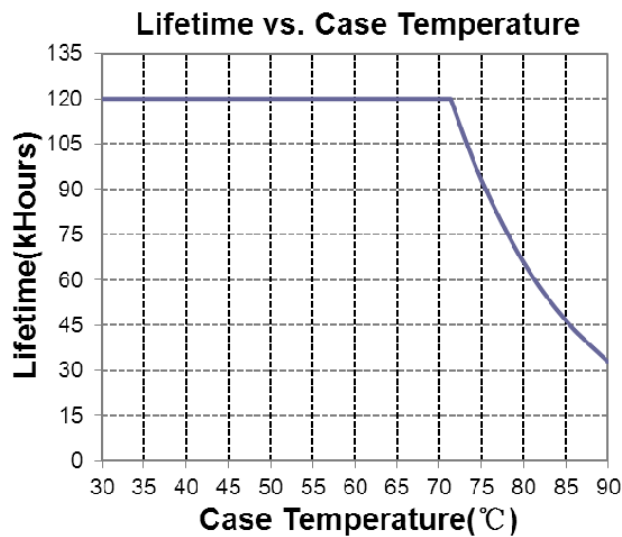

Inrush Current Waveform

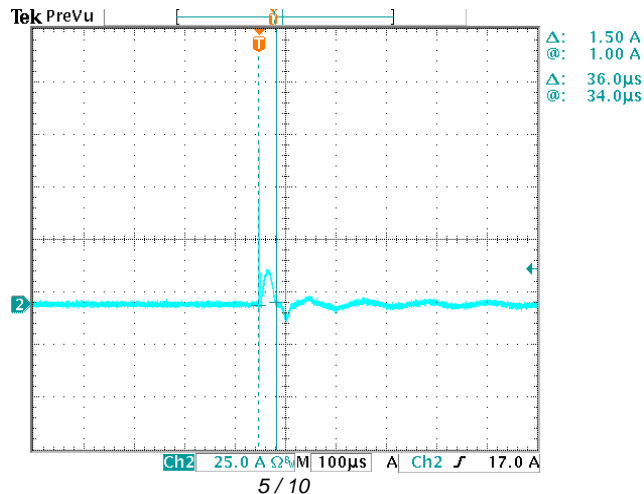

Specifications are subject to changes without notice.

Efficiency vs. Load

EUC-040S070DTM ($I_o=700mA$)
Efficiency vs. Output Voltage

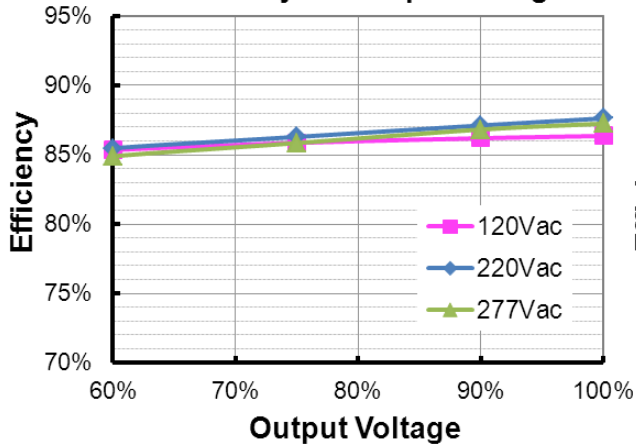

EUC-040S070DTM0004 ($I_o=500mA$)
Efficiency vs. Output Voltage

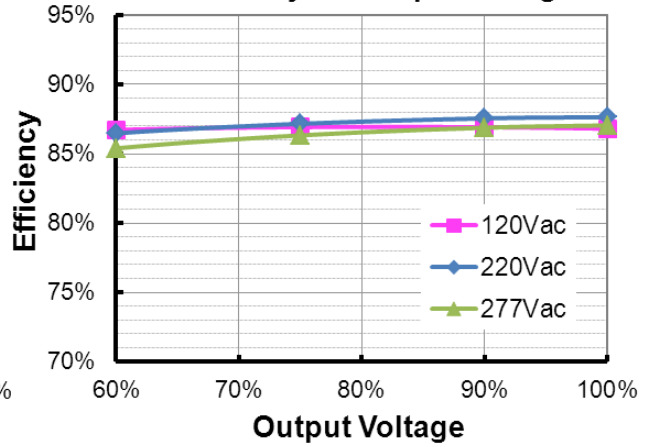

EUC-040S110DTM0001 ($I_o=1050mA$)
Efficiency vs. Output Voltage

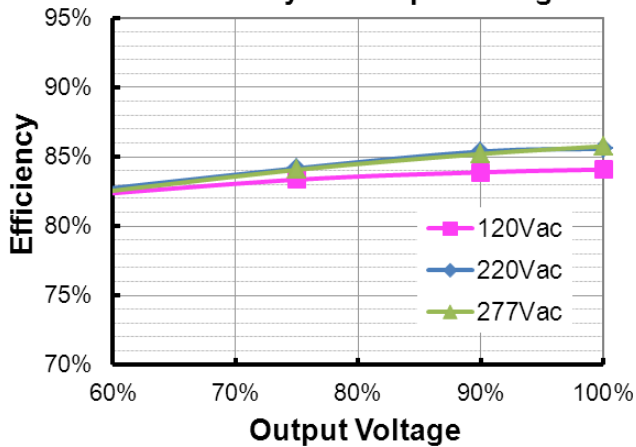

EUC-040S110DTM0005 ($I_o=860mA$)
Efficiency vs. Output Voltage

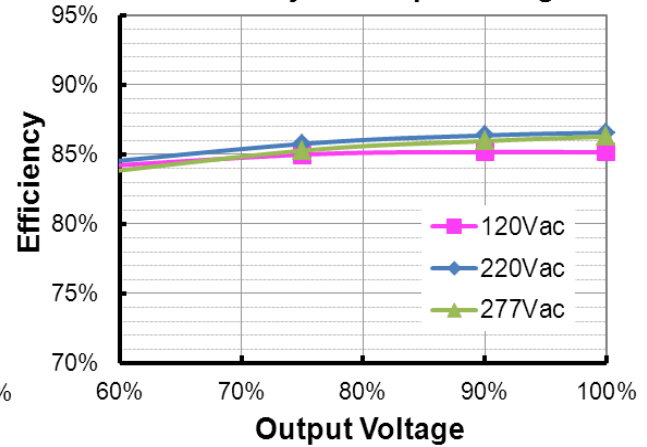

Power Factor

PF vs. Load

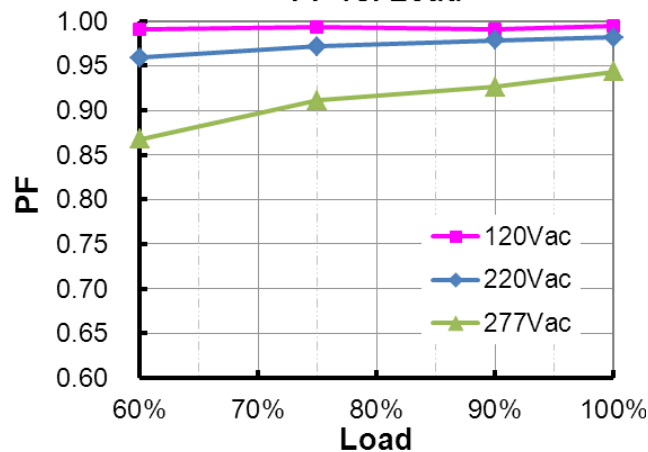

Total Harmonic Distortion

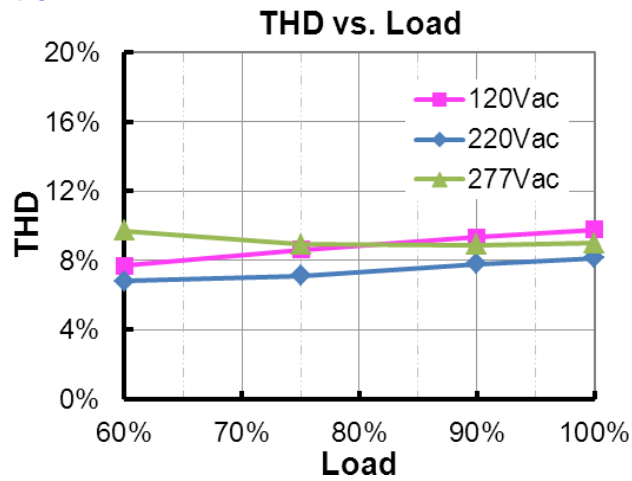

Protection Functions

Parameter		Min.	Typ.	Max.	Notes
Over Voltage Protection		Limits output voltage at no load and in case the normal voltage limit fails.			
Short Circuit Protection		Auto Recovery. No damage shall occur when any output operating in a short circuit condition. The power supply shall be self-recovery when the fault condition is removed.			
Over Temperature Protection		Decreases output current. Returning to normal after over temperature is removed.			
Input Under Voltage Protection		Auto Recovery. Turn off the output when the input voltage falls below $83 \pm 10V$. And the driver will restart when the input voltage exceeds $88 \pm 10V$.			
Input Over Voltage Protection	Input Protection Voltage	330 Vac	340 Vac	350 Vac	Turn off the output when the input voltage exceeds protection voltage.
	Recovery Voltage	300 Vac	320 Vac	340 Vac	Auto Recovery. The driver will restart when the input voltage falls below recovery voltage.
	Max. of Input Over Voltage	-	-	380 Vac	

● Input Over Voltage Protection Diagram

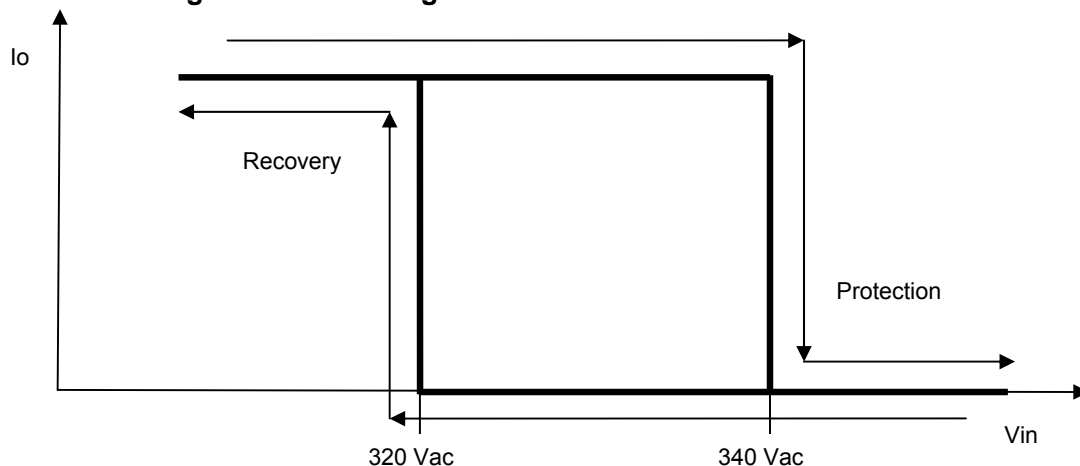

Dimming

● 0-10V Dimming

The recommended implementation is provided below.

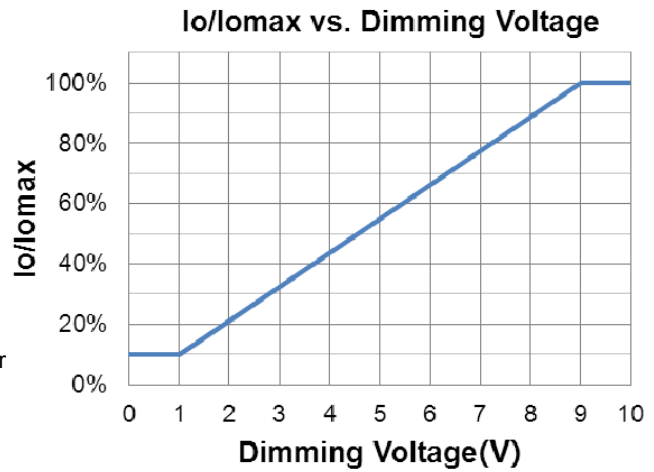
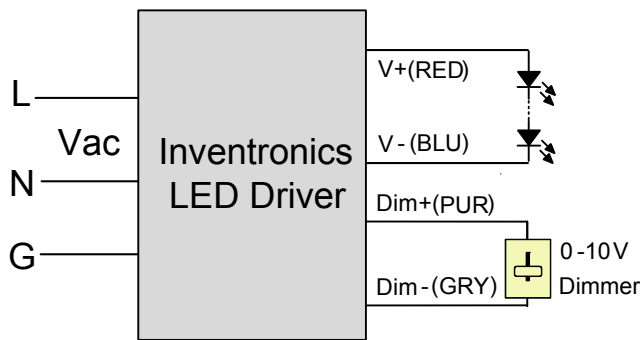

Implementation 1: DC Input

Notes:

1. The dimmer can also be replaced by an active 0-10V voltage source signal or passive components like resistors and zener.
2. Do not connect Dim- to the output V- or V+, otherwise the driver will not work properly.
3. If 0-10V dimming is not used, Dim+ should be open.

Mechanical Outline

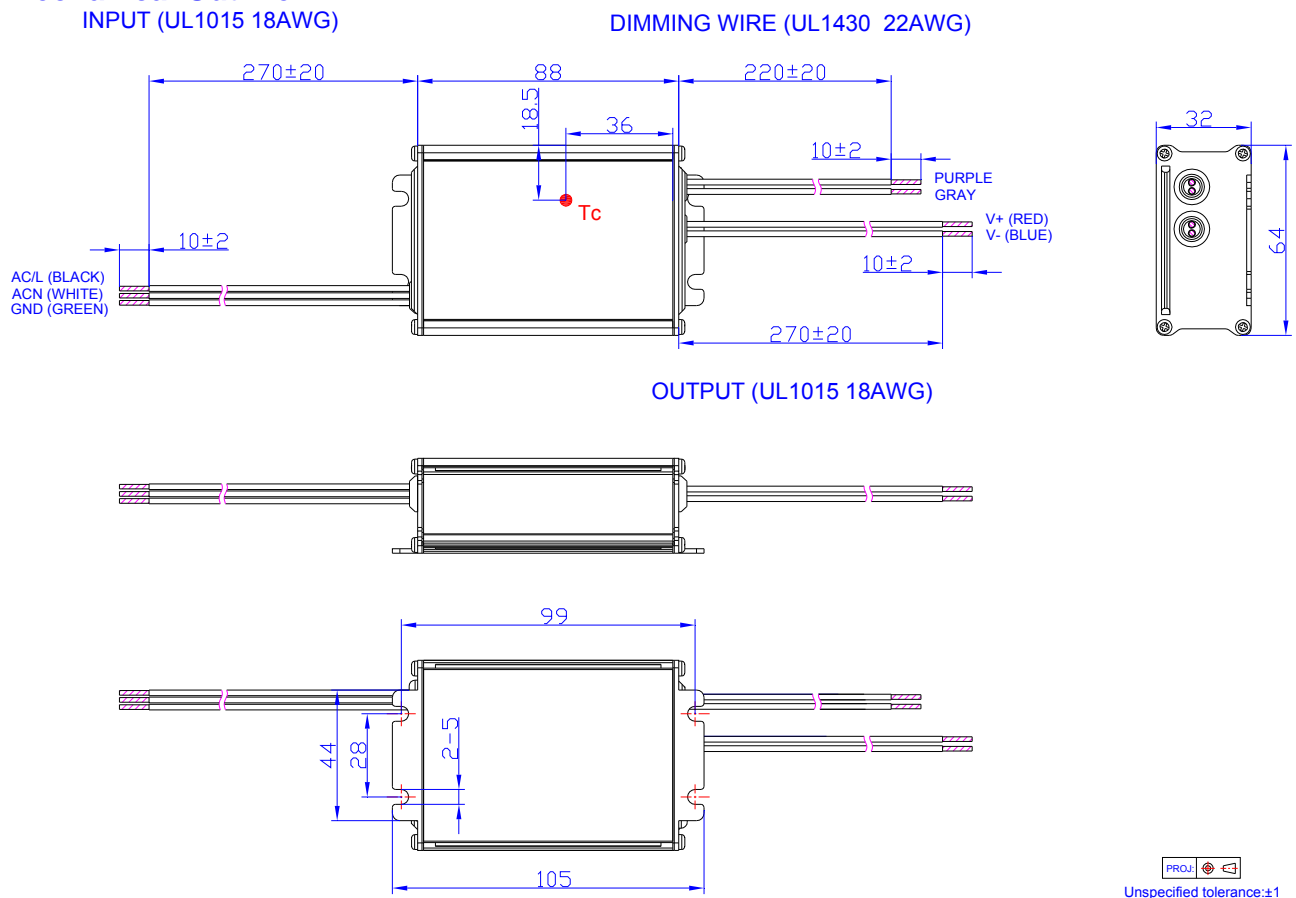

RoHS Compliance

Our products comply with the European Directive 2011/65/EC, calling for the elimination of lead and other hazardous substances from electronic products.

Revision History

Change Date	Rev.	Description of Change		
		Item	From	To
2016-12-30	A	Datasheet Release	/	/
2017-03-09	B	Features	/	Updated
		Models - EUC-040S110DTM0001 & EUC-040S110DTM0005	/	Added
		General Specifications - MTBF	732,000 Hours	546,000 Hours
		Dimming Specifications - Absolute Maximum Voltage on the 0~10V Input Pin	Min.= -20V	Min.=0V
		Power Factor Curve	/	Updated
		Dimming - 0-10V Dimming - Implementation 2: External Resistor	/	Deleted
2017-04-21	C	EUC-040S105DTM0004	/	Deleted
		EUC-040S105DTM	/	Deleted
2017-08-29	D	Features	/	Updated
		Description	/	Updated
		Input Voltage Range(Vac)	108 ~ 305 Vac	90 ~ 305 Vac
		Dimming Specifications - Absolute Maximum Voltage on the 0~10V Input Pin	Min.=0V	Min.= -20V
		Derating Curve	/	Added