

Data sheet | Item number: 2042-3879

Relay module; 230 VAC/VDC; Relay with 3 make contacts and 1 break contact (3a1r)

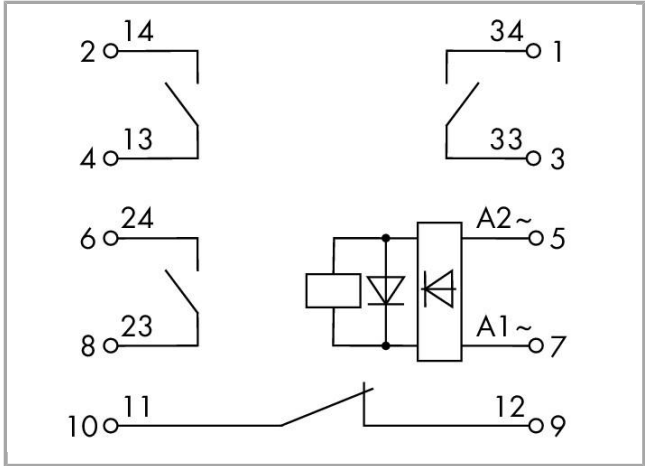

www.wago.com/2042-3879



RoHS Compliant

BOMcheck.net

Similar to picture

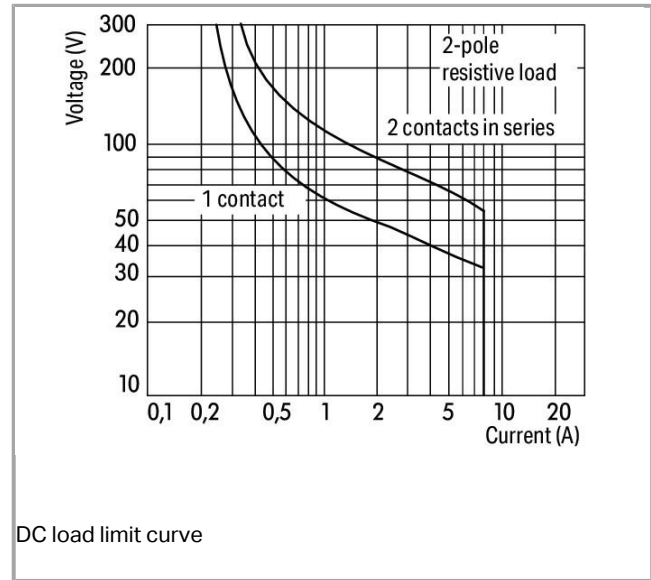
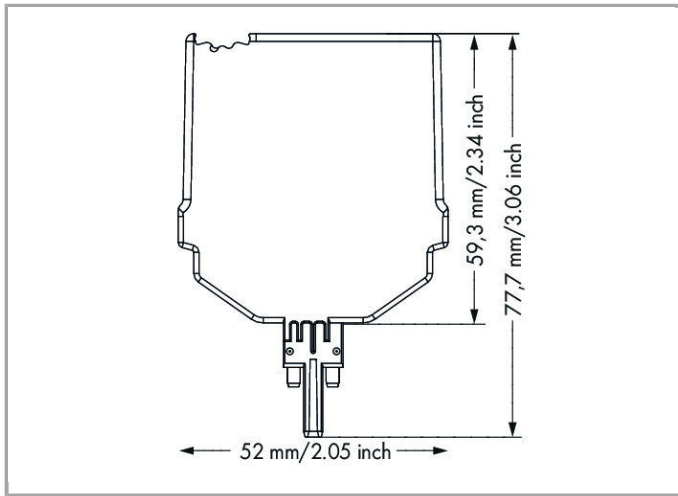

Data

Technical Data

Control circuit

Nominal input voltage U_N	AC/DC 24 ... 230 V
Input voltage range	$\pm 10\%$
Nominal input current at U_N	6 mA (230 V); 58.4 mA (24 V)

Load circuit:

Number of break contacts/switch off contacts	1
Number of make contacts/switch on contacts	3
Contact material (relay)	AgNi
Limiting continuous current	3 A
Max. make current (resistive)	(AC) 15 A / 4 s
Max. switching voltage	AC 250 V
Max. switching power (resistive)	AC 750 VA; DC see load limit curve
Recommended minimum load	12 V / 10 mA
Min. switching current	0 μ A
Pull-in time (typ.)	8 ms
Drop-out time (typ.)	6 ms
Bounce time (typ.)	4 ms
Drop-out time	$\leq 0 \mu$ s
Electrical life (N.O.; resistive load; 23 °C)	100 x 10 ³ switching operations
Mechanical life (N.O.; resistive load; 23 °C)	10 x 10 ⁶ switching operations



Signaling

Status indication	LED green
-------------------	-----------

Safety and protection:

Rated voltage	250 V
Rated impulse voltage	4 kV
Pollution degree	2
Dielectric strength, control/load circuit (AC, 1 min)	3 kV _{rms}
Dielectric strength open contact (AC, 1 min)	1 kV _{rms}
Dielectric strength, channel/channel (AC, 1 min)	2.5 kV _{rms}
Protection class	IP20

Geometrical Data

Width	25.9 mm / 1.02 inch
Height	77.7 mm / 3.059 inch
Height from the surface	59.3 mm / 2.335 inch
Depth	52 mm / 2.047 inch

Mechanical data

Type of mounting	Pluggable module for TOPJOB [®] S carrier terminal block
------------------	---

Material Data

Flammability class per UL94	V0
Fire load	0.269 MJ
Weight	59.2

Environmental Requirements

Pollution degree	2
Surrounding air (operating) temperature at U _N	-40 ... 50 °C
Surrounding air (storage) temperature	-40 ... 85 °C
Max. operating altitude	2000 m

Standards and specifications









Standards/specifications	EN 61010-2-201; EN 61373; EN 50121-3-2
--------------------------	--

Commercial data

Country of origin	DE
GTIN	4055143652001

Compatible products

Marking accessories

	Item no.: 2009-110 Marking strips; on reel; not stretchable; plain; snap-on type	www.wago.com/2009-110
	Item no.: 2009-115 WMB-Inline; for smartPRINTER; on reel; stretchable 5 - 5.2 mm; plain; snap-on type	www.wago.com/2009-115
	Item no.: 2009-115/000-002 WMB-Inline; for Smart Printer; on reel; stretchable 5 - 5.2 mm; plain; snap-on type	www.wago.com/2009-115/000-002
	Item no.: 2009-115/000-006 WMB-Inline; for smartPRINTER; on reel; stretchable 5 - 5.2 mm; plain; snap-on type	www.wago.com/2009-115/000-006
	Item no.: 2009-115/000-007 WMB-Inline; for smartPRINTER; on reel; stretchable 5 - 5.2 mm; plain; snap-on type	www.wago.com/2009-115/000-007
	Item no.: 2009-115/000-012 WMB-Inline; for smartPRINTER; on reel; stretchable 5 - 5.2 mm; plain; snap-on type	www.wago.com/2009-115/000-012
	Item no.: 2009-115/000-017 WMB-Inline; for smartPRINTER; on reel; stretchable 5 - 5.2 mm; plain; snap-on type	www.wago.com/2009-115/000-017
	Item no.: 2009-115/000-023 WMB-Inline; for smartPRINTER; on reel; stretchable 5 - 5.2 mm; plain; snap-on type	www.wago.com/2009-115/000-023
	Item no.: 2009-115/000-024 WMB-Inline; for smartPRINTER; on reel; stretchable 5 - 5.2 mm; plain; snap-on type	www.wago.com/2009-115/000-024
	Item no.: 793-501 WMB marking card; as card; not stretchable; plain; snap-on type	www.wago.com/793-501
	Item no.: 793-501/000-002 WMB marking card; as card; not stretchable; plain; snap-on type	www.wago.com/793-501/000-002
	Item no.: 793-501/000-005 WMB marking card; as card; not stretchable; plain; snap-on type	www.wago.com/793-501/000-005
	Item no.: 793-501/000-006 WMB marking card; as card; not stretchable; plain; snap-on type	www.wago.com/793-501/000-006



Item no.: 793-501/000-007
WMB marking card; as card; not stretchable; plain; snap-on type

www.wago.com/793-501/000-007



Item no.: 793-501/000-012
WMB marking card; as card; not stretchable; plain; snap-on type

www.wago.com/793-501/000-012



Item no.: 793-501/000-017
WMB marking card; as card; not stretchable; plain; snap-on type

www.wago.com/793-501/000-017



Item no.: 793-501/000-023
WMB marking card; as card; not stretchable; plain; snap-on type

www.wago.com/793-501/000-023



Item no.: 793-501/000-024
WMB marking card; as card; not stretchable; plain; snap-on type

www.wago.com/793-501/000-024



Item no.: 793-5501
WMB marking card; as card; for terminal block width 5 - 17.5 mm; stretchable 5 - 5.2 mm; plain; snap-on type

www.wago.com/793-5501



Item no.: 793-5501/000-002
WMB marking card; as card; for terminal block width 5 - 17.5 mm; stretchable 5 - 5.2 mm; plain; snap-on type

www.wago.com/793-5501/000-002



Item no.: 793-5501/000-005
WMB marking card; as card; stretchable 5 - 5.2 mm; plain; snap-on type

www.wago.com/793-5501/000-005



Item no.: 793-5501/000-006
WMB marking card; as card; stretchable 5 - 5.2 mm; plain; snap-on type

www.wago.com/793-5501/000-006



Item no.: 793-5501/000-007
WMB marking card; as card; stretchable 5 - 5.2 mm; plain; snap-on type

www.wago.com/793-5501/000-007



Item no.: 793-5501/000-012
WMB marking card; as card; stretchable 5 - 5.2 mm; plain; snap-on type

www.wago.com/793-5501/000-012



Item no.: 793-5501/000-014
WMB marking card; as card; stretchable 5 - 5.2 mm; plain; snap-on type

www.wago.com/793-5501/000-014



Item no.: 793-5501/000-017
WMB marking card; as card; stretchable 5 - 5.2 mm; plain; snap-on type

www.wago.com/793-5501/000-017



Item no.: 793-5501/000-023
WMB marking card; as card; stretchable 5 - 5.2 mm; plain; snap-on type

www.wago.com/793-5501/000-023



Item no.: 793-5501/000-024
WMB marking card; as card; stretchable 5 - 5.2 mm; plain; snap-on type

www.wago.com/793-5501/000-024

Terminal Block

	Item no.: 2002-1661 Carrier terminal block; for disconnect; fuse or component plug; rail mount; 2-conductor; 5.2 mm wide; gray	www.wago.com/2002-1661
	Item no.: 2002-1761 Carrier terminal block; for disconnect; fuse or component plug; rail mount; 3-conductor; 5.2 mm wide; gray	www.wago.com/2002-1761
	Item no.: 2002-1861 Carrier terminal block; for disconnect; fuse or component plug; rail mount; 4-conductor; 5.2 mm wide; gray	www.wago.com/2002-1861
	Item no.: 2002-1961 Carrier terminal block; for disconnect; fuse or component plug; with additional jumper location; rail mount; 2-conductor; 5.2 mm wide; gray	www.wago.com/2002-1961

End plate

	Item no.: 2002-1691 TOPJOB®S end/intermediate plate; for 2002-16xx series terminal blocks; 1.0 mm wide; gray	www.wago.com/2002-1691
	Item no.: 2002-1692 TOPJOB®S end/intermediate plate; for 2002-16xx series terminal blocks; 1.0 mm wide; orange	www.wago.com/2002-1692
	Item no.: 2002-1791 TOPJOB®S end/intermediate plate; for 2002-17xx series terminal blocks; 1.0 mm wide; gray	www.wago.com/2002-1791
	Item no.: 2002-1792 TOPJOB®S end/intermediate plate; for 2002-17xx series terminal blocks; 1.0 mm wide; orange	www.wago.com/2002-1792
	Item no.: 2002-1891 TOPJOB®S end/intermediate plate; for 2002-18xx series terminal blocks; 1.0 mm wide; gray	www.wago.com/2002-1891
	Item no.: 2002-1892 TOPJOB®S end/intermediate plate; for 2002-18xx series terminal blocks; 1.0 mm wide; orange	www.wago.com/2002-1892

Downloads

Documentation

Additional Information

Disposal; Electrical and electronic equipment, Packaging	V 1.0.0 10-Oct-2018	pdf 265.8 kB	Download
--	------------------------	-----------------	----------

CAD files

CAD data

3D Download 2042-3879	URL	Download
-----------------------	-----	----------



Subject to changes.

WAGO Corporation
Germantown, WI 53022
Phone: 1-800-DIN-RAIL (346-7245) | Fax: (262) 255-6222
Email: info.us@wago.com | Web: www.wago.com

Do you have any questions about our products?
We are always happy to take your call at {0}.