

RoHS 2.0

REV.	ECN NO.	DESCRIPTION	DATE	DESIGN
A0.	/	新版发行	20.04.03	yang
A1.	/	重新核对图面	21.01.06	LiHui

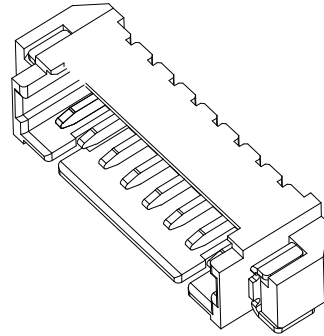

3D View

PIN数	A±0.1	B±0.1	C±0.1
2P	7.60	4.50	1.25
3P	8.85	5.75	2.50
4P	10.10	7.00	3.75
5P	11.35	8.25	5.00
6P	12.60	9.50	6.25
7P	13.85	10.75	7.50
8P	15.10	12.00	8.75

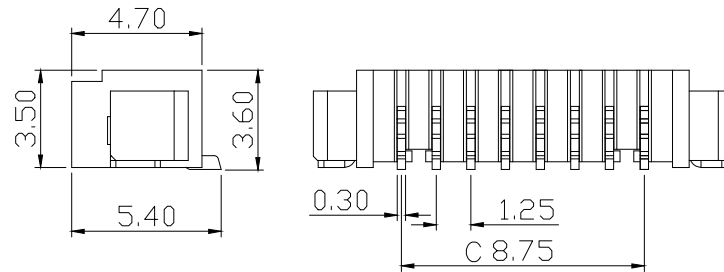
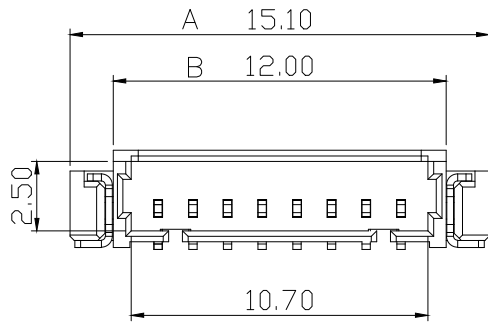
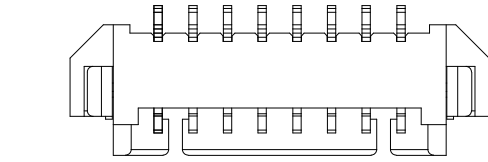

Specifications:

1. Rated Voltage : 125V AC/DC
2. Rated Current : 1A AC,DC
3. Withstand Voltage : 200V AC/minute
4. Contact Resistance : 50mΩ(MAX.)
5. Insulation Resistance : 100MΩ(MIN.)
6. Storage Temperature Range: -40°C~+85°C;
7. Operation Temperature Range: -25°C~+70°C;

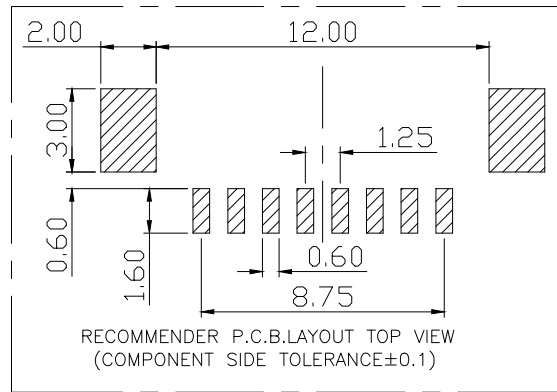
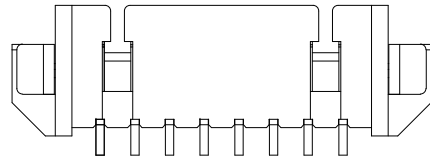

C	插片	黄铜H65	镀镍锡	
B	插针	黄铜H65	镀镍锡	
A	基座	LCP	本色	
序号	品名	材质	电镀/颜色	备注

# 深圳市虹成电子有限公司

UNLESS OTHERWISE, GENERAL TOLERANCE: X. xxx ±0.05 X. xx ±0.15 X. x ±0.25		NAME: 针座1.25卧贴		P/N: HCZZ0001-6	
ANGULAR: X. xx° ±1° X. x° ±3° X. ° ±5°		THIRD ANGLE PROJECTION 	UNIT: MM	SCALE: 1:1	SIZE: A4
DRAWN:		CHECKED:		APPROVED:	