

Features

- Ultra High Efficiency (Up to 93.0%)
- Full Power at Wide Output Current Range (Constant Power)
- Thermal Sensing and Protection for LED Module
- 0-10V/PWM/Timer Dimmable (3 Timer Modes)
- Dim-to-Off with Standby Power ≤ 0.5 W
- Always-on Auxiliary Power: 12Vdc, 200mA (Transient Peak Current up to 400mA)
- Output Lumen Compensation
- Input Surge Protection: 6kV line-line, 10kV line-earth
- All-Around Protection: OVP, SCP, OTP
- Waterproof (IP67)
- SELV Output
- Suitable for Independent Use
- 7 Years Warranty



Description

The EUD-096SxxxDVA series is a 96W, constant-current, programmable LED driver that operates from 90-305 Vac input with excellent power factor. Created for low bay, tunnel and street lights, it provides a dim-to-off mode with low standby power. The high efficiency of these drivers and compact metal case enables them to run cooler, significantly improving reliability and extending product life. To ensure trouble-free operation, protection is provided against input surge, output over voltage, short circuit, and over temperature.

Models

| Adjustable Output Current Range | Full-Power Current Range(1) | Default Output Current | Input Voltage Range(2) | Output Voltage Range | Max. Output Power | Typical Efficiency (3) | Power Factor | | Model Number |
|---------------------------------|-----------------------------|------------------------|----------------------------|----------------------|-------------------|------------------------|--------------|--------|-------------------------------|
| | | | | | | | 120Vac | 220Vac | |
| 45-700mA | 450-700mA | 530 mA | 90~305 Vac/ 127~250 Vdc | 74~213Vdc | 96 W | 91.5% | 0.99 | 0.96 | EUD-096S070DVA |
| 70-1050mA | 700-1050mA | 700 mA | 90~305 Vac/ 127~250 Vdc | 48~137Vdc | 96 W | 92.5% | 0.99 | 0.96 | EUD-096S105DVA |
| 140-2100mA | 1400-2100mA | 2100 mA | 90~305 Vac/ 127~250 Vdc | 24 ~ 69Vdc | 96 W | 93.0% | 0.99 | 0.96 | EUD-096S210DVA ⁽⁴⁾ |
| 245-3500mA | 2450-3500mA | 2800 mA | 90~305 Vac/ 127~250 Vdc | 14 ~ 39Vdc | 96 W | 91.0% | 0.99 | 0.96 | EUD-096S350DVA ⁽⁴⁾ |

- Notes:** (1) Output current range with constant power at 96W
 (2) Certified voltage range: 100-240Vac or 127-250Vdc (except CCC, PSE and KS)
 (3) Measured at full load and 220Vac input (see below "General Specifications" for details).
 (4) SELV Output.

I-V Operating Area

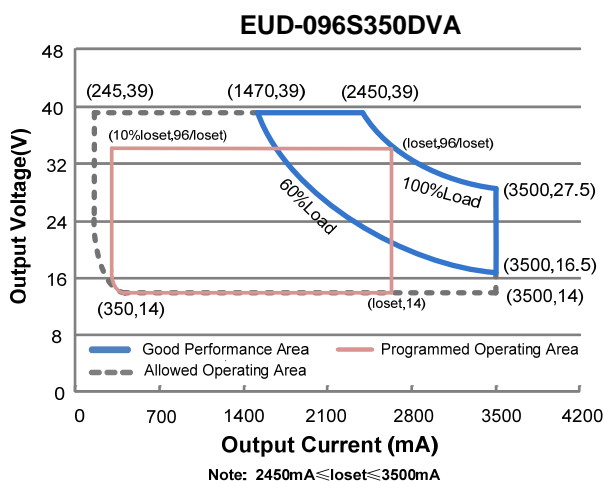
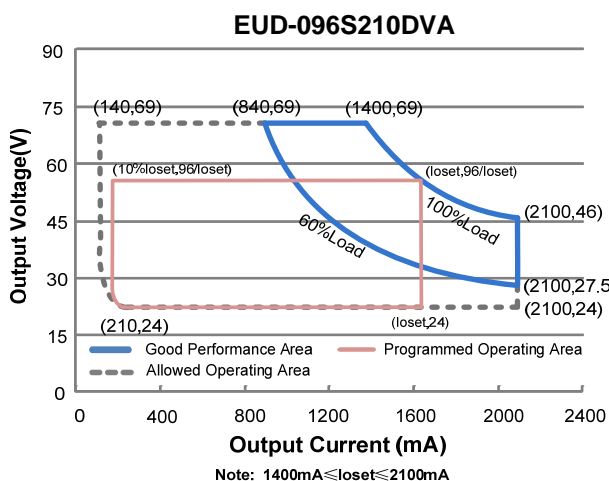
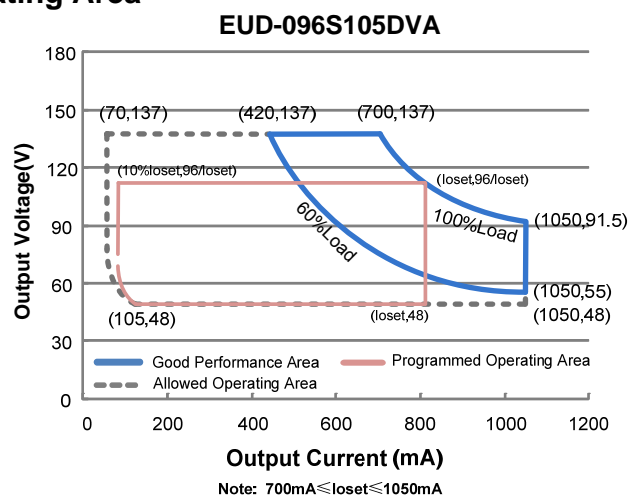
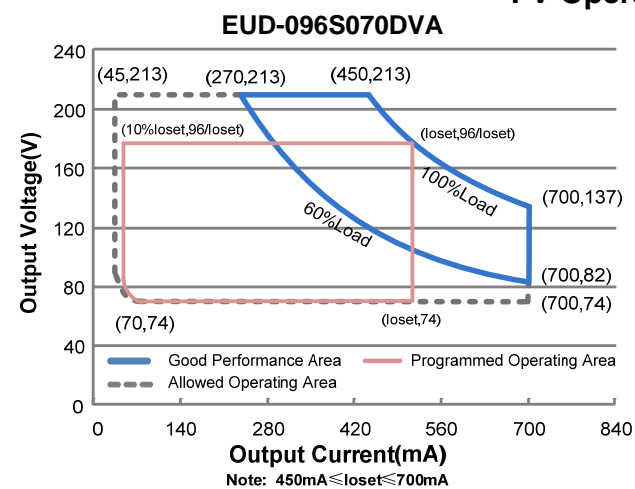

Input Specifications

| Parameter | Min. | Typ. | Max. | Notes |
|----------------------------------|--------|------|-----------------------|--|
| Input Voltage | 90 Vac | - | 305 Vac | 127-250Vdc |
| Input Frequency | 47 Hz | - | 63 Hz | |
| Leakage Current | - | - | 0.70 mA | IEC60598-1; 240Vac/ 60Hz |
| Input AC Current | - | - | 1.32 A | Measured at full load and 100 Vac input. |
| | - | - | 0.60 A | Measured at full load and 220 Vac input. |
| Inrush Current(I ² t) | - | - | 1.10 A ² s | At 220Vac input, 25°C cold start, duration=576 μs, 10%I _{pk} -10%I _{pk} . See Inrush Current Waveform for the details. |
| PF | 0.90 | - | - | At 100-240Vac, 50-60Hz, 60%-100% Load (58-96W) |
| THD | - | - | 20% | |
| THD | - | - | 10% | At 220-240Vac, 50-60Hz, 75%-100% Load (72-96W) |

Output Specifications

| Parameter | Min. | Typ. | Max. | Notes |
|--|----------|----------|----------|--|
| Output Current Tolerance | -5%loset | - | 5%loset | At full load condition |
| Output Current Setting(loset) Range | | | | |
| EUD-096S070DVA | 45 mA | - | 700 mA | |
| EUD-096S105DVA | 70 mA | - | 1050 mA | |
| EUD-096S210DVA | 140 mA | - | 2100 mA | |
| EUD-096S350DVA | 245 mA | - | 3500 mA | |
| Output Current Setting Range with Constant Power | | | | |
| EUD-096S070DVA | 450 mA | - | 700 mA | |
| EUD-096S105DVA | 700 mA | - | 1050 mA | |
| EUD-096S210DVA | 1400 mA | - | 2100 mA | |
| EUD-096S350DVA | 2450 mA | - | 3500 mA | |
| Total Output Current Ripple (pk-pk) | - | 5%lomax | 10%lomax | At full load condition, 20 MHz BW |
| Output Current Ripple at < 200 Hz (pk-pk) | - | 2%lomax | - | At full load condition. Only this component of ripple is associated with visible flicker. |
| Startup Overshoot Current | - | - | 10%lomax | At full load condition |
| No Load Output Voltage | | | | |
| EUD-096S070DVA | - | - | 240 V | |
| EUD-096S105DVA | - | - | 170 V | |
| EUD-096S210DVA | - | - | 90 V | |
| EUD-096S350DVA | - | - | 44 V | |
| Line Regulation | - | - | ±0.5% | Measured at full load |
| Load Regulation | - | - | ±1.5% | |
| Turn-on Delay Time | - | - | 1.0 s | Measured at 120Vac input, 60%-100% Load |
| | - | - | 0.5 s | Measured at 220Vac input, 60%-100% Load |
| Temperature Coefficient of loset | - | 0.03%/°C | - | Case temperature = 0°C ~Tc max |
| 12V Auxiliary Output Voltage | 10.8 V | 12 V | 13.2 V | |
| 12V Auxiliary Output Source Current | 0 mA | - | 200 mA | Return terminal is "Dim" |
| 12V Auxiliary Output Transient Peak Current | - | - | 400 mA | 400mA peak for a maximum duration of 300ms in a 2s period during which time the average should not exceed 200mA. |

Note: All specifications are typical at 25°C unless otherwise stated.

General Specifications

| Parameter | Min. | Typ. | Max. | Notes |
|---|--|--|--------------------------------------|--|
| Efficiency at 120 Vac input: EUD-096S070DVA I _o = 450 mA I _o = 700 mA EUD-096S105DVA I _o = 700 mA I _o = 1050 mA EUD-096S210DVA I _o = 1400 mA I _o = 2100 mA EUD-096S350DVA I _o = 2450 mA I _o = 3500 mA | 87.0% 85.5% 88.0% 86.5% 88.0% 86.0% 86.5% 84.5% | 90.0% 88.5% 91.0% 89.5% 91.0% 89.0% 89.5% 87.5% | - - - - - - - - | Measured at full load and steady-state temperature in 25°C ambient; (Efficiency will be about 2.0% lower if measured immediately after startup.) |
| Efficiency at 220 Vac input: EUD-096S070DVA I _o = 450 mA I _o = 700 mA EUD-096S105DVA I _o = 700 mA I _o = 1050 mA EUD-096S210DVA I _o = 1400 mA I _o = 2100 mA EUD-096S350DVA I _o = 2450 mA I _o = 3500 mA | 89.5% 88.5% 90.5% 88.5% 91.0% 88.5% 89.0% 87.5% | 91.5% 90.5% 92.5% 90.5% 93.0% 90.5% 91.0% 89.5% | - - - - - - - - | Measured at full load and steady-state temperature in 25°C ambient; (Efficiency will be about 2.0% lower if measured immediately after startup.) |
| Efficiency at 277 Vac input: EUD-096S070DVA I _o = 450 mA I _o = 700 mA EUD-096S105DVA I _o = 700 mA I _o = 1050 mA EUD-096S210DVA I _o = 1400 mA I _o = 2100 mA EUD-096S350DVA I _o = 2450 mA I _o = 3500 mA | 90.0% 88.5% 91.0% 89.0% 91.0% 89.0% 89.5% 87.5% | 92.0% 90.5% 93.0% 91.0% 93.0% 91.0% 91.5% 89.5% | - - - - - - - - | Measured at full load and steady-state temperature in 25°C ambient; (Efficiency will be about 2.0% lower if measured immediately after startup.) |
| Standby power | - | - | 0.5 W | Measured at 230Vac/50Hz; Dimming off |
| MTBF | - | 229,000 Hours | - | Measured at 220Vac input, 80%Load and 25°C ambient temperature (MIL-HDBK-217F) |
| Lifetime | - | 104,000 Hours | - | Measured at 220Vac input, 80%Load and 70°C case temperature; See lifetime vs. Tc curve for the details |
| Operating Case Temperature for Safety T _{c_s} | -40°C | - | +90°C | |
| Operating Case Temperature for Warranty T _{c_w} | -40°C | - | +75°C | Case temperature for 7 years warranty. <i>Please see Inventronics Warranty Statement for complete details.</i> |
| Storage Temperature | -40°C | - | +85°C | Humidity: 5%RH to 100%RH |
| Dimensions Inches (L × W × H) Millimeters (L × W × H) | 7.09 × 2.66 × 1.44 180 × 67.5 × 36.5 | | | With mounting ear 7.92 × 2.66 × 1.44 201 × 67.5 × 36.5 |

General Specifications (Continued)

| Parameter | Min. | Typ. | Max. | Notes |
|------------|------|-------|------|-------|
| Net Weight | - | 960 g | - | |

Note: All specifications are typical at 25°C unless otherwise stated.

Dimming Specifications

| Parameter | Min. | Typ. | Max. | Notes | |
|--|--|--------------------------------|--------|--|---|
| Absolute Maximum Voltage on the Vdim (+) Pin | -20 V | - | 20 V | | |
| Source Current on Vdim (+)Pin | 200 uA | 300 uA | 450 uA | Vdim(+) = 0 V | |
| Dimming Output Range | EUD-096S070DVA EUD-096S105DVA EUD-096S210DVA EUD-096S350DVA | 10%loset | - | loset | 450mA ≤ loiset ≤ 700mA 700mA ≤ loiset ≤ 1050mA 1400mA ≤ loiset ≤ 2100mA 2450mA ≤ loiset ≤ 3500mA |
| | EUD-096S070DVA EUD-096S105DVA EUD-096S210DVA EUD-096S350DVA | 45mA 70mA 140mA 245mA | - | loset | 45mA ≤ loiset < 450mA 70mA ≤ loiset < 700mA 140mA ≤ loiset < 1400mA 245mA ≤ loiset < 2450mA |
| Recommended Dimming Input Range | 0 V | - | 10 V | Default 0-10V dimming mode. | |
| Dim off Voltage | 0.35 V | 0.5 V | 0.65 V | | |
| Dim on Voltage | 0.55 V | 0.7 V | 0.85 V | | |
| Hysteresis | - | 0.2 V | - | | |
| PWM_in High Level | 3 V | - | 10 V | Dimming mode set to PWM in PC interface. | |
| PWM_in Low Level | -0.3 V | - | 0.6 V | | |
| PWM_in Frequency Range | 200 Hz | - | 3 KHz | | |
| PWM_in Duty Cycle | 1% | - | 99% | | |
| PWM Dimming off (Positive Logic) | 2% | 5% | 8% | | |
| PWM Dimming on (Positive Logic) | 4% | 7% | 10% | | |
| PWM Dimming off (Negative Logic) | 92% | 95% | 98% | | |
| PWM Dimming on (Negative Logic) | 90% | 93% | 96% | | |
| Hysteresis | - | 2% | - | | |

Note: All specifications are typical at 25 °C unless stated otherwise.

Safety &EMC Compliance

| Safety Category | Standard |
|-----------------|--------------------------|
| CE | EN 61347-1, EN61347-2-13 |
| KS | KS C 7655 |

Safety & EMC Compliance (Continued)

| EMI Standards | Notes |
|-------------------------|---|
| EN 55015 ⁽¹⁾ | Conducted emission Test & Radiated emission Test |
| EN 61000-3-2 | Harmonic current emissions |
| EN 61000-3-3 | Voltage fluctuations & flicker |
| EMS Standards | Notes |
| EN 61000-4-2 | Electrostatic Discharge (ESD): 8 kV air discharge, 4 kV contact discharge |
| EN 61000-4-3 | Radio-Frequency Electromagnetic Field Susceptibility Test-RS |
| EN 61000-4-4 | Electrical Fast Transient / Burst-EFT |
| EN 61000-4-5 | Surge Immunity Test: AC Power Line: line to line 6 kV, line to earth 10 kV ⁽²⁾ |
| EN 61000-4-6 | Conducted Radio Frequency Disturbances Test-CS |
| EN 61000-4-8 | Power Frequency Magnetic Field Test |
| EN 61000-4-11 | Voltage Dips |
| EN 61547 | Electromagnetic Immunity Requirements Applies To Lighting Equipment |

- Note:** (1) This LED driver meets the EMI specifications above, but EMI performance of a luminaire that contains it depends also on the other devices connected to the driver and on the fixture itself.
 (2) To perform electric strength (hi-pot) testing, the “GDT ground disconnect” (nut and metal lock sheet) on the driver end-cap should be removed temporarily to prevent the internal gas discharge tube from conducting (as allowed by IEC 60598-1 Clause 10.2). After testing is completed, these items must be reinstalled to restore line-to-earth surge protection and secure the end cap.

Lifetime vs. Case Temperature

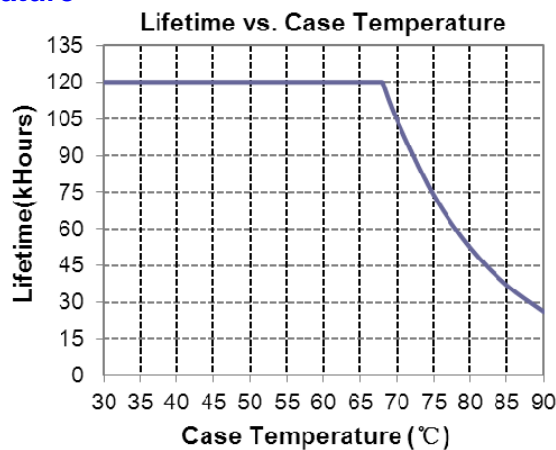

Inrush Current Waveform

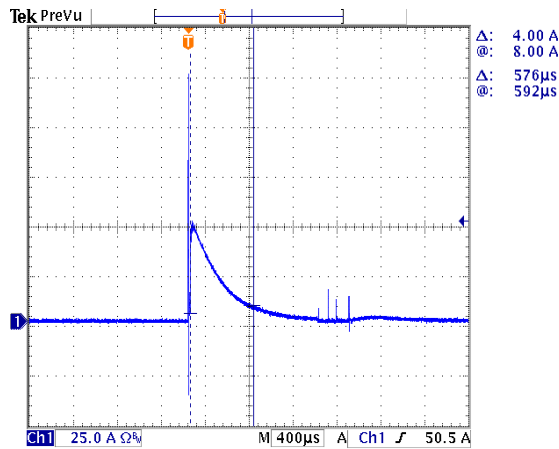

Efficiency vs. Load

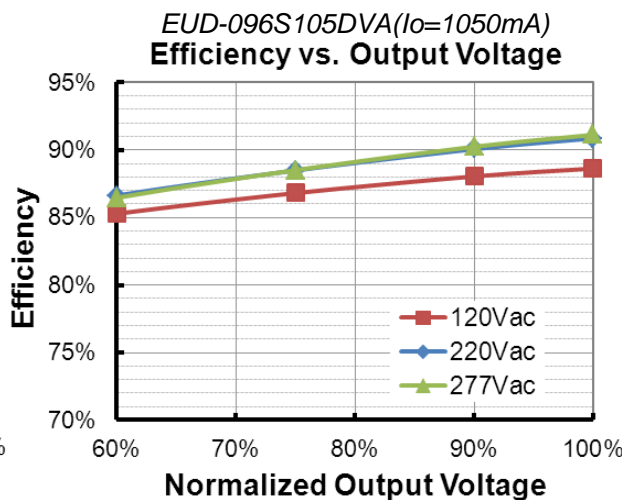
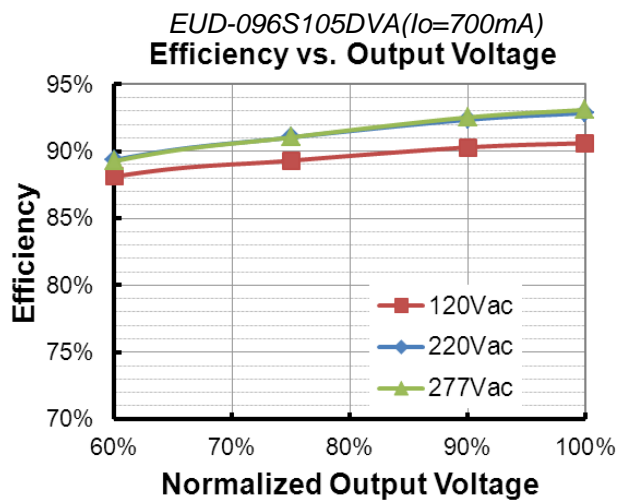
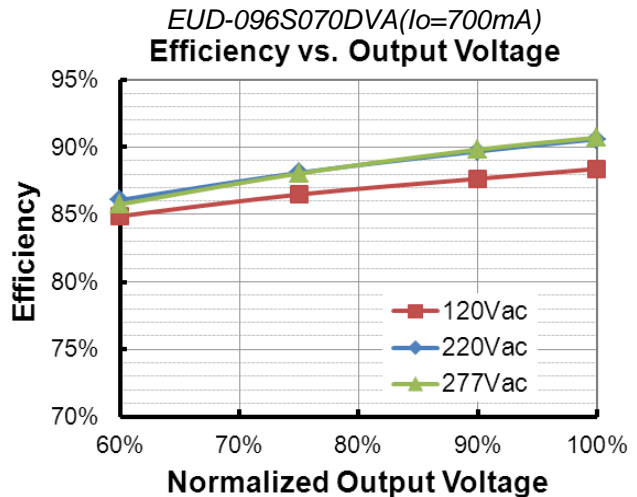
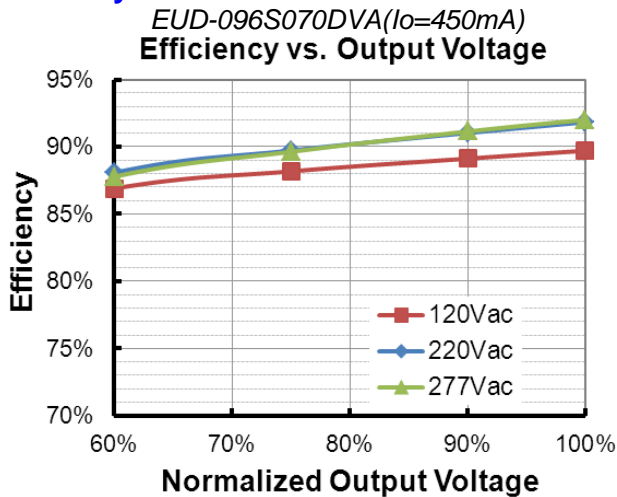

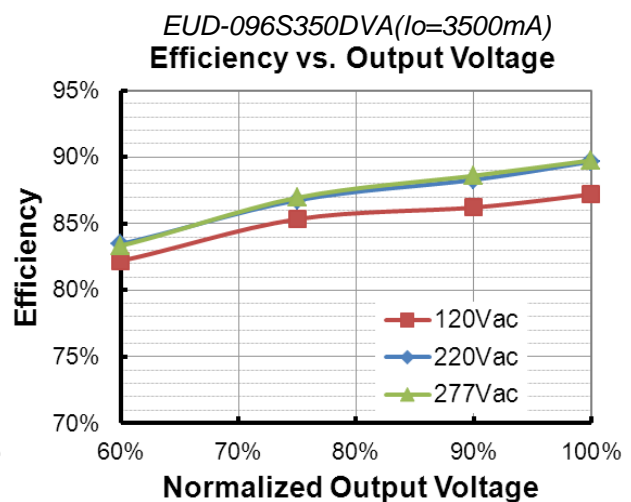
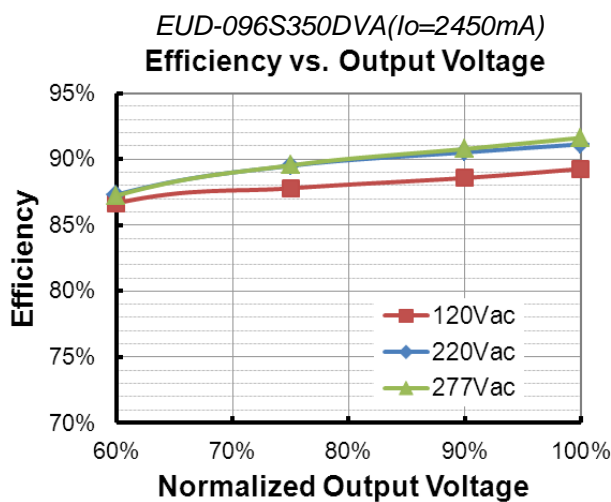
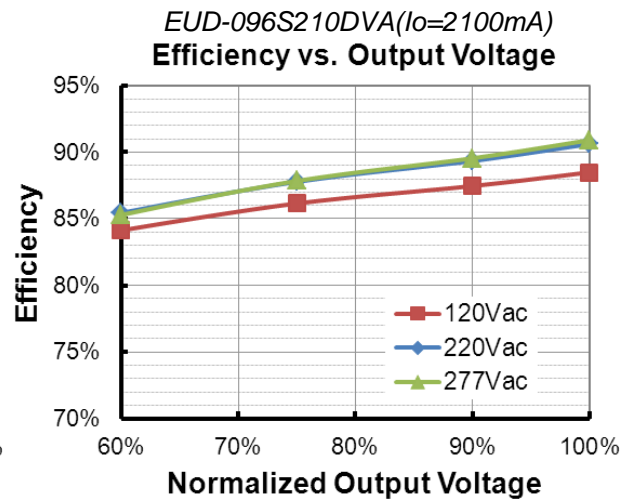
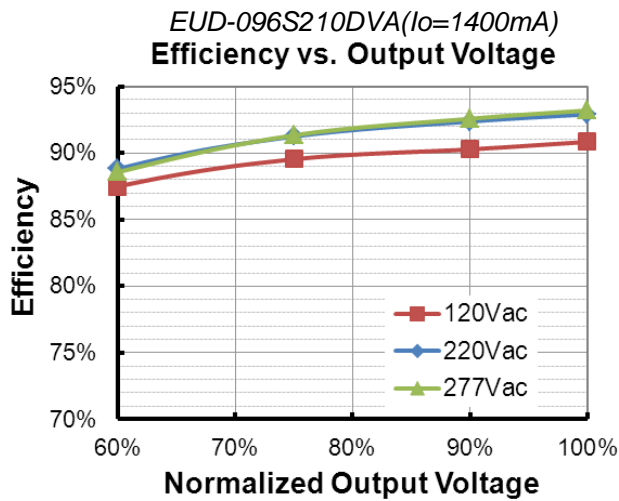

Power Factor

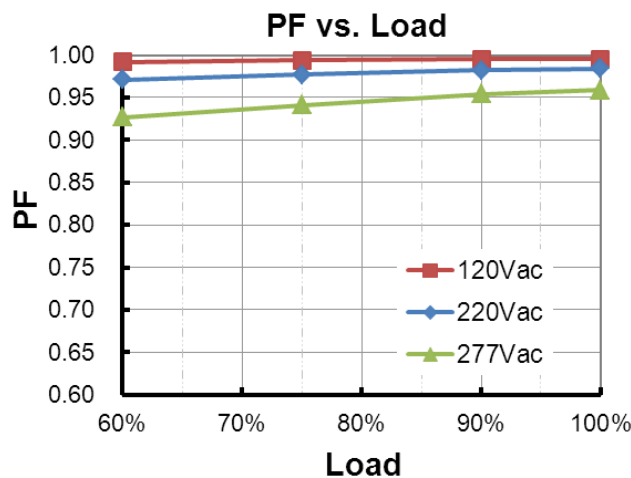

Total Harmonic Distortion

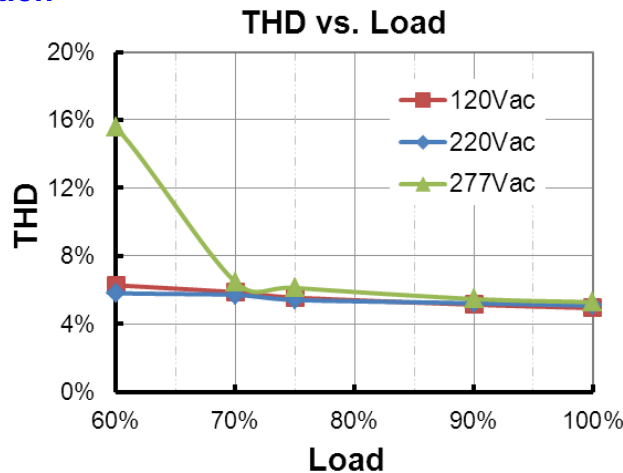

Protection Functions

| Parameter | | Min. | Typ. | Max. | Notes |
|---------------------------------|--------------------------|--|-----------|-----------|---|
| External Thermal Protection NTC | R1 | - | 7.81 kOhm | - | When R_NTC falls below R1, External Thermal Protection is triggered, reducing output current until R2 is reached. |
| | R2 | - | 4.16 kOhm | - | When R_NTC is less than R2, output current is reduced to the programmed "Protection Current Floor." |
| | Protection Current Floor | 10%loset | 60%loset | 100%loset | 10%loset > lomin (default setting is 60%) |
| | | lomin | 60%loset | 100%loset | 10%loset ≤ lomin (default setting is 60%) |
| Over Temperature Protection | | Decreases output current, returning to normal after over temperature is removed. | | | |
| Short Circuit Protection | | Auto Recovery. No damage will occur when any output is short circuited. The output shall return to normal when the fault condition is removed. | | | |
| Over Voltage Protection | | Limits output voltage at no load and in case the normal voltage limit fails. | | | |

Dimming

● 0-10V Dimming

The recommended implementation of the dimming control is provided below.

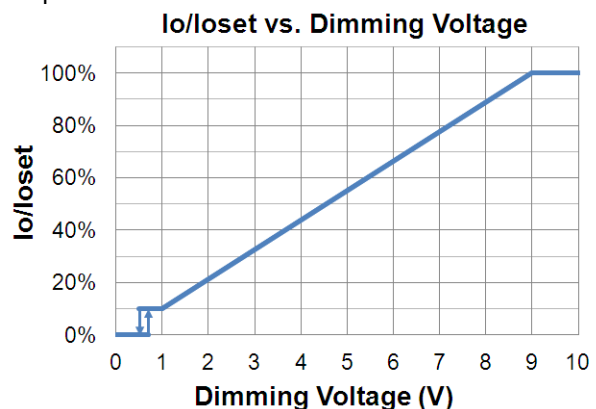
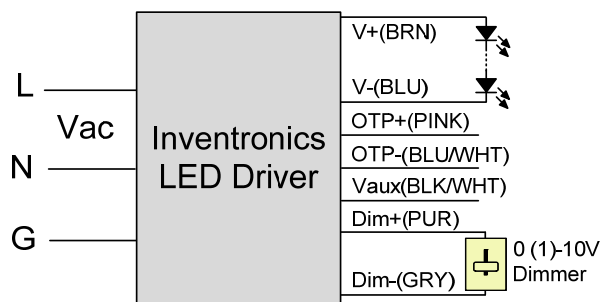

Implementation 1: DC Input

Notes:

1. The dimmer can also be replaced by an active 0-10V voltage source signal or passive components like resistors and zener.
2. Do NOT connect Dim- to the output V- or V+, otherwise the driver will not work properly.
3. If 0-10V dimming is not used, Dim + should be open.

● **PWM Dimming**

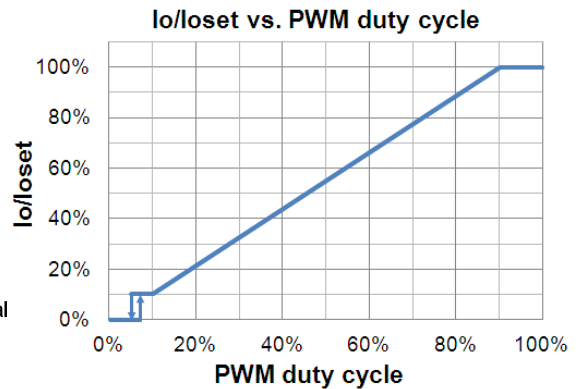
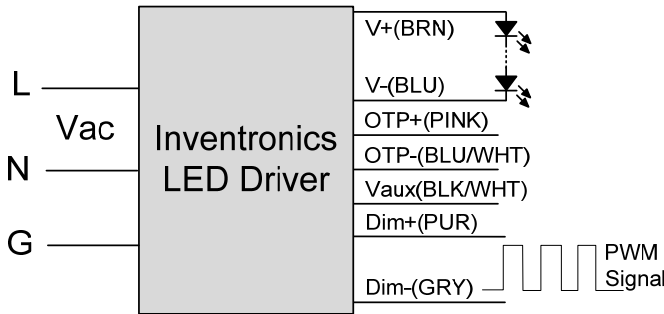

Implementation 2: Positive logic

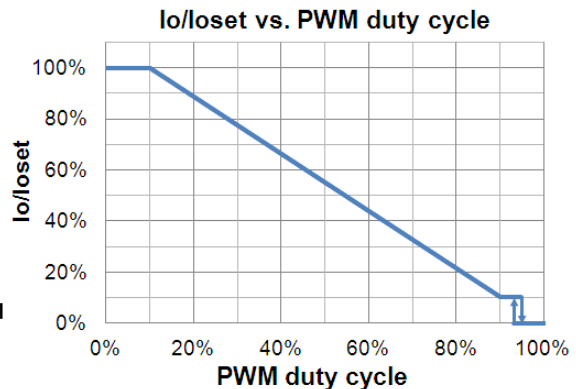
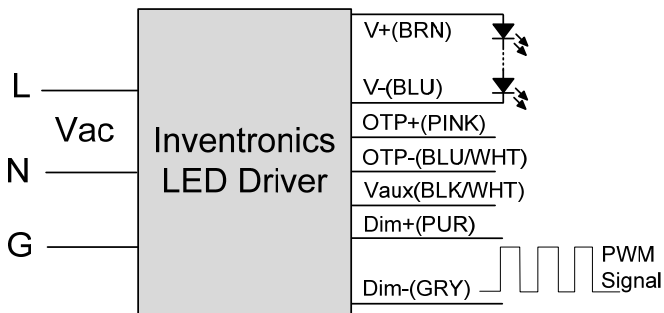

Implementation 3: Negative logic

● **Time Dimming**

Time dimming control includes 3 kinds of modes, they are Self Adapting-Midnight, Self Adapting-Percentage and Traditional Timer.

- **Self Adapting-Midnight:** Automatically adjusts the dimming curve based on the on-time of past two days (if difference <15 minutes), assuming that the center point of the dimming curve is midnight local time.
- **Self Adapting-Percentage:** Automatically adjusts the on-time of each step by a constant percentage = (actual on-time for the past 2 days if difference <15 min) / (programmed on-time from the dimming curve).
- **Traditional Timer:** Follows the programmed timing curve after power on with no changes.

● **Output Lumen Compensation**

Output Lumen Compensation (OLC) may be used to maintain constant light output over the life of the LEDs by driving them at a reduced current when new, then gradually increasing the drive current over time to counteract LED lumen degradation.

Programming Connection Diagram

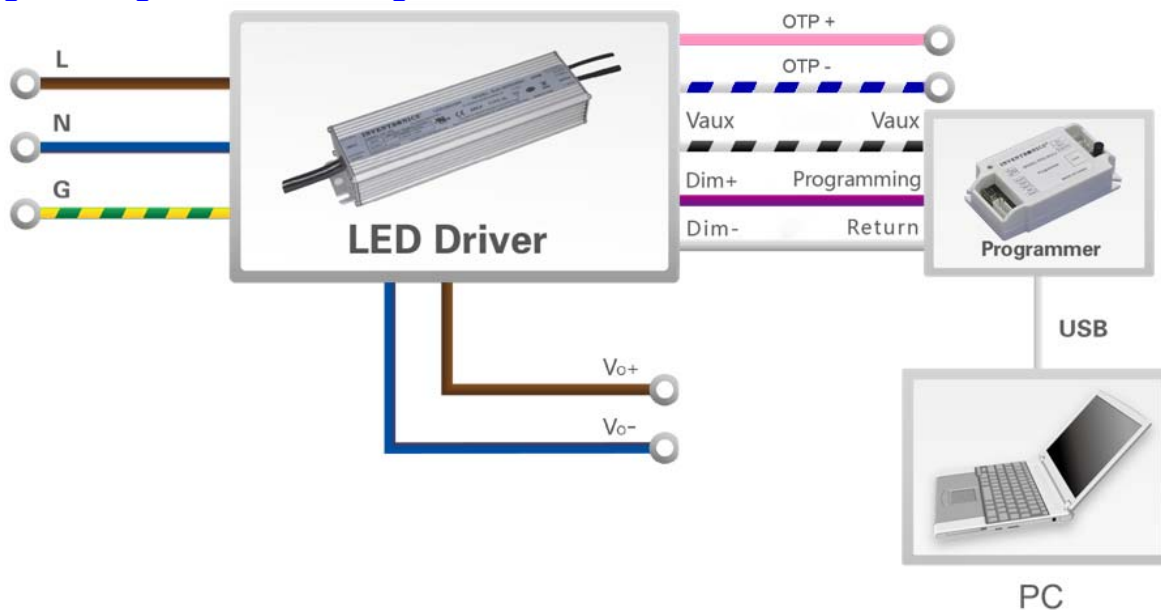

Note: The driver does not need to be powered on during the programming process.

- Please refer to [PRG-MUL2](#) (Programmer) datasheet for details.

Mechanical Outline

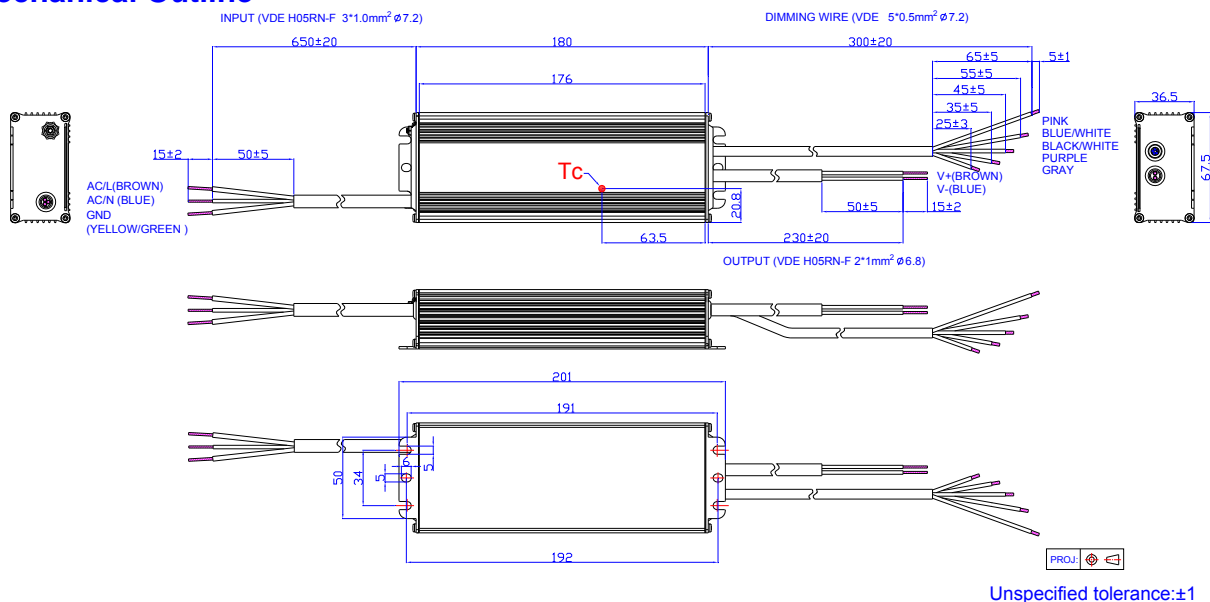

RoHS Compliance

Our products comply with the European Directive 2011/65/EC, calling for the elimination of lead and other hazardous substances from electronic products.

Revision History

| Change Date | Rev. | Description of Change | | |
|-------------|------|--|---|---------|
| | | Item | From | To |
| 2016-07-05 | A | Datasheets Release | / | / |
| 2017-10-27 | B | Features | Always-on Auxiliary Power | Added |
| | | Features | 7 Years Warranty | Added |
| | | Input Specifications | PF/THD | Updated |
| | | Output Specifications | Temperature Coefficient of I _o set | Updated |
| | | Output Specifications | 12V Auxiliary Output Transient Peak Current | Added |
| | | Operating Case Temperature for Warranty T _{c_w} | / | Updated |
| | | Mechanical Outline | / | Updated |