

-40V P-Channel Enhancement Mode MOSFET

Description

The AO4443 uses advanced trench technology to provide excellent $R_{DS(ON)}$, low gate charge and operation with gate voltages as low as 2.5V. This device is suitable for use as a Battery protection or in other Switching application.

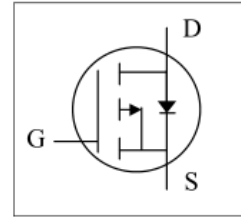

General Features

$V_{DS} = -40V$ $I_D = -8 A$

$R_{DS(ON)} < 37m\Omega @ V_{GS}=10V$

Application

Battery protection

Load switch

Uninterruptible power supply

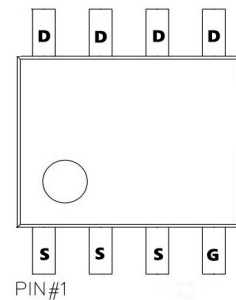

Absolute Maximum Ratings ($T_A=25^\circ C$)

Symbol	Parameter	Value	Unit
V_{DS}	Drain-Source Voltage ($V_{GS}=0V$)	-40	V
V_{GS}	Gate-Source Voltage ($V_{DS}=0V$)	± 20	V
I_D	Drain Current-Continuous($T_c=25^\circ C$)	-20	A
	Drain Current-Continuous($T_c=100^\circ C$)	-8	A
$I_{DM (pluse)}$	(Note 1) Drain Current-Continuous@ Current-Pulsed	-20	A
P_D	Maximum Power Dissipation($T_c=25^\circ C$)	37.5	W
	Maximum Power Dissipation($T_c=100^\circ C$)	19	W
T_J, T_{STG}	Operating Junction and Storage Temperature Range	-55 To 175	$^\circ C$
R_{JC}	Thermal Resistance, Junction-to-Case	4	$^\circ C/W$

-40V P-Channel Enhancement Mode MOSFET

Electrical Characteristics (TA=25°C unless otherwise noted)

Symbol	Parameter	Conditions	Min	Typ	Max	Unit
BV _{DSS}	Drain-Source Breakdown Voltage	V _{GS} =0V, I _D =-250μA	-40			V
I _{DSS}	Zero Gate Voltage Drain Current	V _{DS} =-32V, V _{GS} =0V			-1	μA
I _{GSS}	Gate-Body Leakage Current	V _{GS} =±20V, V _{DS} =0V			±100	nA
V _{GS(th)}	Gate Threshold Voltage	V _{DS} =V _{GS} , I _D =-250μA	-1	-2	-3	V
g _{Fs}	Forward Transconductance	V _{DS} =-5V, I _D =-10A		25		S
R _{DS(on)}	Drain-Source On-State Resistance	V _{GS} =-10V, I _D =-20A		35	46	mΩ
		V _{GS} =-4.5V, I _D =-10A		42	52	mΩ
C _{iss}	Input Capacitance	V _{DS} =-25V, V _{GS} =0V, f=1.0MHz		840		pF
C _{oss}	Output Capacitance			92		pF
C _{rss}	Reverse Transfer Capacitance			60		pF
t _{d(on)}	Turn-on Delay Time	V _{GS} =-10V, V _{DS} =-20V, R _L =1.6Ω, R _{GEN} =3Ω		5		nS
t _r	Turn-on Rise Time			12		nS
t _{d(off)}	Turn-Off Delay Time			20		nS
t _f	Turn-Off Fall Time			4.5		nS
Q _g	Total Gate Charge	V _{GS} =-10V, V _{DS} =-20V, I _D =-15A		20		nC
Q _{gs}	Gate-Source Charge			2.5		nC
Q _{gd}	Gate-Drain Charge			4.5		nC
I _{SD}	Source-Drain Current(Body Diode)				-20	A
V _{SD}	Forward on Voltage	V _{GS} =0V, I _S =-20A			-1.2	V

Notes 1.Repetitive Rating: Pulse width limited by maximum junction temperature

Switch Time Test Circuit and Switching Waveforms:

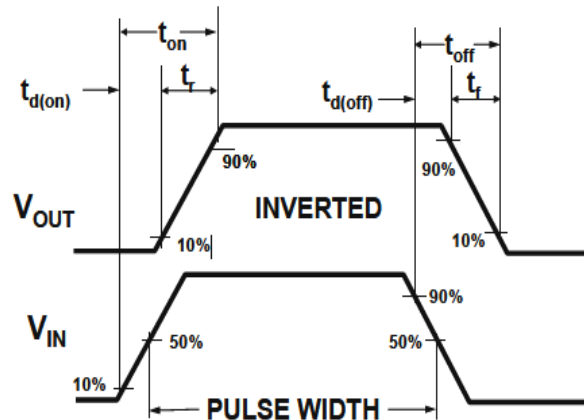
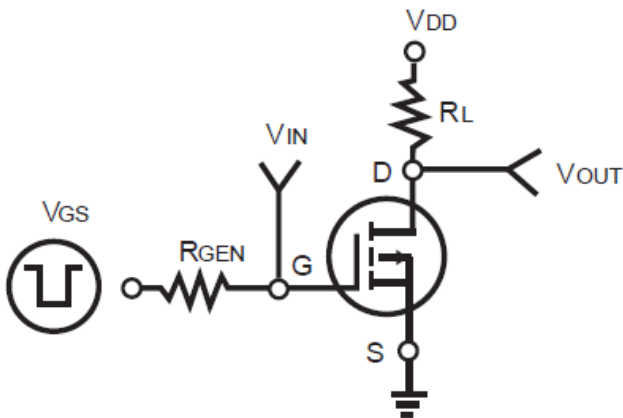

TYPICAL ELECTRICAL AND THERMAL CHARACTERISTICS (Curves)

Figure1. Power Dissipation

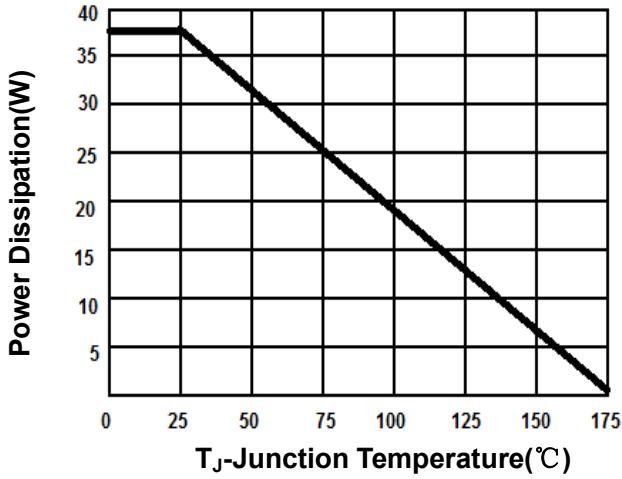

Figure2. Drain Current

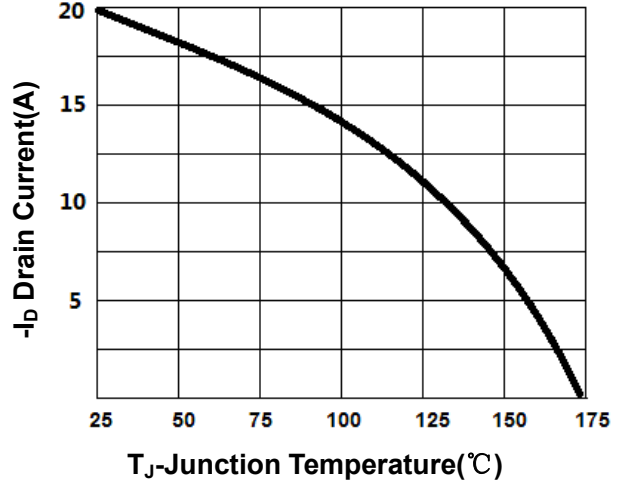

Figure3. Output Characteristics

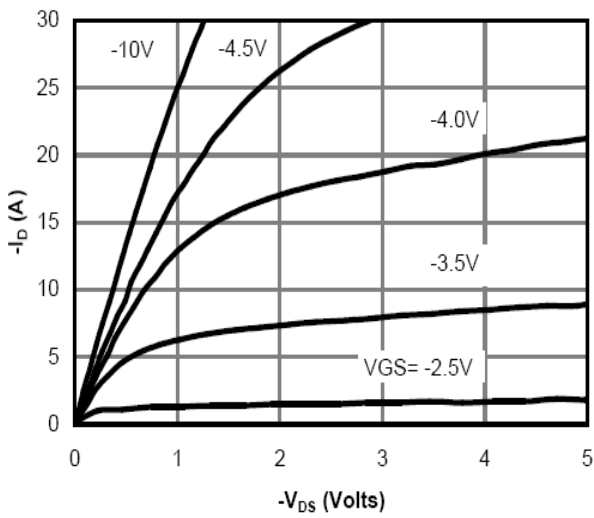
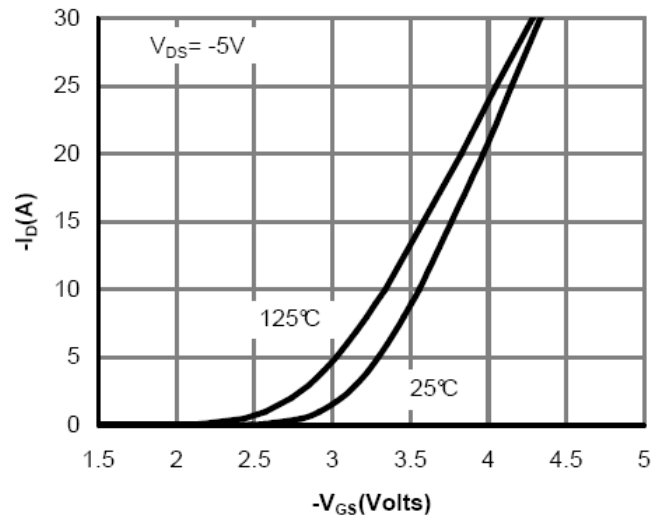

Figure4. Transfer Characteristics



-40V P-Channel Enhancement Mode MOSFET

Figure5. Capacitance

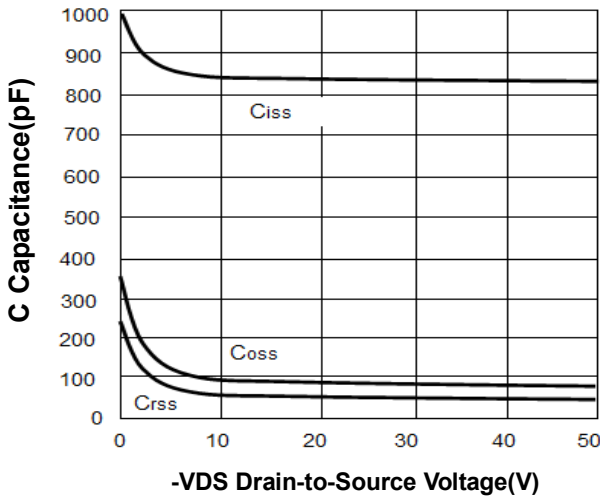

Figure6. $R_{DS(ON)}$ vs Junction Temperature

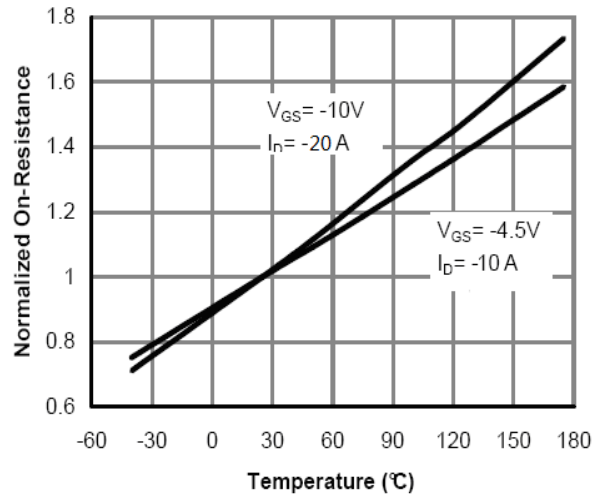

Figure7. $V_{GS(th)}$ vs Junction Temperature

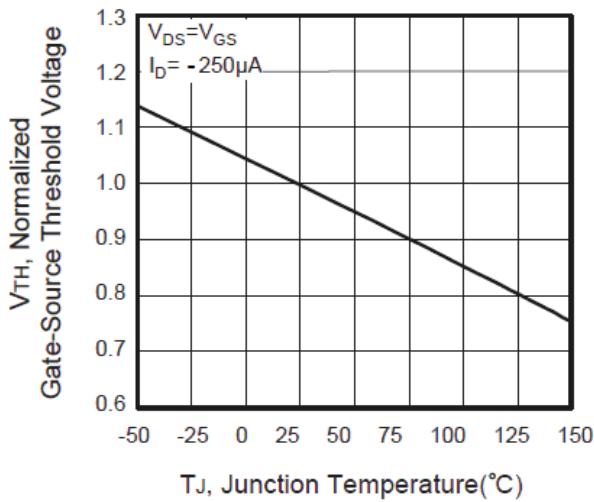

Figure8. Gate Charge Waveforms

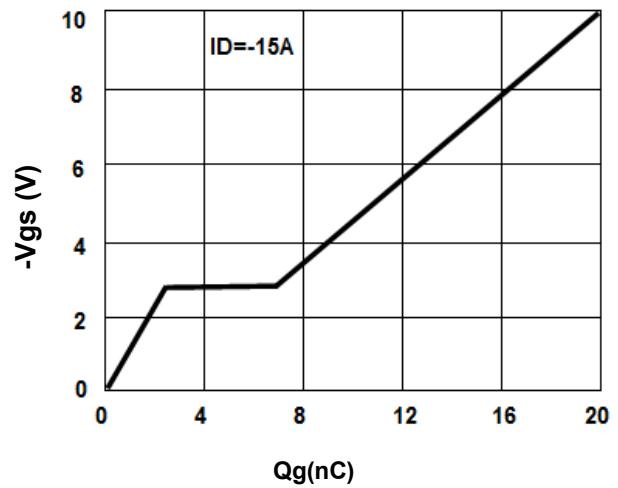
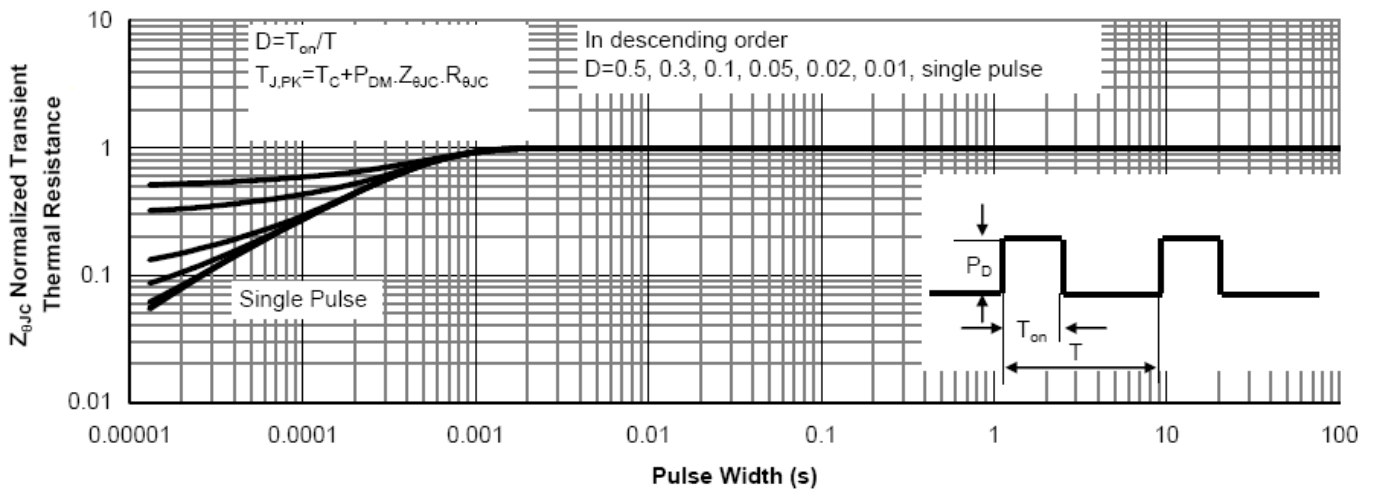
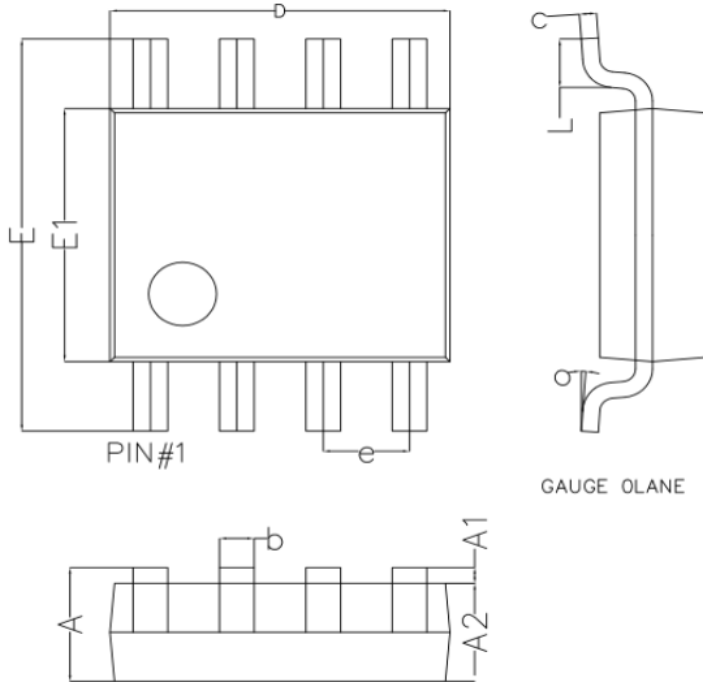

Figure9. Normalized Maximum Transient Thermal Impedance



SOP8 Package outline



Symbol	Dim in mm		
	Min	Nor	Max
A	1.350	1.550	1.750
A1	0.100	0.175	0.250
A2	1.350	1.450	1.550
b	0.330	0.420	0.510
c	0.170	0.210	0.250
D	4.800	4.900	5.000
e	1.270 (BSC)		
E	5.800	6.000	6.200
E1	3.800	3.900	4.000
L	0.400	0.835	1.2700
o	0°	4°	8°

Marking

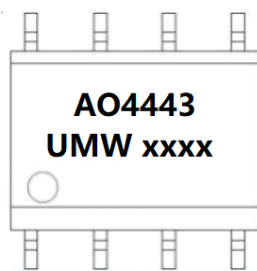

("xxxx"代表年份周期)

Ordering information

Order code	Package	Baseqty	Deliverymode
UMW AO4443	SOP-8	3000	Tape and reel