

Features

- Ultra High Efficiency (Up to 94.5%)
- Full Power at Wide Output Current Range (Constant Power)
- 0-10V/PWM/Timer Dimmable (3 Timer Modes)
- Dim-to-Off with Standby Power $\leq 1.5W$
- Output Lumen Compensation
- Input Surge Protection: 4kV line-line, 6kV line-earth
- All-Around Protection: OVP, SCP, OTP
- Waterproof (IP67) and UL Dry / Damp / Wet Location
- SELV Output
- TYPE HL, for use in a Class I, Division 2 hazardous (Classified) location
- 5 Years Warranty



Description

The ESD-320SxxxDT series is a 320W, constant-current, programmable LED driver that operates from 249-528 Vac input with excellent power factor. Created for many lighting applications including high bay, high mast, sports and roadway, it provides a dim-to-off mode with low standby power. The high efficiency of these drivers and compact metal case enables them to run cooler, significantly improving reliability and extending product life. To ensure trouble-free operation, protection is provided against input surge, output over voltage, short circuit, and over temperature.

Models

Adjustable Output Current Range	Full-Power Current Range (1)	Default Output Current	Input Voltage Range(2)	Output Voltage Range	Max. Output Power	Typical Efficiency (3)	Power Factor		Model Number
							277Vac	480Vac	
105-1500mA	1050-1500mA	1400 mA	249~528Vac 352~500Vdc	107~305Vdc	320 W	94.0%	0.96	0.95	ESD-320S150DT
154-2200mA	1540-2200mA	2100 mA	249~528Vac 352~500Vdc	73~208Vdc	320 W	94.5%	0.96	0.95	ESD-320S220DT
217-3100mA	2170-3100mA	2800 mA	249~528Vac 352~500Vdc	52~148Vdc	320 W	94.0%	0.96	0.95	ESD-320S310DT
308-4400mA	3080-4400mA	4200 mA	249~528Vac 352~500Vdc	37~104Vdc	320 W	94.0%	0.96	0.95	ESD-320S440DT
434-6200mA	4340-6200mA	4900 mA	249~528Vac 352~500Vdc	26 ~74Vdc	320 W	93.5%	0.96	0.95	ESD-320S620DT ⁽⁴⁾

- Notes:** (1) Output current range with constant power at 320W
 (2) Certified voltage range: 277-480Vac or 352-500Vdc
 (3) Measured at 100% load and 480Vac input (see below "General Specifications" for details).
 (4) SELV Output

I-V Operating Area

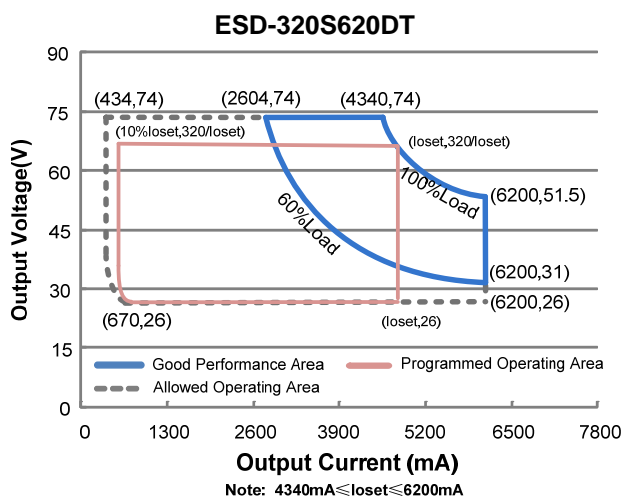
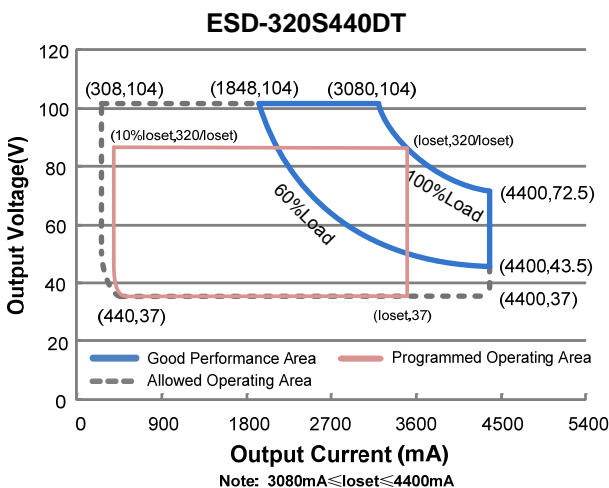
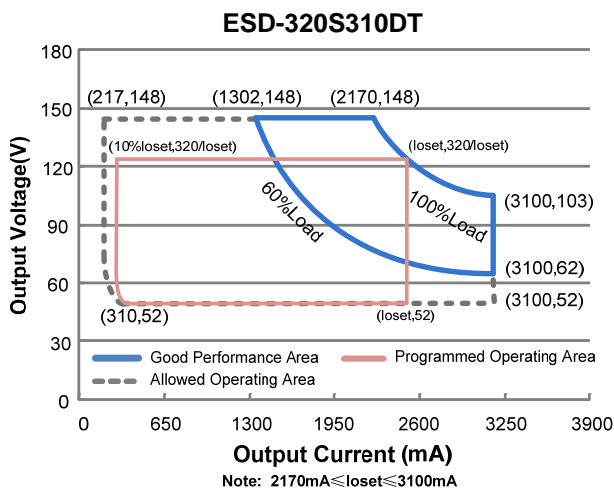
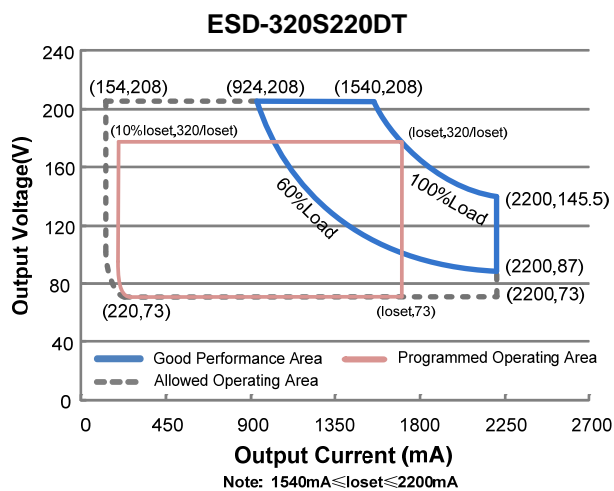
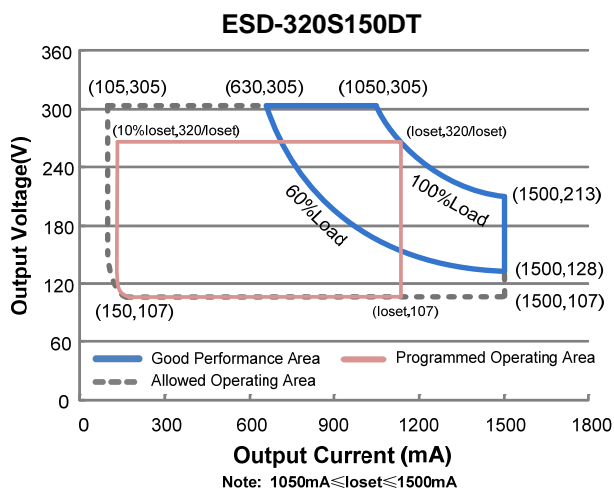

Input Specifications

Parameter	Min.	Typ.	Max.	Notes
Input Voltage	249 Vac	-	528 Vac	352-500Vdc
Input Frequency	47 Hz	-	63 Hz	
Leakage Current	-	-	0.75 MIU	UL8750; 480Vac/ 60Hz; Grounding effectively.
	-	-	0.70 mA	IIEC60598-1; 480Vac/ 60Hz; Grounding effectively.
Input AC Current	-	-	1.5 A	Measured at 100% load and 277 Vac input.
	-	-	0.8 A	Measured at 100% load and 480 Vac input.
Inrush Current(I ² t)	-	-	3.87 A ² s	At 480Vac input, 25°C Cold Start, Duration=1.77 ms, 10%Ipk-10%Ipk. See Inrush Current Waveform for the details.
PF	0.90	-	-	At 277-480Vac, 50-60Hz, 60%-100% Load (192-320W)
THD	-	-	20%	

Output Specifications

Parameter	Min.	Typ.	Max.	Notes
Output Current Tolerance	-5%loset	-	5%loset	100% load
Output Current Setting(loset) Range				
ESD-320S150DT	105 mA	-	1500 mA	
ESD-320S220DT	154 mA	-	2200 mA	
ESD-320S310DT	217 mA	-	3100 mA	
ESD-320S440DT	308 mA	-	4400 mA	
ESD-320S620DT	434 mA	-	6200 mA	
Output Current Setting Range with Constant Power				
ESD-320S150DT	1050 mA	-	1500 mA	
ESD-320S220DT	1540 mA	-	2200 mA	
ESD-320S310DT	2170 mA	-	3100 mA	
ESD-320S440DT	3080 mA	-	4400 mA	
ESD-320S620DT	4340 mA	-	6200 mA	
Total Output Current Ripple (pk-pk)	-	5%Iomax	10%Iomax	100% load, 20 MHz BW
Output Current Ripple at < 200 Hz (pk-pk)	-	2%Iomax	-	100% load. Only this component of ripple is associated with visible flicker.
Startup Overshoot Current	-	-	10%Iomax	100% load
No Load Output Voltage				
ESD-320S150DT	-	-	329V	
ESD-320S220DT	-	-	223V	
ESD-320S310DT	-	-	158V	
ESD-320S440DT	-	-	121V	
ESD-320S620DT	-	-	84V	

Output Specifications (Continued)

Parameter	Min.	Typ.	Max.	Notes
Line Regulation	-	-	±0.5%	Measured at 100% load
Load Regulation	-	-	±1.5%	
Turn-on Delay Time	-	0.5 s	0.75 s	Measured at 277Vac and 480Vac input, 60%-100% Load
Temperature Coefficient of I_{oSet}	-	0.03%/°C	-	Case temperature = 0°C ~Tc max
12V Auxiliary Output Voltage	10.8 V	12 V	13.2 V	
12V Auxiliary Output Source Current	0 mA	-	200 mA	Return terminal is "Dim"

Note: All specifications are typical at 25°C unless otherwise stated.

General Specifications

Parameter	Min.	Typ.	Max.	Notes	
Efficiency at 277 Vac input:					
ESD-320S150DT					
$I_o=1050mA$	90.5%	92.5%	-		
$I_o=1500mA$	89.5%	91.5%	-		
ESD-320S220DT					
$I_o=1540mA$	91.0%	93.0%	-		
$I_o=2200mA$	90.0%	92.0%	-		
ESD-320S310DT					
$I_o=2170mA$	90.5%	92.5%	-	Measured at 100% load and steady-state temperature in 25°C ambient; (Efficiency will be about 2.0% lower if measured immediately after startup.)	
$I_o=3100mA$	90.0%	92.0%	-		
ESD-320S440DT					
$I_o=3080mA$	91.0%	93.0%	-		
$I_o=4400mA$	90.0%	92.0%	-		
ESD-320S620DT					
$I_o=4340mA$	90.5%	92.5%	-		
$I_o=6200mA$	89.5%	91.5%	-		
Efficiency at 347 Vac input:					
ESD-320S150DT					
$I_o=1050mA$	91.5%	93.5%	-		Measured at 100% load and steady-state temperature in 25°C ambient; (Efficiency will be about 2.0% lower if measured immediately after startup.)
$I_o=1500mA$	90.5%	92.5%	-		
ESD-320S220DT					
$I_o=1540mA$	92.0%	94.0%	-		
$I_o=2200mA$	91.0%	93.0%	-		
ESD-320S310DT					
$I_o=2170mA$	91.5%	93.5%	-		
$I_o=3100mA$	90.5%	92.5%	-		
ESD-320S440DT					
$I_o=3080mA$	91.5%	93.5%	-		
$I_o=4400mA$	90.5%	92.5%	-		
ESD-320S620DT					
$I_o=4340mA$	91.0%	93.0%	-		
$I_o=6200mA$	90.0%	92.0%	-		

General Specifications (Continued)

Parameter	Min.	Typ.	Max.	Notes	
Efficiency at 480 Vac input: ESD-320S150DT I _o =1050mA I _o =1500mA ESD-320S220DT I _o =1540mA I _o =2200mA ESD-320S310DT I _o =2170mA I _o =3100mA ESD-320S440DT I _o =3080mA I _o =4400mA ESD-320S620DT I _o =4340mA I _o =6200mA	92.0% 91.0% 92.5% 91.5% 92.0% 91.0% 92.0% 91.0% 91.5% 90.5%	94.0% 93.0% 94.5% 93.5% 94.0% 93.0% 94.0% 93.0% 93.5% 92.5%	- - - - - - - - - -	Measured at 100% load and steady-state temperature in 25°C ambient; (Efficiency will be about 2.0% lower if measured immediately after startup.)	
Standby power	-	-	1.5 W		Measured at 480Vac/50Hz; Dimming off
MTBF	-	200,000 Hours	-		Measured at 480Vac input, 80%Load and 25°C ambient temperature (MIL-HDBK-217F)
Lifetime	-	120,000 Hours	-		Measured at 480Vac input, 80%Load and 70°C case temperature; See lifetime vs. Tc curve for the details
Operating Case Temperature for Safety T _{c_s}	-40°C	-	+87°C		
Operating Case Temperature for Warranty T _{c_w}	-40°C	-	+75°C		Case temperature for 5 years warranty
Storage Temperature	-40°C	-	+85°C		Humidity: 5%RH to 100%RH
Dimensions Inches (L × W × H) Millimeters (L × W × H)	9.21 × 3.86 × 1.76 234 × 98 × 44.8				With mounting ear 10.28 × 3.86 × 1.76 261 × 98 × 44.8
Net Weight	-	1935g	-		

Note: All specifications are typical at 25°C unless otherwise stated.

Dimming Specifications

Parameter	Min.	Typ.	Max.	Notes	
Absolute Maximum Voltage on the V _{dim} (+) Pin	-20 V	-	20 V		
Source Current on V _{dim} (+)Pin	200 uA	300 uA	450 uA	V _{dim} (+) = 0 V	
Dimming Output Range	ESD-320S150DT ESD-320S220DT ESD-320S310DT ESD-320S440DT ESD-320S620DT	10%I _o set	-	I _o set	1050mA ≤ I _o set ≤ 1500mA 1540mA ≤ I _o set ≤ 2200mA 2170mA ≤ I _o set ≤ 3100mA 3080mA ≤ I _o set ≤ 4400mA 4340mA ≤ I _o set ≤ 6200mA
	ESD-320S150DT ESD-320S220DT ESD-320S310DT ESD-320S440DT ESD-320S620DT	105 mA 154 mA 217 mA 308 mA 434 mA	-	I _o set	105mA ≤ I _o set < 1050mA 154mA ≤ I _o set < 1540mA 217mA ≤ I _o set < 2170mA 308mA ≤ I _o set < 3080mA 434mA ≤ I _o set < 4340mA

Dimming Specifications (Continued)

Parameter	Min.	Typ.	Max.	Notes
Recommended Dimming Input Range	0 V	-	10 V	Default 0-10V dimming mode.
Dim off Voltage	0.4 V	0.55V	0.7 V	
Dim on Voltage	0.6 V	0.75 V	0.9 V	
Hysteresis	-	0.2 V	-	
PWM_in High Level	3 V	-	10 V	Dimming mode set to PWM in PC interface.
PWM_in Low Level	-0.3 V	-	0.6 V	
PWM_in Frequency Range	200 Hz	-	3 KHz	
PWM_in Duty Cycle	1%	-	99%	
PWM Dimming off (Positive Logic)	3%	5%	8%	
PWM Dimming on (Positive Logic)	5%	7%	10%	
PWM Dimming off (Negative Logic)	92%	95%	97%	
PWM Dimming on (Negative Logic)	90%	93%	95%	
Hysteresis	-	2%	-	

Note: All specifications are typical at 25 °C unless stated otherwise.

Safety & EMC Compliance

Safety Category	Standard
UL/CUL	UL8750,CAN/CSA-C22.2 No. 250.13
CE	EN 61347-1, EN61347-2-13
EAC	IEC 61347-1, IEC 61347-2-13
EMI Standards	Notes
EN 55015 ⁽¹⁾	Conducted emission Test & Radiated emission Test
EN 61000-3-2	Harmonic current emissions
EN 61000-3-3	Voltage fluctuations & flicker
FCC Part15 ⁽¹⁾	ANSI C63.4 Class B
	This device complies with Part 15 of the FCC Rules. Operation is subject to the following two conditions: [1] this device may not cause harmful interference, and [2] this device must accept any interference received, including interference that may cause undesired operation.
EMS Standards	Notes
EN 61000-4-2	Electrostatic Discharge (ESD): 8 kV air discharge, 4 kV contact discharge
EN 61000-4-3	Radio-Frequency Electromagnetic Field Susceptibility Test-RS

Safety & EMC Compliance (Continued)

EMS Standards	Notes
EN 61000-4-4	Electrical Fast Transient / Burst-EFT
EN 61000-4-5	Surge Immunity Test: AC Power Line: line to line 4 kV, line to earth 6 kV ⁽²⁾
EN 61000-4-6	Conducted Radio Frequency Disturbances Test-CS
EN 61000-4-8	Power Frequency Magnetic Field Test
EN 61000-4-11	Voltage Dips
EN 61547	Electromagnetic Immunity Requirements Applies To Lighting Equipment

- Note:** (1) This LED driver meets the EMI specifications above, but EMI performance of a luminaire that contains it depends also on the other devices connected to the driver and on the fixture itself.
- (2) To perform electric strength (hi-pot) testing, the “GDT ground disconnect” (nut and metal lock sheet) on the driver end-cap should be removed temporarily to prevent the internal gas discharge tube from conducting (as allowed by IEC 60598-1 Clause 10.2). After testing is completed, these items must be reinstalled to restore line-to-earth surge protection and secure the end cap.

Lifetime vs. Case Temperature

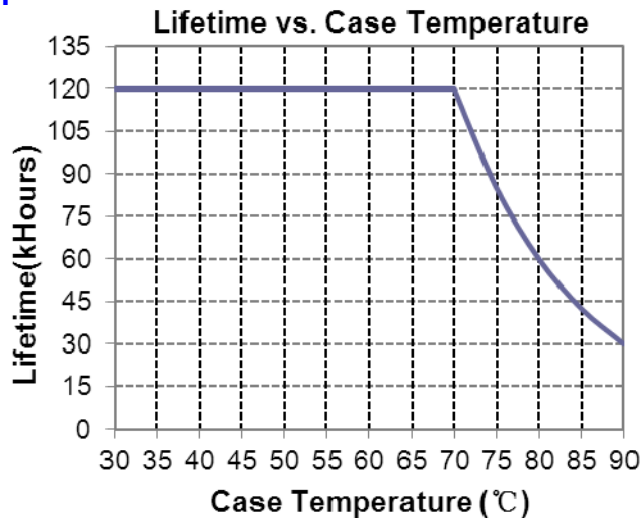

Inrush Current Waveform

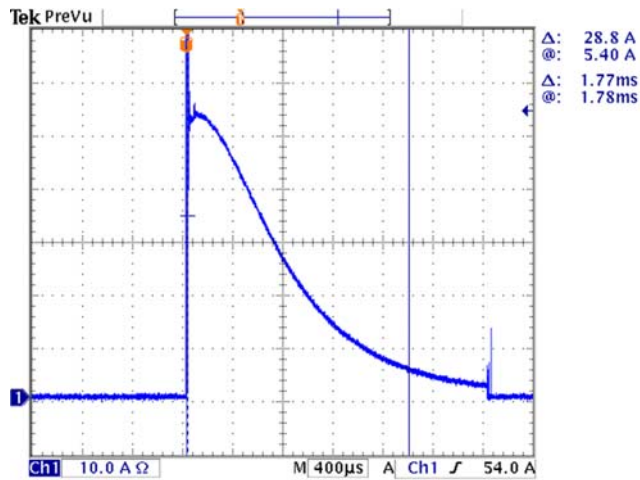

Efficiency vs. Load

ESD-320S150DT (I_o=1050mA)
Efficiency vs. Output Voltage

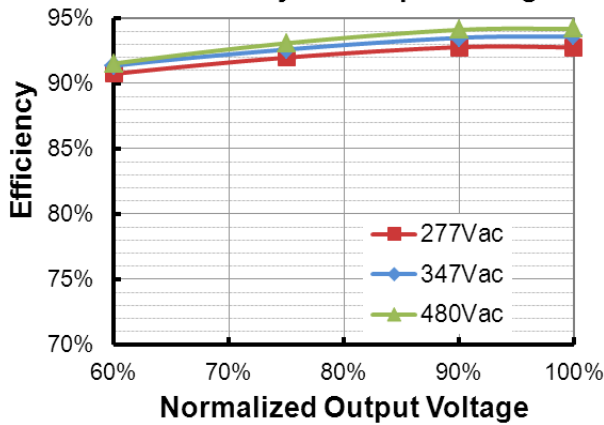

ESD-320S150DT (I_o=1500mA)
Efficiency vs. Output Voltage

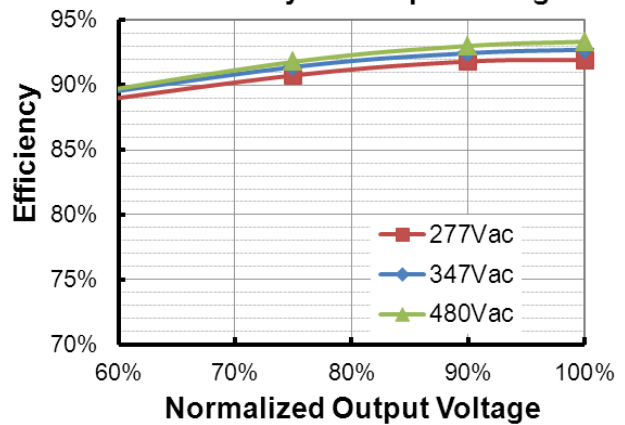

ESD-320S220DT (I_o=1540mA)
Efficiency vs. Output Voltage

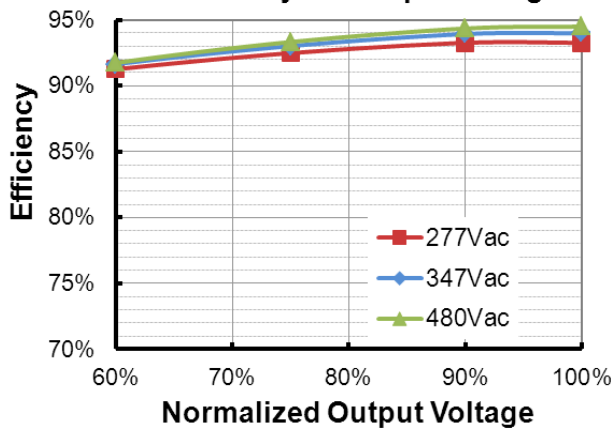

ESD-320S220DT (I_o=2200mA)
Efficiency vs. Output Voltage

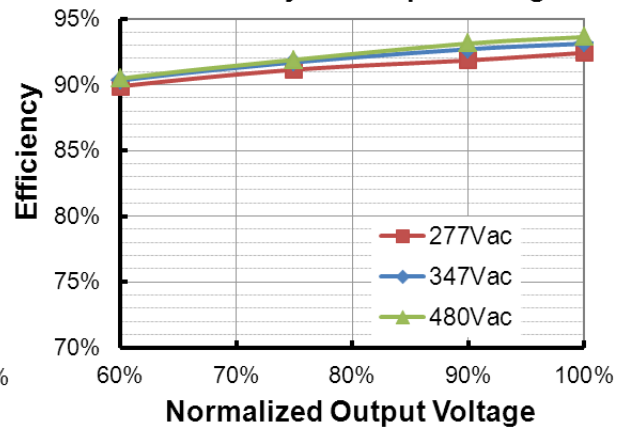

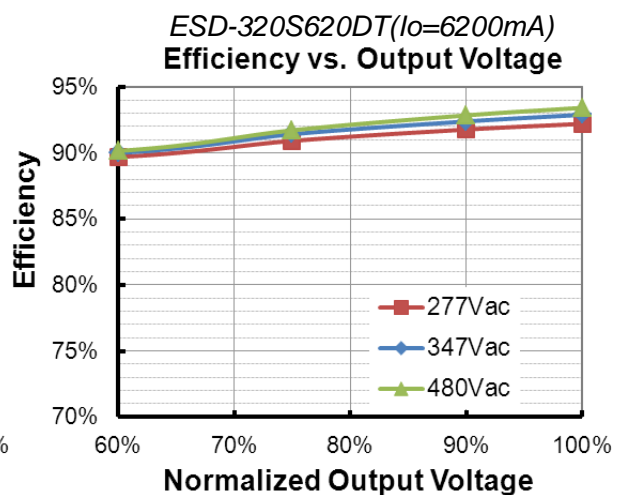
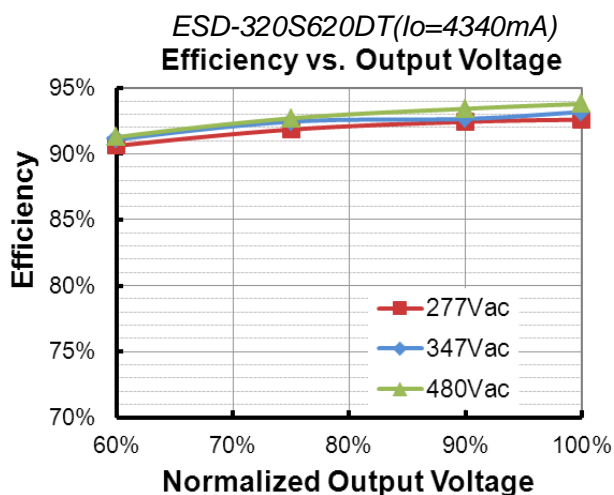
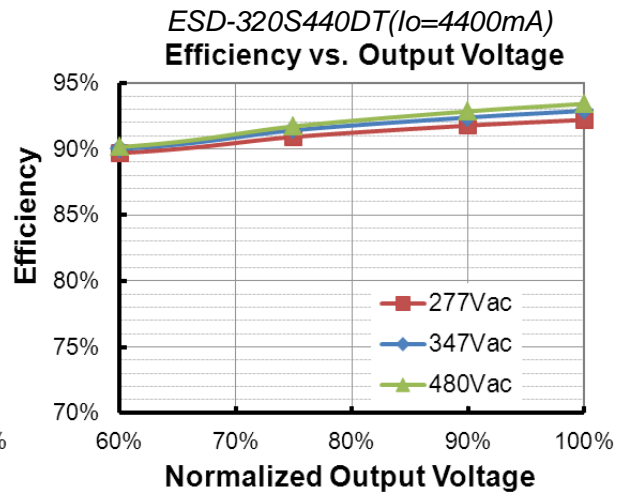
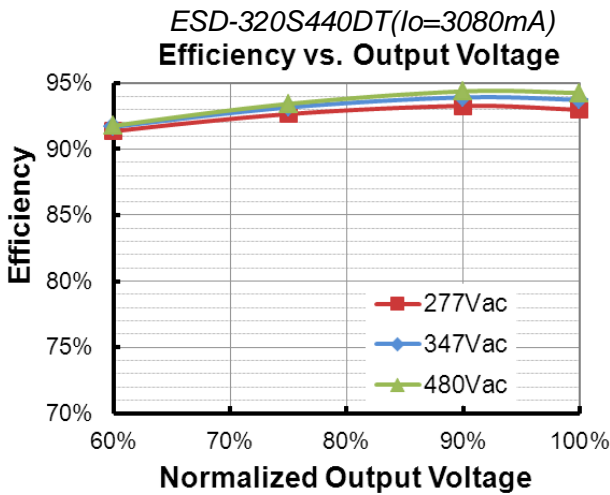
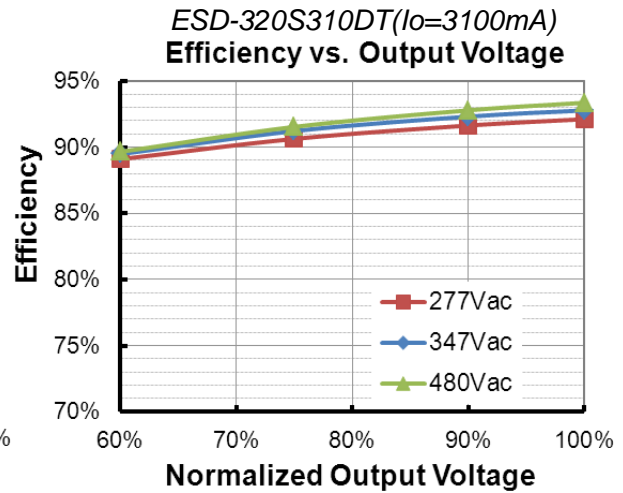
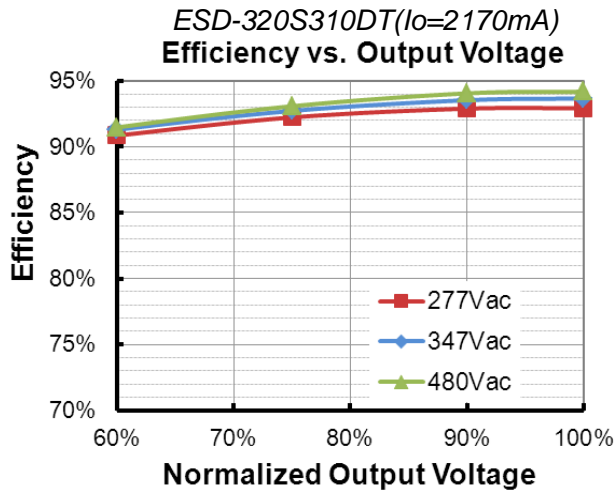

Power Factor

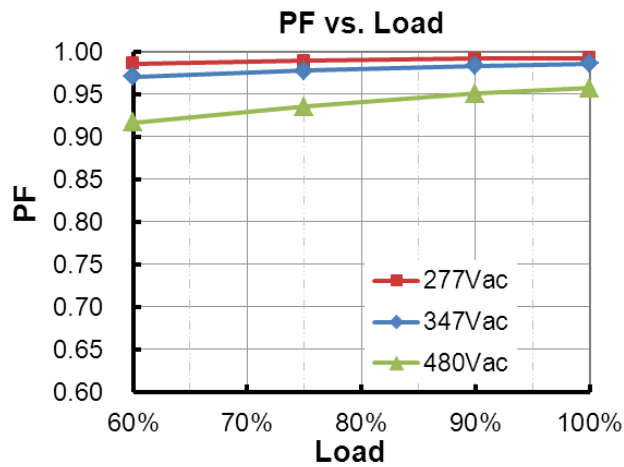

Total Harmonic Distortion

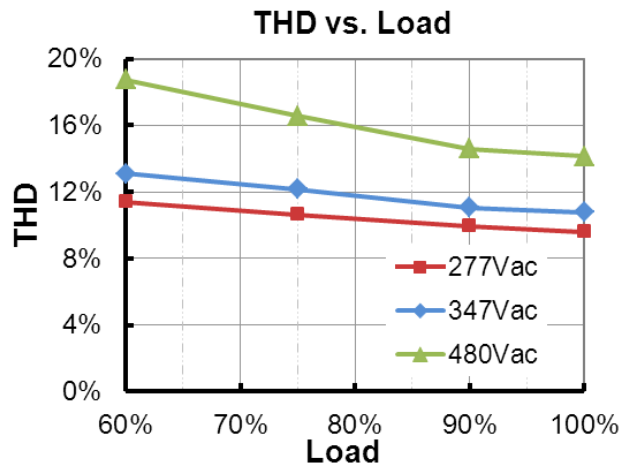

Protection Functions

Parameter	Notes
Over Temperature Protection	Decreases output current, returning to normal after over temperature is removed.
Short Circuit Protection	Auto Recovery. No damage will occur when any output is short circuited. The output shall return to normal when the fault condition is removed.
Over Voltage Protection	Limits output voltage at no load and in case the normal voltage limit fails.

Dimming

● 0-10V Dimming

The recommended implementation of the dimming control is provided below.

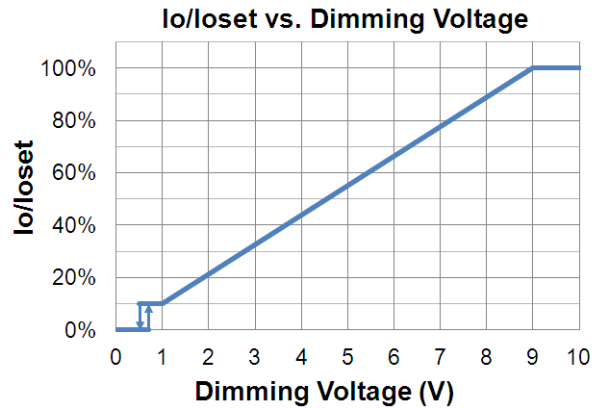
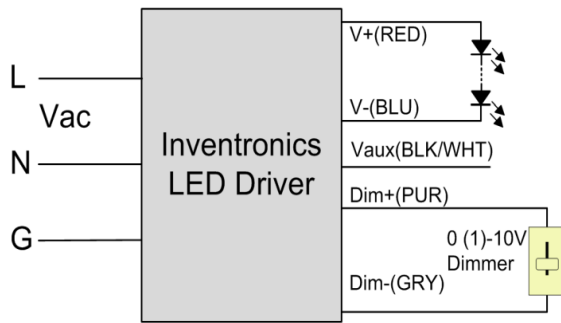

Implementation 1: DC Input

Notes:

1. The dimmer can also be replaced by an active 0-10V voltage source signal or passive components like resistors and zener.
2. Do NOT connect Dim- to the output V- or V+, otherwise the driver will not work properly.
3. If 0-10V dimming is not used, Dim + should be open.

● **PWM Dimming**

The recommended implementation of the dimming control is provided below.

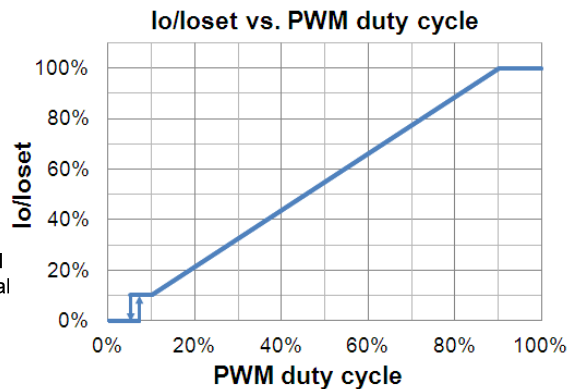
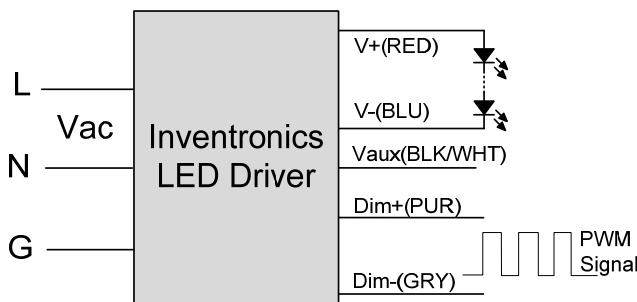

Implementation 2: Positive logic

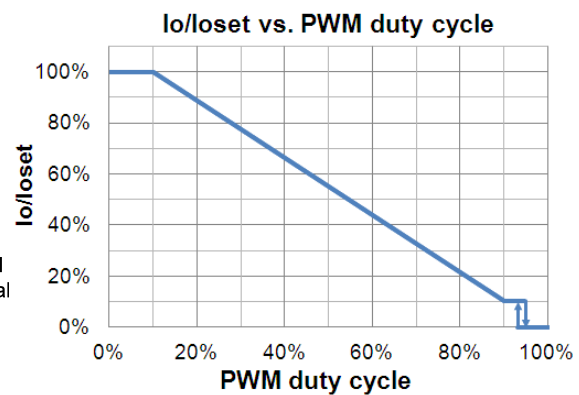
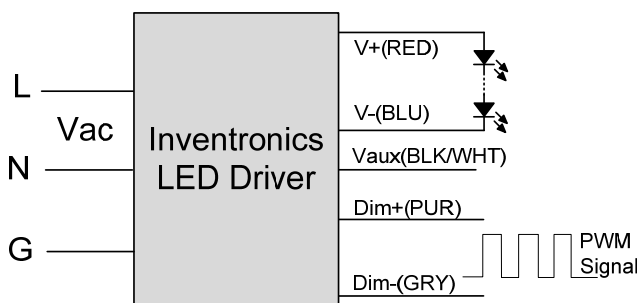

Implementation 3: Negative logic

Notes:

1. Do NOT connect Dim- to the output V- or V+, otherwise the driver will not work properly.

2. If PWM dimming is not used, Dim + should be open.
3. When PWM negative logic dimming mode and Dim+ is open, the driver will output minimum current.

● Time Dimming

Time dimming control includes 3 kinds of modes, they are Self Adapting-Midnight, Self Adapting-Percentage and Traditional Timer.

- **Self Adapting-Midnight:** Automatically adjusts the dimming curve based on the on-time of past two days (if difference <15 minutes), assuming that the center point of the dimming curve is midnight local time.
- **Self Adapting-Percentage:** Automatically adjusts the on-time of each step by a constant percentage = (actual on-time for the past 2 days if difference <15 min) / (programmed on-time from the dimming curve).
- **Traditional Timer:** Follows the programmed timing curve after power on with no changes.

● Output Lumen Compensation

Output Lumen Compensation (OLC) may be used to maintain constant light output over the life of the LEDs by driving them at a reduced current when new, then gradually increasing the drive current over time to counteract LED lumen degradation.

Programming Connection Diagram

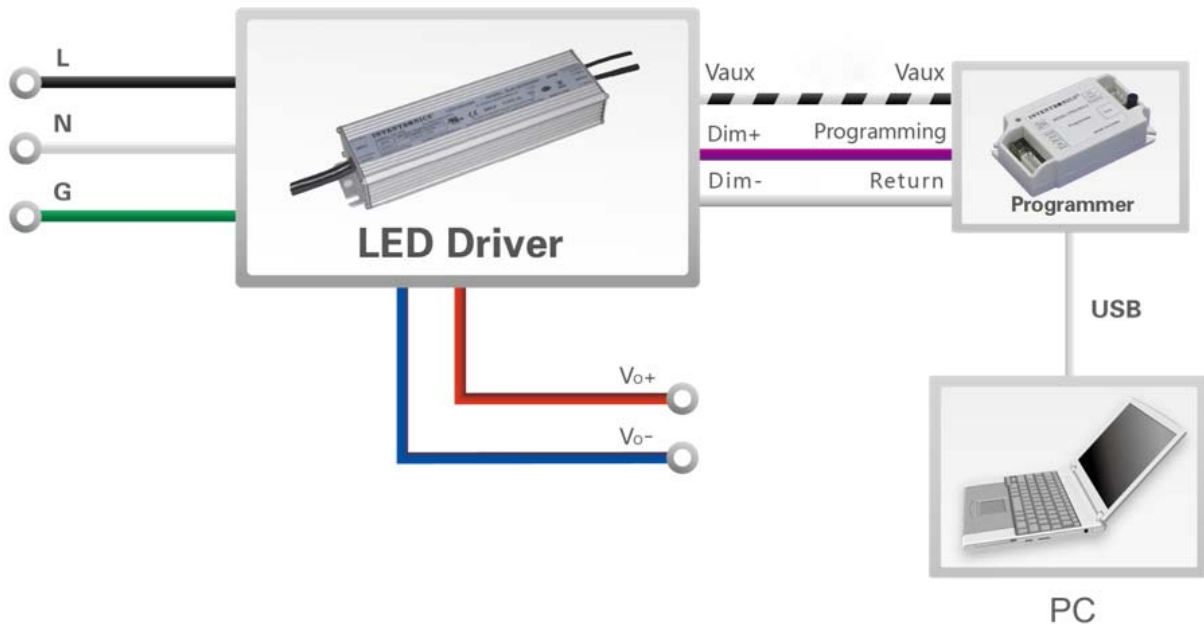

Note: The driver does not need to be powered on during the programming process.

- Please refer to [PRG-MUL2](#) (Programmer) datasheet for details.

Mechanical Outline

ESD-320S150DT

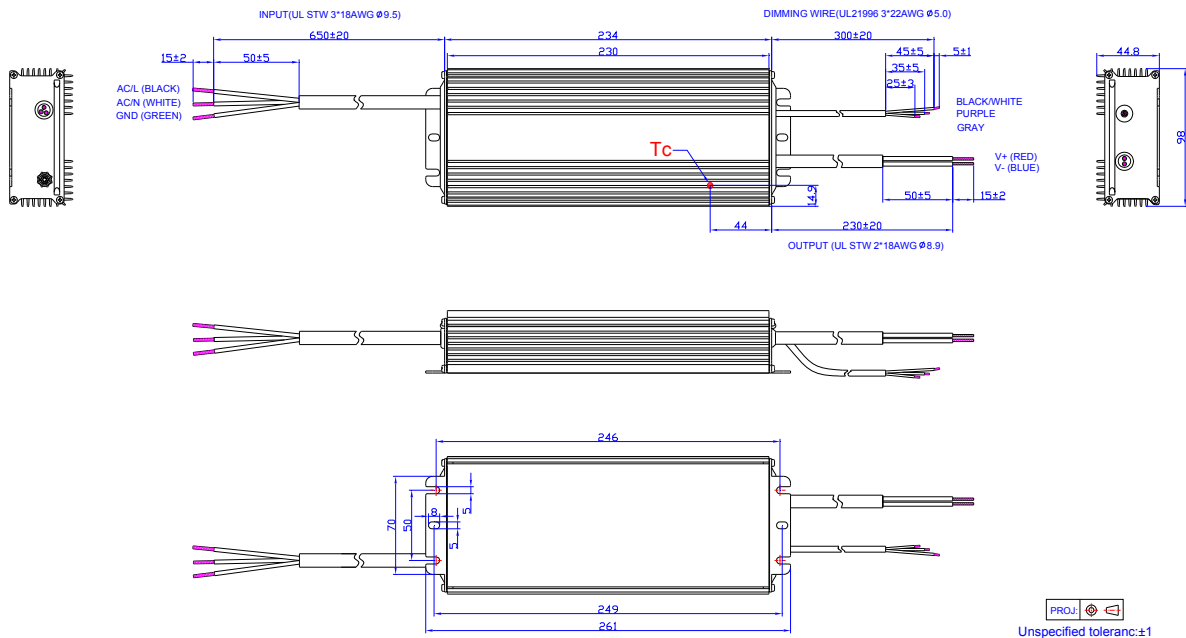

Other Models

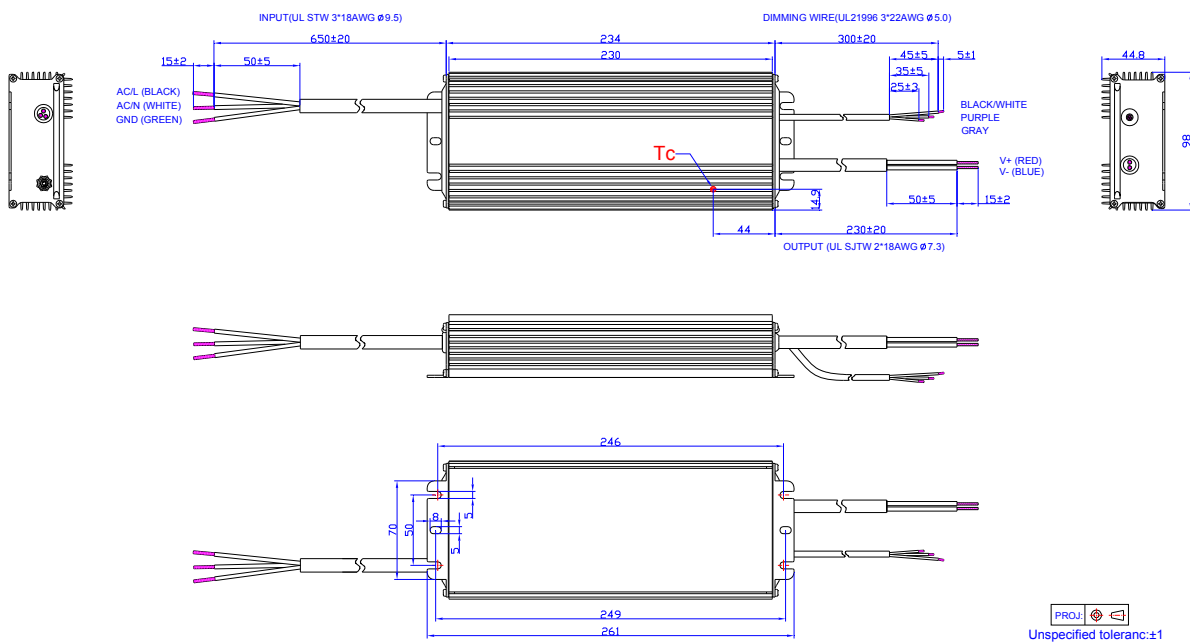

RoHS Compliance

Our products comply with the European Directive 2011/65/EC, calling for the elimination of lead and other hazardous substances from electronic products.

Revision History

Change Date	Rev.	Description of Change		
		Item	From	To
2015-01-14	A	Datasheets Release	/	/
2015-03-09	B	Features	Input Surge Protection: 4kV line-line, 6kV line-earth	Added
		Model: ESD-320S150DT	/	Added
		Output Current Ripple(pk-pk)	Output Current Ripple(pk-pk)	Total Output Current Ripple (pk-pk)
		Output Current Ripple at < 200 Hz (pk-pk)	/	Added
		Operating Case Temperature for Safety Tc_s	/	Updated
		Operating Case Temperature for Warranty Tc_w	/	Updated
		General Specifications	Storage Temperature	Added
		Environmental Specifications	/	Delete
2016-01-28	C	Features	/	Updated
		General Specifications	Net Weight	Updated
		Lifetime vs. Case Temperature	/	Updated
		Time Dimming	/	Updated
		Output Lumen Compensation	/	Added
		Programming Connection Diagram	/	Updated
2017-08-03	D	Input Specifications	PF/THD	Updated
		Output Specifications	Turn-on Delay Time	Updated
		Output Specifications	Temperature Coefficient of I _o set	Updated
		General Specifications	With mounting ear	Added
		Safety & EMC Compliance	/	Updated
		Mechanical Outline	/	Updated
2017-11-23	E	Features	5 Years Warranty	Updated
		Output Specifications	Turn-on Delay Time	Updated
		General Specifications	Lifetime	Updated
		General Specifications	Operating Case Temperature for Warranty Tc_w	Updated
		Lifetime vs. Case Temperature	/	Updated

Revision History (Continued)

Change Date	Rev.	Description of Change		
		Item	From	To
2018-11-28	F	CE	/	Added
		Features	/	Updated
		Models	/	Updated
		I-V Operating Area	/	Updated
		Input Specifications	Leakage Current	Updated
		Output Specifications	Output Current Setting(losct) Range	Updated
		Output Specifications	Output Current Setting Range with Constant Power	Updated
		Output Specifications	Turn-on Delay Time	Updated
		General Specifications	Dimensions	Updated
		General Specifications	Net Weight	Updated
		Dimming Specifications	Dimming Output Range	Updated
		Safety & EMC Compliance	/	Updated
		Programming Connection Diagram	/	Updated
		Mechanical Outline	/	Updated
2019-02-27	G	EAC	/	Added
		Safety & EMC Compliance	/	Updated
		Efficiency vs. Load	ESD-320S660DT	ESD-320S620DT