

# Cylindrical Proximity Sensor E2E/E2E2

## A New Series of Easy-to-use and Tough E2E/E2E2 Models Long-size E2E2 Proximity Sensor Conforms to CENELEC

- Ideal for a variety of applications.
- With a metal connector that can be tightened securely and a cable protector.
- With an easy-to-see indicator, deeper mounting holes, and tightening flats for wrenches.
- New 3-dia. size (sensing distance: 0.6 mm) added to the lineup.







### <READ AND UNDERSTAND THIS CATALOG>

Please read and understand this catalog before purchasing the products. Please consult your OMRON representative if you have any questions or comments.

## Ordering Information

### E2E

#### DC 2-wire/Pre-wired Models






Self-diagnostic output function	Size		Sensing distance	Model	
				NO	NC
Yes	Shielded 	M12	3 mm	E2E-X3D1S (See note 1.)	---
		M18	7 mm	E2E-X7D1S (See note 1.)	---
		M30	10 mm	E2E-X10D1S (See note 1.)	---
	Unshielded 	M12	8 mm	E2E-X8MD1S (See note 1.)	---
		M18	14 mm	E2E-X14MD1S (See note 1.)	---
		M30	20 mm	E2E-X20MD1S (See note 1.)	---
No	Shielded 	M8	2 mm	E2E-X2D1-N (See notes 2 and 3.)	E2E-X2D2-N (See note 3.)
		M12	3 mm	E2E-X3D1-N (See notes 1, 2 and 3.)	E2E-X3D2-N (See note 3.)
		M18	7 mm	E2E-X7D1-N (See notes 1, 2 and 3.)	E2E-X7D2-N (See note 3.)
		M30	10 mm	E2E-X10D1-N (See notes 1, 2 and 3.)	E2E-X10D2-N
	Unshielded 	M8	4 mm	E2E-X4MD1 (See notes 2 and 3.)	E2E-X4MD2
		M12	8 mm	E2E-X8MD1 (See notes 1, 2 and 3.)	E2E-X8MD2
		M18	14 mm	E2E-X14MD1 (See notes 1, 2 and 3.)	E2E-X14MD2
		M30	20 mm	E2E-X20MD1 (See notes 1, 2 and 3.)	E2E-X20MD2

**Note 1.** In addition to the above models, E2E-X□□15 models (e.g., E2E-X3D15-N), which are different in frequency from the above models, are available.

**2.** E2E models with a robotics cable are available as well. The model number of a model with a robotics cable has the suffix “-R” (e.g., E2E-X3D1-R).



**3.** Cables with a length of 5 m are also available. Specify the cable length at the end of the model number (e.g., E2E-X3D1-N 5M).

## DC 2-wire/Connector Models

Connector	Self-diagnostic output function	Size	Sensing distance	Model		
				NO	NC	
M12	Yes	Shielded 	M12	3 mm	E2E-X3D1S-M1	---
			M18	7 mm	E2E-X7D1S-M1	---
			M30	10 mm	E2E-X10D1S-M1	---
		Unshielded 	M12	8 mm	E2E-X8MD1S-M1	---
			M18	14 mm	E2E-X14MD1S-M1	---
			M30	20 mm	E2E-X20MD1S-M1	---
	No	Shielded 	M8	2 mm	E2E-X2D1-M1G	E2E-X2D2-M1G
			M12	3 mm	E2E-X3D1-M1G (See note.)	E2E-X3D2-M1G
			M18	7 mm	E2E-X7D1-M1G (See note.)	E2E-X7D2-M1G
			M30	10 mm	E2E-X10D1-M1G (See note.)	E2E-X10D2-M1G
		Unshielded 	M8	4 mm	E2E-X4MD1-M1G	E2E-X4MD2-M1G
			M12	8 mm	E2E-X8MD1-M1G (See note.)	E2E-X8MD2-M1G
			M18	14 mm	E2E-X14MD1-M1G (See note.)	E2E-X14MD2-M1G
			M30	20 mm	E2E-X20MD1-M1G (See note.)	E2E-X20MD2-M1G
M8	Shielded 	M8	2 mm	E2E-X2D1-M3G	E2E-X2D2-M3G	
			4 mm	E2E-X4MD1-M3G	E2E-X4MD2-M3G	

**Note:** In addition to the above models, E2E-X□D15-M1G models (e.g., E2E-X3D15-M1G), which are different in frequency from the above models, are available.

## DC 2-wire/Pre-wired Connector Models

Size	Sensing distance	Operation mode	Polarity	Model
Shielded 	M12	NO	Yes	E2E-X3D1-M1GJ
			No	E2E-X3D1-M1J-T
	M18		Yes	E2E-X7D1-M1GJ
			No	E2E-X7D1-M1J-T
	M30		Yes	E2E-X10D1-M1GJ
			No	E2E-X10D1-M1J-T
Unshielded 	M12	Yes	E2E-X8MD1-M1GJ	
	M18	E2E-X14MD1-M1GJ		
	M30	E2E-X20MD1-M1GJ		



**Note 1.** A model with no polarity has a residual voltage of 5 V, which must be taken into consideration together with the interface condition (the PLC's ON voltage, for example) when connecting the Proximity Sensor to a load.

**2.** The standard cable length is 300 mm. Models are also available with 500 mm and 1 m cables.


## Connector Pin Assignments of DC 2-wire Model


The connector pin assignments of each new E2E DC 2-wire conforms to IEC947-5-2 Table III.

The following E2E models with conventional connector pin assignments are available as well.

Size	Operation mode	Model	Size	Operation mode	Model
Shielded 	M8	NO	Unshielded 	M8	NO
		NC			NC
	M12	NO		M12	NO
		NC			NC
	M18	NO		M18	NO
		NC			NC
	M30	NO		M30	NO
		NC			NC



DC 3-wire/Pre-wired Models

Size		Sensing distance	Output configuration	Model
Shielded 	3 dia.	0.6 mm	NPN NO	E2E-CR6C1
			NPN NC	E2E-CR6C2
			PNP NO	E2E-CR6B1
			PNP NC	E2E-CR6B2
	4 dia.	0.8 mm	NPN NO	E2E-CR8C1 (See notes 1 and 2.)
			NPN NC	E2E-CR8C2
			PNP NO	E2E-CR8B1
			PNP NC	E2E-CR8B2
	M5	1 mm	NPN NO	E2E-X1C1 (See notes 1 and 2.)
			NPN NC	E2E-X1C2
			PNP NO	E2E-X1B1
			PNP NC	E2E-X1B2
	5.4 dia.	1 mm	NPN NO	E2E-C1C1 (See notes 1 and 2.)
			NPN NC	E2E-C1C2
			PNP NO	E2E-C1B1
			PNP NC	E2E-C1B2
	M8	1.5 mm	NPN NO	E2E-X1R5E1 (See notes 1 and 2.)
			NPN NC	E2E-X1R5E2
			PNP NO	E2E-X1R5F1
			PNP NC	E2E-X1R5F2
	M12	2 mm	NPN NO	E2E-X2E1 (See notes 1, 2, 3, and 4.)
			NPN NC	E2E-X2E2 (See notes 3 and 4.)
			PNP NO	E2E-X2F1
			PNP NC	E2E-X2F2
M18	5 mm	NPN NO	E2E-X5E1 (See notes 1, 2, 3, and 4.)	
		NPN NC	E2E-X5E2 (See notes 3 and 4.)	
		PNP NO	E2E-X5F1	
		PNP NC	E2E-X5F2	
M30	10 mm	NPN NO	E2E-X10E1 (See notes 1, 2, 3, and 4.)	
		NPN NC	E2E-X10E2 (See notes 3 and 4.)	
		PNP NO	E2E-X10F1	
		PNP NC	E2E-X10F2	

Size		Sensing distance	Output configuration	Model
Un-shielded 	M8	2 mm	NPN NO	E2E-X2ME1 (See note 2.)
			NPN NC	E2E-X2ME2
			PNP NO	E2E-X2MF1
			PNP NC	E2E-X2MF2
	M12	5 mm	NPN NO	E2E-X5ME1 (See notes 1, 2, 3, and 4.)
			NPN NC	E2E-X5ME2 (See notes 3 and 4.)
			PNP NO	E2E-X5MF1
			PNP NC	E2E-X5MF2
	M18	10 mm	NPN NO	E2E-X10ME1 (See notes 1, 2, 3, and 4.)
			NPN NC	E2E-X10ME2 (See notes 3 and 4.)
			PNP NO	E2E-X10MF1
			PNP NC	E2E-X10MF2
	M30	18 mm	NPN NO	E2E-X18ME1 (See notes 1, 2, 3, and 4.)
			NPN NC	E2E-X18ME2 (See notes 3 and 4.)
			PNP NO	E2E-X18MF1
			PNP NC	E2E-X18MF2






- Note 1.** Cables with a length of 5 m are also available. Specify the cable length at the end of the model number (e.g., E2E-X2E1 5M).
- 2.** Models with a robotics cable are also available. These models are E2E-X□E1-R (e.g., E2E-X5E1-R).
- 3.** Models with a different frequency are also available. These models are E2E-X□E□5 (e.g., E2E-X5E15).
- 4.** These models have e-CON connectors (0.3 m cable length), which is indicated by the suffix "ECON" (e.g., E2E-X2E1-ECON).

AC 2-wire/Pre-wired Models



Size		Sensing distance	Operation mode	Model	
Shielded 	M8	1.5 mm	NO	E2E-X1R5Y1	
			NC	E2E-X1R5Y2	
	M12	2 mm	NO	E2E-X2Y1 (See notes 1 and 2.)	
			NC	E2E-X2Y2	
	M18	5 mm	NO	E2E-X5Y1 (See notes 1 and 2.)	
			NC	E2E-X5Y2	
	M30	10 mm	NO	E2E-X10Y1 (See notes 1 and 2.)	
			NC	E2E-X10Y2	
	Un-shielded 	M8	2 mm	NO	E2E-X2MY1
				NC	E2E-X2MY2
		M12	5 mm	NO	E2E-X5MY1 (See notes 1 and 2.)
				NC	E2E-X5MY2
M18		10 mm	NO	E2E-X10MY1 (See note 1.)	
			NC	E2E-X10MY2	
M30		18 mm	NO	E2E-X18MY1 (See note 1.)	
			NC	E2E-X18MY2	

- Note 1.** Models with a different frequency are also available. These models are E2E-X□Y□5 (e.g., E2E-X5Y15).
- 2.** Cables with a length of 5 m are also available. Specify the cable length at the end of the model number (e.g., E2E-X2Y1 5M).


DC 3-wire/Connector Models

Connector	Size	Sensing distance	Output configuration	Model			
M12	Shielded 	M8	1.5 mm	NPN NO	E2E-X1R5E1-M1		
			NPN NC	E2E-X1R5E2-M1			
			PNP NO	E2E-X1R5F1-M1			
			PNP NC	E2E-X1R5F2-M1			
		M12	2 mm	NPN NO	E2E-X2E1-M1		
				NPN NC	E2E-X2E2-M1		
				PNP NO	E2E-X2F1-M1		
				PNP NC	E2E-X2F2-M1		
		M18	5 mm	NPN NO	E2E-X5E1-M1		
				NPN NC	E2E-X5E2-M1		
				PNP NO	E2E-X5F1-M1		
				PNP NC	E2E-X5F2-M1		
	M30	10 mm	NPN NO	E2E-X10E1-M1			
			NPN NC	E2E-X10E2-M1			
			PNP NO	E2E-X10F1-M1			
			PNP NC	E2E-X10F2-M1			
	Un-shielded 	M8	2 mm	NPN NO	E2E-X2ME1-M1		
				NPN NC	E2E-X2ME2-M1		
				PNP NO	E2E-X2MF1-M1		
				PNP NC	E2E-X2MF2-M1		
		M12	5 mm	NPN NO	E2E-X5ME1-M1		
				NPN NC	E2E-X5ME2-M1		
				PNP NO	E2E-X5MF1-M1		
				PNP NC	E2E-X5MF2-M1		
		M18	10 mm	NPN NO	E2E-X10ME1-M1		
				NPN NC	E2E-X10ME2-M1		
				PNP NO	E2E-X10MF1-M1		
				PNP NC	E2E-X10MF2-M1		
		M30	18 mm	NPN NO	E2E-X18ME1-M1		
				NPN NC	E2E-X18ME2-M1		
				PNP NO	E2E-X18MF1-M1		
				PNP NC	E2E-X18MF2-M1		
		M8-3 pin	Shielded 	4 dia.	0.8 mm	NPN NO	E2E-CR8C1-M5
						NPN NC	E2E-CR8C2-M5
						PNP NO	E2E-CR8B1-M5
						PNP NC	E2E-CR8B2-M5
M5			1 mm	NPN NO	E2E-X1C1-M5		
				NPN NC	E2E-X1C2-M5		
				PNP NO	E2E-X1B1-M5		
				PNP NC	E2E-X1B2-M5		
M8	Shielded 	M8	1.5 mm	NPN NO	E2E-X1R5E1-M3		
				NPN NC	E2E-X1R5E2-M3		
				PNP NO	E2E-X1R5F1-M3		
				PNP NC	E2E-X1R5F2-M3		
	Un-shielded 	M8	2 mm	NPN NO	E2E-X2ME1-M3		
				NPN NC	E2E-X2ME2-M3		
				PNP NO	E2E-X2MF1-M3		
				PNP NC	E2E-X2MF2-M3		

AC 2-wire/Connector Models

Size	Sensing distance	Operation mode	Model	
Shielded 	M12	2 mm	NO	E2E-X2Y1-M1
		NC	E2E-X2Y2-M1	
	M18	5 mm	NO	E2E-X5Y1-M1
			NC	E2E-X5Y2-M1
	M30	10 mm	NO	E2E-X10Y1-M1
			NC	E2E-X10Y2-M1
Un-shielded 	M12	5 mm	NO	E2E-X5MY1-M1
			NC	E2E-X5MY2-M1
	M18	10 mm	NO	E2E-X10MY1-M1
			NC	E2E-X10MY2-M1
	M30	18 mm	NO	E2E-X18MY1-M1
			NC	E2E-X18MY2-M1



AC/DC 2-wire/Pre-wired Models

Size	Sensing distance	Operation mode	Model	
Shielded 	M12	3 mm	NO	E2E-X3T1
	M18	7 mm		E2E-X7T1 (See note 2.)
	M30	10 mm		E2E-X10T1

- Note 1.** These models do not conform to CE standards.
- 2.** Cables with a length of 5 m are also available as standard models. Specify the cable length at the end of the model number (e.g., E2E-X7T1 5M).


**E2E2**

**DC 2-wire/Pre-wired Models**



Size	Sensing distance	Operation mode	Model
Shielded 	M12	3 mm	NO (See note.) E2E2-X3D1
		NC E2E2-X3D2	
	M18	7 mm	NO (See note.) E2E2-X7D1
			NC E2E2-X7D2
	M30	10 mm	NO (See note.) E2E2-X10D1
			NC E2E2-X10D2
Unshielded 	M12	8 mm	NO (See note.) E2E2-X8MD1
		NC E2E2-X8MD2	
	M18	14 mm	NO (See note.) E2E2-X14MD1
			NC E2E2-X14MD2
	M30	20 mm	NO (See note.) E2E2-X20MD1
			NC E2E2-X20MD2

**Note:** In addition to the above models, E2E-X□D15 models (e.g., E2E-X3D15), which are different in frequency from the above models, are available.



**DC 3-wire/Pre-wired Models**

Size	Sensing distance	Output configuration	Model
Shielded 	M12	2 mm	NPN NO E2E2-X2C1
		NPN NC E2E2-X2C2	
		PNP NO E2E2-X2B1	
		PNP NC E2E2-X2B2	
	M18	5 mm	NPN NO E2E2-X5C1
			NPN NC E2E2-X5C2
			PNP NO E2E2-X5B1
			PNP NC E2E2-X5B2
	M30	10 mm	NPN NO E2E2-X10C1
			NPN NC E2E2-X10C2
			PNP NO E2E2-X10B1
			PNP NC E2E2-X10B2
Unshielded 	M12	5 mm	NPN NO E2E2-X5MC1
		NPN NC E2E2-X5MC2	
		PNP NO E2E2-X5MB1	
		PNP NC E2E2-X5MB2	
	M18	10 mm	NPN NO E2E2-X10MC1
			NPN NC E2E2-X10MC2
			PNP NO E2E2-X10MB1
			PNP NC E2E2-X10MB2
	M30	18 mm	NPN NO E2E2-X18MC1
			NPN NC E2E2-X18MC2
			PNP NO E2E2-X18MB1
			PNP NC E2E2-X18MB2



**DC 3-wire/Connector Models**

Size		Sensing distance	Output configuration	Model
Shielded 	M12	2 mm	NPN NO	E2E2-X2C1-M1
			NPN NC	E2E2-X2C2-M1
			PNP NO	E2E2-X2B1-M1
			PNP NC	E2E2-X2B2-M1
	M18	5 mm	NPN NO	E2E2-X5C1-M1
			NPN NC	E2E2-X5C2-M1
			PNP NO	E2E2-X5B1-M1
			PNP NC	E2E2-X5B2-M1
	M30	10 mm	NPN NO	E2E2-X10C1-M1
			NPN NC	E2E2-X10C2-M1
			PNP NO	E2E2-X10B1-M1
			PNP NC	E2E2-X10B2-M1
Unshielded 	M12	5 mm	NPN NO	E2E2-X5MC1-M1
			NPN NC	E2E2-X5MC2-M1
			PNP NO	E2E2-X5MB1-M1
			PNP NC	E2E2-X5MB2-M1
	M18	10 mm	NPN NO	E2E2-X10MC1-M1
			NPN NC	E2E2-X10MC2-M1
			PNP NO	E2E2-X10MB1-M1
			PNP NC	E2E2-X10MB2-M1
	M30	18 mm	NPN NO	E2E2-X18MC1-M1
			NPN NC	E2E2-X18MC2-M1
			PNP NO	E2E2-X18MB1-M1
			PNP NC	E2E2-X18MB2-M1

**AC 2-wire/Pre-wired Models**

Size		Sensing distance	Operation mode	Model
Shielded 	M12	2 mm	NO	E2E2-X2Y1
			NC	E2E2-X2Y2
	M18	5 mm	NO	E2E2-X5Y1
			NC	E2E2-X5Y2
	M30	10 mm	NO	E2E2-X10Y1
			NC	E2E2-X10Y2
Unshielded 	M12	5 mm	NO	E2E2-X5MY1
			NC	E2E2-X5MY2
	M18	10 mm	NO	E2E2-X10MY1
			NC	E2E2-X10MY2
	M30	18 mm	NO	E2E2-X18MY1
			NC	E2E2-X18MY2

**AC 2-wire/Connector Models**

Size		Sensing distance	Operation mode	Model
Shielded 	M12	2 mm	NO	E2E2-X2Y1-M4
			NC	E2E2-X2Y2-M4
	M18	5 mm	NO	E2E2-X5Y1-M4
			NC	E2E2-X5Y2-M4
	M30	10 mm	NO	E2E2-X10Y1-M4
			NC	E2E2-X10Y2-M4
Unshielded 	M12	5 mm	NO	E2E2-X5MY1-M4
			NC	E2E2-X5MY2-M4
	M18	10 mm	NO	E2E2-X10MY1-M4
			NC	E2E2-X10MY2-M4
	M30	18 mm	NO	E2E2-X18MY1-M4
			NC	E2E2-X18MY2-M4

# Specifications

## ■ Ratings/Characteristics

### E2E

#### E2E-X□D□ DC 2-wire Models

Item	Size Type	M8		M12		M18		M30	
		Shielded	Unshielded	Shielded	Unshielded	Shielded	Unshielded	Shielded	Unshielded
		E2E-X2D□	E2E-X4MD□	E2E-X3D□	E2E-X8MD□	E2E-X7D□	E2E-X14MD□	E2E-X10D□	E2E-X20MD□
<b>Sensing distance</b>		2 mm ±10%	4 mm ±10%	3 mm ±10%	8 mm ±10%	7 mm ±10%	14 mm ±10%	10 mm ±10%	20 mm ±10%
<b>Set distance (See note 1.)</b>		0 to 1.6 mm	0 to 3.2 mm	0 to 2.4 mm	0 to 6.4 mm	0 to 5.6 mm	0 to 11.2 mm	0 to 8.0 mm	0 to 16.0 mm
<b>Differential travel</b>		15% max. of sensing distance		10% max. of sensing distance					
<b>Sensing object</b>		Ferrous metal (The sensing distance decreases with non-ferrous metal, refer to <i>Engineering Data</i> .)							
<b>Standard sensing object</b>		Iron, 8 x 8 x 1 mm	Iron, 20 x 20 x 1 mm	Iron, 12 x 12 x 1 mm	Iron, 30 x 30 x 1 mm	Iron, 18 x 18 x 1 mm	Iron, 30 x 30 x 1 mm	Iron, 30 x 30 x 1 mm	Iron, 54 x 54 x 1 mm
<b>Response speed (See note 2.)</b>		1.5 kHz	1.0 kHz	1.0 kHz	0.8 kHz	0.5 kHz	0.4 kHz	0.4 kHz	0.1 kHz
<b>Power supply voltage (operating voltage range)</b>		12 to 24 VDC (10 to 30 VDC), ripple (p-p): 10% max.							
<b>Leakage current</b>		0.8 mA max.							
<b>Control output</b>	<b>Load current</b>	3 to 100 mA Diagnostic output: 50 mA for -D1(5)S models							
	<b>Residual voltage (See note 3.)</b>	3 V max. (Load current: 100 mA, Cable length: 2 m. M1J-T models only: 5 V max.)							
<b>Indicator</b>		D1 Models: Operation indicator (red LED), setting indicator (green LED) D2 Models: Operation indicator (red LED)							
<b>Operation mode (with sensing object approaching)</b>		D1 Models: NO D2 Models: NC For details, refer to <i>Timing Charts</i> .							
<b>Diagnostic output delay</b>		0.3 to 1 s							
<b>Protection circuits</b>		Surge suppressor, output load short-circuit protection (for control and diagnostic output)							
<b>Ambient temperature</b>		Operating: -25°C to 70°C, Storage: -40°C to 85°C (with no icing or condensation)							
<b>Ambient humidity</b>		Operating/Storage: 35% to 95% (with no condensation)							
<b>Temperature influence</b>		±15% max. of sensing distance at 23°C in the temperature range of -25°C to 70°C		±10% max. of sensing distance at 23°C in the temperature range of -25°C to 70°C					
<b>Voltage influence</b>		±1% max. of sensing distance in the rated voltage range ±15%							
<b>Insulation resistance</b>		50 MΩ min. (at 500 VDC) between current-carrying parts and case							
<b>Dielectric strength</b>		1,000 VAC at 50/60 Hz for 1 min between current-carrying parts and case							
<b>Vibration resistance</b>		10 to 55 Hz, 1.5-mm double amplitude for 2 hours each in X, Y, and Z directions							
<b>Shock resistance</b>		500 m/s <sup>2</sup> 10 times each in X, Y, and Z directions		1,000 m/s <sup>2</sup> 10 times each in X, Y, and Z directions					
<b>Degree of protection</b>		IEC 60529 IP67 (Pre-wired models, pre-wired connector models: in-house standard for oil resistance (former JEM standard equivalent to IP67g)) (See note 4.)							
<b>Connection method</b>		Pre-wired models (standard length: 2 m), connector models, pre-wired connector models (standard length: 0.3 m)							
<b>Weight (packed state)</b>	<b>Pre-wired models</b>	Approx. 60 g		Approx. 70 g		Approx. 130 g		Approx. 175 g	
	<b>Pre-wired connector models</b>	---		Approx. 40 g		Approx. 70 g		Approx. 110 g	
	<b>Connector models</b>	Approx. 15 g		Approx. 25 g		Approx. 40 g		Approx. 90 g	
<b>Material</b>	<b>Case</b>	Stainless steel (SUS303)		Brass-nickel plated					
	<b>Sensing surface</b>	PBT (polybutylene terephthalate)							
	<b>Clamping nuts</b>	Brass-nickel plated							
	<b>Toothed washer</b>	Iron-zinc plated							
<b>Accessories</b>		Instruction manual							

**Note 1.** Use the E2E within the range in which the setting indicator (green LED) is ON (except D2 models).

- The response speed is an average value. Measurement conditions are as follows: standard sensing object, a distance of twice the standard sensing object, and a set distance of half the sensing distance.
- The residual voltage of each E2E model with the model number suffix “-M1J-T” is 5 V. When connecting an E2E model with the suffix “-M1J-T” to a device, make sure that the device can withstand the residual voltage.
- This OMRON in-house standard confirms resistance to cutting and other oils. It is equivalent to the former JEM standard.



E2E-X□E□/F□ DC 3-wire Models

Item	Size Type	M8		M12		M18		M30	
		Shielded	Unshielded	Shielded	Unshielded	Shielded	Unshielded	Shielded	Unshielded
		E2E-X1R5E□/ F□	E2E-X2ME□/ F□	E2E-X2E□/ F□	E2E-X5ME□/ F□	E2E-X5E□/ F□	E2E-X10ME□/ F□	E2E-X10E□/ F□	E2E-X18ME□/ F□
Sensing distance		1.5 mm ±10%	2 mm ±10%	2 mm ±10%	5 mm ±10%	5 mm ±10%	10 mm ±10%	10 mm ±10%	18 mm ±10%
Set distance		0 to 1.2 mm	0 to 1.6 mm	0 to 1.6 mm	0 to 4.0 mm	0 to 4.0 mm	0 to 8.0 mm	0 to 8.0 mm	0 to 14.0 mm
Differential travel		10% max. of sensing distance							
Sensing object		Ferrous metal (The sensing distance decreases with non-ferrous metal, refer to <i>Engineering Data</i> .)							
Standard sensing object		Iron, 8 x 8 x 1 mm	Iron, 12 x 12 x 1 mm	Iron, 12 x 12 x 1 mm	Iron, 15 x 15 x 1 mm	Iron, 18 x 18 x 1 mm	Iron, 30 x 30 x 1 mm	Iron, 30 x 30 x 1 mm	Iron, 54 x 54 x 1 mm
Response speed (See note 1.)		2.0 kHz	0.8 kHz	1.5 kHz	0.4 kHz	0.6 kHz	0.2 kHz	0.4 kHz	0.1 kHz
Power supply voltage (operating voltage range) (See note 2.)		12 to 24 VDC (10 to 40 VDC), ripple (p-p): 10% max.							
Current consumption		13 mA max.							
Control output	Load current (See note 2.)	200 mA max.							
	Residual voltage	2 V max. (Load current: 200 mA, Cable length: 2 m)							
Indicator		Operation indicator (red LED)							
Operation mode (with sensing object approaching)		E1 F1 Models: NO E2 F2 Models: NC For details, refer to <i>Timing Charts</i> .							
Protection circuits		Power supply reverse polarity protection, surge suppressor, output load short-circuit protection							
Ambient temperature (See note 2)		Operating/Storage: -40°C to 85°C (with no icing or condensation)							
Ambient humidity		Operating/Storage: 35% to 95% (with no icing)							
Temperature influence		±15% max. of sensing distance at 23°C in the temperature range of -40°C to 85°C ±10% max. of sensing distance at 23°C in the temperature range of -25°C to 70°C							
Voltage influence		±1% max. of sensing distance in the rated voltage range ±15%							
Insulation resistance		50 MΩ min. (at 500 VDC) between current-carrying parts and case							
Dielectric strength		1,000 VAC at 50/60 Hz for 1 min between current-carrying parts and case							
Vibration resistance		10 to 55 Hz, 1.5-mm double amplitude for 2 hours each in X, Y, and Z directions							
Shock resistance		500 m/s <sup>2</sup> 10 times each in X, Y, and Z directions 1,000 m/s <sup>2</sup> 10 times each in X, Y, and Z directions							
Degree of protection		IEC 60529 IP67 (Pre-wired models: in-house standard for oil resistance (former JEM standard equivalent to IP67g)) (See note 3.)							
Connection method		Pre-wired models (standard length 2 m), connector models							
Weight (packed state)	Pre-wired models	Approx. 65 g		Approx. 75 g		Approx. 150 g		Approx. 195 g	
	Connector models	Approx. 15 g		Approx. 25 g		Approx. 40 g		Approx. 90 g	
Material	Case	Stainless steel (SUS303)		Brass-nickel plated					
	Sensing surface	PBT (polybutylene terephthalate)							
	Clamping nuts	Brass-nickel plated							
	Toothed washer	Iron-zinc plated							
Accessories		Instruction manual							

- Note 1.** The response speed is an average value. Measurement conditions are as follows: standard sensing object, a distance of twice the standard sensing object, and a set distance of half the sensing distance.
- When using an E2E with an M8 connector at an ambient temperature range between 70°C and 85°C, supply 10 to 30 VDC to the E2E and make sure that the E2E has a control output of 100 mA maximum.
  - This OMRON in-house standard confirms resistance to cutting and other oils. It is equivalent to the former JEM standard.

E2E-C□C□/B□, E2E-X1C□/B□ DC 3-wire Models

Item	Size Type	3 dia.	4 dia.	M5	5.4 dia.
		Shielded			
		E2E-CR6C□/B□	E2E-CR8C□/B□	E2E-X1C□/B□	E2E-C1C□/B□
Sensing distance		0.6 mm ±15%	0.8 mm ±15%	1 mm ±15%	
Set distance		0 to 0.4 mm	0 to 0.5 mm	0 to 0.7 mm	
Differential travel		15% max. of sensing distance			
Sensing object		Ferrous metal (The sensing distance decreases with non-ferrous metal, refer to <i>Engineering Data</i> .)			
Standard sensing object		Iron: 3 x 3 x 1 mm	Iron: 5 x 5 x 1 mm		
Response speed (See note.)		2 kHz	3 kHz		
Power supply voltage (operating voltage range)		12 to 24 VDC (10 to 30 VDC), ripple (p-p): 10% max.			
Current consumption		10 mA max.	17 mA max.		
Control output	Load current	Open-collector output 80 mA max. (at 30 VDC max.)	Open-collector output 100 mA max. (at 30 VDC max.)		
	Residual voltage	1 V max. (Load current: 80 mA, Cable length: 2 m)	2 V max. (Load current: 100 mA, Cable length: 2 m)		
Indicator		Operation indicator (red LED)			
Operation mode (with sensing object approaching)		C1/B1 Models:NO C2/B2 Models:NC For details, refer to <i>Timing Charts</i> .			
Protection circuits		Power supply reverse polarity protection, surge suppressor			
Ambient temperature		Operating/Storage: -25°C to 70°C (with no icing or condensation)			
Ambient humidity		Operating/Storage: 35% to 95%			
Temperature influence		±15% max. of sensing distance at 23°C in the temperature range of -25°C to 70°C			
Voltage influence		±5% max. of sensing distance in the rated voltage range ±10%	±2.5% max. of sensing distance in the rated voltage range ±15%		
Insulation resistance		50 MΩ min. (at 500 VDC) between current-carrying parts and case			
Dielectric strength		500 VAC at 50/60 Hz for 1 min between current-carrying parts and case			
Vibration resistance		10 to 55 Hz, 1.5-mm double amplitude for 2 hours each in X, Y, and Z directions			
Shock resistance		500 m/s <sup>2</sup> 10 times each in X, Y, and Z directions			
Degree of protection		IEC 60529 IP66	IEC 60529 IP67 (Pre-wired models: in-house standard for oil resistance (former JEM standard equivalent to IP67g)) (See note 2.)		
Connection method		Pre-wired models (Standard length 2 m)	Pre-wired models (Standard length 2 m), connector models		
Weight (packed state)	Pre-wired models	Approx. 60 g			
	Connector models	---	Approx. 12 g	Approx. 15 g	---
Material	Case	Stainless steel (SUS303)		Brass-nickel plated	
	Sensing surface	Heat-resistant ABS			
	Clamping nuts	---		Brass-nickel plated	
	Toothed washer	---		Iron-zinc plated	
Accessories		Instruction manual			

**Note 1.** The response speed is an average value. Measurement conditions are as follows: standard sensing object, a distance of twice the standard sensing object, and a set distance of half the sensing distance.

**2.** This OMRON in-house standard confirms resistance to cutting and other oils. It is equivalent to the former JEM standard.

E2E-X□Y□ AC 2-wire Models

Item	Size Type	M8		M12		M18		M30	
		Shielded	Unshielded	Shielded	Unshielded	Shielded	Unshielded	Shielded	Unshielded
		E2E-X1R5Y□	E2E-X2MY□	E2E-X2Y□	E2E-X5MY□	E2E-X5Y□	E2E-X10MY□	E2E-X10Y□	E2E-X18MY□
<b>Sensing distance</b>		1.5 mm ±10%	2 mm ±10%	2 mm ±10%	5 mm ±10%	5 mm ±10%	10 mm ±10%	10 mm ±10%	18 mm ±10%
<b>Set distance</b>		0 to 1.2 mm	0 to 1.6 mm	0 to 1.6 mm	0 to 4.0 mm	0 to 4.0 mm	0 to 8.0 mm	0 to 8.0 mm	0 to 14.0 mm
<b>Differential travel</b>		10% max. of sensing distance							
<b>Sensing object</b>		Ferrous metal (The sensing distance decreases with non-ferrous metal, refer to <i>Engineering Data</i> .)							
<b>Standard sensing object</b>		Iron, 8 x 8 x 1 mm	Iron, 12 x 12 x 1 mm	Iron, 12 x 12 x 1 mm	Iron, 15 x 15 x 1 mm	Iron, 18 x 18 x 1 mm	Iron, 30 x 30 x 1 mm	Iron, 30 x 30 x 1 mm	Iron, 54 x 54 x 1 mm
<b>Response speed</b>		25 Hz							
<b>Power supply voltage (operating voltage range) (See note 1.)</b>		24 to 240 VAC, 50/60 Hz (20 to 264 VAC)							
<b>Leakage current</b>		1.7 mA max.							
<b>Control output</b>	<b>Load current (See note 2.)</b>	5 to 100 mA		5 to 200 mA		5 to 300 mA			
	<b>Residual voltage</b>	Refer to <i>Engineering Data</i> .							
<b>Indicator</b>		Operation indicator (red LED)							
<b>Operation mode (with sensing object approaching)</b>		Y1 Models: NO Y2 Models: NC For details, refer to <i>Timing Charts</i> .							
<b>Protection circuit</b>		Surge suppressor							
<b>Ambient temperature (See notes 1 and 2.)</b>		Operating/Storage: -25°C to 70°C (with no icing or condensation)		Operating/Storage: -40°C to 85°C (with no icing or condensation)					
<b>Ambient humidity</b>		Operating/Storage: 35% to 95% (with no condensation)							
<b>Temperature influence</b>		±10% max. of sensing distance at 23°C in the temperature range of -25°C to 70°C		±15% max. of sensing distance at 23°C in the temperature range of -40°C to 85°C ±10% max. of sensing distance at 23°C in the temperature range of -25°C to 70°C					
<b>Voltage influence</b>		±1% max. of sensing distance in the rated voltage range ±15%							
<b>Insulation resistance</b>		50 MΩ min. (at 500 VDC) between current-carrying parts and case							
<b>Dielectric strength</b>		4,000 VAC at 50/60 Hz for 1 min between current-carrying parts and case (2,000 VAC for M8 Models)							
<b>Vibration resistance</b>		10 to 55 Hz, 1.5-mm double amplitude for 2 hours each in X, Y, and Z directions							
<b>Shock resistance</b>		500 m/s <sup>2</sup> 10 times each in X, Y, and Z directions		1,000 m/s <sup>2</sup> 10 times each in X, Y, and Z directions					
<b>Degree of protection</b>		IEC 60529 IP67 (Pre-wired models: in-house standard for oil resistance (former JEM standard equivalent to IP67g)) (See note 3.)							
<b>Connection method</b>		Pre-wired models (standard length 2 m), connector models							
<b>Weight (packed state)</b>	<b>Pre-wired models</b>	Approx. 60 g		Approx. 70 g		Approx. 130 g		Approx. 175 g	
	<b>Connector models</b>	Approx. 15 g		Approx. 25 g		Approx. 40 g		Approx. 90 g	
<b>Material</b>	<b>Case</b>	Stainless steel (SUS303)		Brass-nickel plated					
	<b>Sensing surface</b>	PBT (polybutylene terephthalate)							
	<b>Clamping nuts</b>	Brass-nickel plated							
	<b>Toothed washer</b>	Iron-zinc plated							
<b>Accessories</b>		Instruction manual							

**Note 1.** When supplying 24 VAC to any of the above models, make sure that the operating ambient temperature range is over -25°C.

**2.** When using an M18-or M30-sized E2E within an ambient temperature of 70°C to 85°C, make sure that the E2E has a control output of 5 to 200 mA max.

**3.** This OMRON in-house standard confirms resistance to cutting and other oils. It is equivalent to the former JEM standard.

AC/DC 2-wire Models

Item	Size Type	M12	M18	M30
		Shielded		
		E2E-X3T1	E2E-X7T1	E2E-X10T1
Sensing distance		3 mm ±10%	7 mm ±10%	10 mm ±10%
Set distance		0 to 2.4 mm	0 to 5.6 mm	0 to 8.0 mm
Differential travel		10% max. of sensing distance		
Sensing object		Ferrous metal (The sensing distance decreases with non-ferrous metal, refer to <i>Engineering Data</i> .)		
Standard sensing object		Iron, 12 x 12 x 1 mm	Iron, 18 x 18 x 1 mm	Iron, 30 x 30 x 1 mm
Response speed (See note 1.)	DC	1.0 kHz	0.5 kHz	0.4 kHz
	AC	25 Hz		
Power supply voltage (operating voltage range) (See note 2.)		24 to 240 VDC (20 to 264 VDC)/48 to 240 VAC (40 to 264 VAC)		
Leakage current		1 mA DC max., 2 mA AC max.		
Control output	Load current	5 to 100 mA		
	Residual voltage	6.0 VDC max. (Load current: 100 mA, Cable length: 2 m) 10 VAC max. (Load current: 5 mA, Cable length: 2 m)		
Indicator		Operation indicator (red LED), setting indicator (green LED)		
Operation mode (with sensing object approaching)		NO For details, refer to <i>Timing Charts</i> .		
Protection circuits		Output load short-circuit protection (at 20 to 40 VDC), Surge suppressor		
Ambient temperature		Operating: -25°C to 70°C, Storage: -40°C to 85°C (with no icing or condensation)		
Ambient humidity		Operating/Storage: 35% to 95% (with no condensation)		
Temperature influence		±10% max. of sensing distance at 23°C in the temperature range of -25°C to 70°C		
Voltage influence		±1% max. of sensing distance in the rated voltage range ±15%		
Insulation resistance		50 MΩ min. (at 500 VDC) between current-carrying parts and case		
Dielectric strength		4,000 VAC at 50/60 Hz for 1 min between current-carrying parts and case		
Vibration resistance		10 to 55 Hz, 1.5-mm double amplitude for 2 hours each in X, Y, and Z directions		
Shock resistance		1,000 m/s <sup>2</sup> 10 times each in X, Y, and Z directions		
Degree of protection		IEC 60529 IP67 In-house standard for oil resistance (former JEM standard equivalent to IP67g) (See note 3.)		
Connection method		Pre-wired Models (standard length 2 m)		
Weight (packed state)		Approx. 80 g	Approx. 140 g	Approx. 190 g
Material	Case	Brass-nickel plated		
	Sensing surface	PBT (polybutylene terephthalate)		
	Clamping nuts	Brass-nickel plated		
	Toothed washer	Iron-zinc plated		
Accessories		Instruction manual		

**Note 1.** The response speed is an average value. Measurement conditions are as follows: standard sensing object, a distance of twice the standard sensing object, and a set distance of half the sensing distance.

**2.** Power supply voltage waveform: Use a sine wave for the power supply. Using a rectangular AC power supply may result in faulty reset.

**3.** This OMRON in-house standard confirms resistance to cutting and other oils. It is equivalent to the former JEM standard.

**E2E2**

**E2E2-X□D□ DC 2-wire Models**

Item	Size Type	M12		M18		M30	
		Shielded	Unshielded	Shielded	Unshielded	Shielded	Unshielded
		E2E2-X3D□	E2E2-X8MD□	E2E2-X7D□	E2E2-X14MD□	E2E2-X10D□	E2E2-X20MD□
<b>Sensing distance</b>		3 mm ±10%	8 mm ±10%	7 mm ±10%	14 mm ±10%	10 mm ±10%	20 mm ±10%
<b>Set distance (See note 1.)</b>		0 to 2.4 mm	0 to 6.4 mm	0 to 5.6 mm	0 to 11.2 mm	0 to 8.0 mm	0 to 16.0 mm
<b>Differential travel</b>		10% max. of sensing distance					
<b>Sensing object</b>		Ferrous metal (The sensing distance decreases with non-ferrous metal, refer to <i>Engineering Data</i> .)					
<b>Standard sensing object</b>		Iron, 12 x 12 x 1 mm	Iron, 30 x 30 x 1 mm	Iron, 18 x 18 x 1 mm	Iron, 30 x 30 x 1 mm	Iron, 30 x 30 x 1 mm	Iron, 54 x 54 x 1 mm
<b>Response speed (See note 2.)</b>		1.0 kHz	0.8 kHz	0.5 kHz	0.4 kHz	0.4 kHz	0.1 kHz
<b>Power supply voltage (operating voltage range)</b>		12 to 24 VDC (10 to 30 VDC), ripple (p-p): 10% max.					
<b>Leakage current</b>		0.8 mA max.					
<b>Control output</b>	<b>Load current</b>	3 to 100 mA					
	<b>Residual voltage</b>	3.0 V max. (Load current: 100 mA, Cable length: 2 m)					
<b>Indicator</b>		D1 Models: Operation indicator (red LED), setting indicator (green LED) D2 Models: Operation indicator (red LED)					
<b>Operation mode (with sensing object approaching)</b>		D1 Models: NO D2 Models: NC For details, refer to <i>Timing charts</i> .					
<b>Protection circuits</b>		Surge suppressor, output load short-circuit protection					
<b>Ambient temperature</b>		Operating/Storage: -25°C to 70°C (with no icing or condensation)					
<b>Ambient humidity</b>		Operating/Storage: 35% to 95% (with no condensation)					
<b>Temperature influence</b>		±10% max. of sensing distance at 23°C in the temperature range of -25°C to 70°C					
<b>Voltage influence</b>		±1% max. of sensing distance in the rated voltage range ±15%					
<b>Insulation resistance</b>		50 MΩ min. (at 500 VDC) between current-carrying parts and case					
<b>Dielectric strength</b>		1,000 VAC at 50/60 Hz for 1 min between current-carrying parts and case					
<b>Vibration resistance</b>		10 to 55 Hz, 1.5-mm double amplitude for 2 hours each in X, Y, and Z directions					
<b>Shock resistance</b>		1,000 m/s <sup>2</sup> 10 times each in X, Y, and Z directions					
<b>Degree of protection</b>		IEC 60529 IP67 In-house standard for oil resistance (former JEM standard equivalent to IP67g) (See note 3.)					
<b>Connection method</b>		Pre-wired models (standard length 2 m)					
<b>Weight (packed state)</b>		Approx. 65 g		Approx. 150 g		Approx. 210 g	
<b>Material</b>	<b>Case</b>	Brass					
	<b>Sensing surface</b>	PBT (polybutylene terephthalate)					
	<b>Clamping nuts</b>	Brass-nickel plated					
	<b>Toothed washer</b>	Iron-zinc plated					
<b>Accessories</b>		Instruction manual					

**Note 1.** Use the E2E2 within the range in which the setting indicator (green LED) is lit (except D2 models).

**2.** The response speed is an average value. Measurement conditions are as follows: standard sensing object, a distance of twice the standard sensing object, and a set distance of half the sensing distance.

**3.** This OMRON in-house standard confirms resistance to cutting and other oils. It is equivalent to the former JEM standard.

E2E2-X□C□/B□ DC 3-wire Models

Item	Size Type	M12		M18		M30	
		Shielded	Unshielded	Shielded	Unshielded	Shielded	Unshielded
		E2E2-X2C□/ B□	E2E2-X5MC□/ B□	E2E2-X5C□/ B□	E2E2-X10MC□/ B□	E2E2-X10C□/ B□	E2E2-X18MC□/ B□
Sensing distance		2 mm ±10%	5 mm ±10%	5 mm ±10%	10 mm ±10%	10 mm ±10%	18 mm ±10%
Set distance		0 to 1.6 mm	0 to 4.0 mm	0 to 4.0 mm	0 to 8.0 mm	0 to 8.0 mm	0 to 14.0 mm
Differential travel		10% max. of sensing distance					
Sensing object		Ferrous metal (The sensing distance decreases with non-ferrous metal, refer to <i>Engineering Data</i> .)					
Standard sensing object		Iron, 12 x 12 x 1 mm	Iron, 15 x 15 x 1 mm	Iron, 18 x 18 x 1 mm	Iron, 30 x 30 x 1 mm	Iron, 30 x 30 x 1 mm	Iron, 54 x 54 x 1 mm
Response speed (See note 1.)		1.5 kHz	0.4 kHz	0.6 kHz	0.2 kHz	0.4 kHz	0.1 kHz
Power supply voltage (operating voltage range) (See note.)		12 to 24 VDC (10 to 55 VDC), ripple (p-p): 10% max.					
Current consumption		13 mA max.					
Control output	Load current	200 mA max., open collector (55 VDC max.)					
	Residual voltage	2 V max. (Load current: 200 mA, Cable length: 2 m)					
Indicator		Operation indicator (red LED)					
Operation mode (with sensing object approaching)		B1/C1 Models: NO B2/C2 Models: NC For details, refer to <i>Timing Charts</i> .					
Protection circuits		Surge suppressor, output load short-circuit protection, power supply reverse polarity protection					
Ambient temperature		Operating/Storage: -40°C to 85°C (with no icing or condensation)					
Ambient humidity		Operating/Storage: 35% to 95% (with no condensation)					
Temperature influence		±15% max. of sensing distance at 23°C in the temperature range of -40°C to 85°C ±10% max. of sensing distance at 23°C in the temperature range of -25°C to 70°C					
Voltage influence		±1% max. of sensing distance in the rated voltage range ±15%					
Insulation resistance		50 MΩ min. (at 500 VDC) between current-carrying parts and case					
Dielectric strength		1,000 VAC at 50/60 Hz for 1 min between current-carrying parts and case					
Vibration resistance		10 to 55 Hz, 1.5-mm double amplitude for 2 hours each in X, Y, and Z directions					
Shock resistance		1,000 m/s <sup>2</sup> 10 times each in X, Y, and Z directions					
Degree of protection		IEC 60529 IP67 In-house standard for oil resistance (former JEM standard equivalent to IP67g) (See note 3.)					
Connection method		Pre-wired models (standard length: 2 m)					
Weight (packed state)		Approx. 75 g		Approx. 160 g		Approx. 220 g	
Material	Case	Brass					
	Sensing surface	PBT (polybutylene terephthalate)					
	Clamping nuts	Brass-nickel plated					
	Toothed washer	Iron-zinc plated					
Accessories		Instruction manual					

**Note 1.** The response speed is an average value. Measurement conditions are as follows: standard sensing object, a distance of twice the standard sensing object, and a set distance of half the sensing distance.

**2.** An unsmoothed full-wave rectification power supply of 24 VDC ±20% (average value) can be used.

**3.** This OMRON in-house standard confirms resistance to cutting and other oils. It is equivalent to the former JEM standard.

## E2E2-X□Y□ AC 2-wire Models

Item	Size Type	M12		M18		M30	
		Shielded	Unshielded	Shielded	Unshielded	Shielded	Unshielded
		E2E2-X2Y□	E2E2-X5MY□	E2E2-X5Y□	E2E2-X10MY□	E2E2-X10Y□	E2E2-X18MY□
<b>Sensing distance</b>		2 mm ±10%	5 mm ±10%	5 mm ±10%	10 mm ±10%	10 mm ±10%	18 mm ±10%
<b>Set distance</b>		0 to 1.6 mm	0 to 4.0 mm	0 to 4.0 mm	0 to 8.0 mm	0 to 8.0 mm	0 to 14.0 mm
<b>Differential travel</b>		10% max. of sensing distance					
<b>Sensing object</b>		Ferrous metal (The sensing distance decreases with non-ferrous metal, refer to <i>Engineering Data</i> .)					
<b>Standard sensing object</b>		Iron, 12 x 12 x 1 mm	Iron, 15 x 15 x 1 mm	Iron, 18 x 18 x 1 mm	Iron, 30 x 30 x 1 mm	Iron, 30 x 30 x 1 mm	Iron, 54 x 54 x 1 mm
<b>Response speed</b>		25 Hz					
<b>Power supply voltage (operating voltage range) (See note 1.)</b>		24 to 240 VAC, 50/60 Hz (20 to 264 VAC)					
<b>Leakage current</b>		1.7 mA max.					
<b>Control output</b>	<b>Load current (See note 2.)</b>	5 to 200 mA		5 to 300 mA			
	<b>Residual voltage</b>	Refer to <i>Engineering Data</i> .					
<b>Indicator</b>		Operation indicator (red LED)					
<b>Operation mode (with sensing object approaching)</b>		Y1 Models: NO Y2 Models: NC For details, refer to <i>Timing Charts</i> .					
<b>Ambient temperature</b>		Operating/Storage: -40°C to 85°C (with no icing or condensation) (See notes 1 and 2.)					
<b>Ambient humidity</b>		Operating/Storage: 35% to 95% (with no condensation)					
<b>Temperature influence</b>		±15% max. of sensing distance at 23°C in the temperature range of -40°C to 85°C ±10% max. of sensing distance at 23°C in the temperature range of -25°C to 70°C					
<b>Voltage influence</b>		±1% max. of sensing distance in the rated voltage range ±15%					
<b>Insulation resistance</b>		50 MΩ min. (at 500 VDC) between current-carrying parts and case					
<b>Dielectric strength</b>		4,000 VAC at 50/60 Hz for 1 min between current-carrying parts and case					
<b>Vibration resistance</b>		10 to 55 Hz, 1.5-mm double amplitude for 2 hours each in X, Y, and Z directions					
<b>Shock resistance</b>		1,000 m/s <sup>2</sup> , 10 times each in X, Y, and Z directions					
<b>Degree of protection</b>		IEC 60529 IP67 In-house standard for oil resistance (former JEM standard equivalent to IP67g) (See note 3.)					
<b>Connection method</b>		Pre-wired models (standard length: 2 m)					
<b>Weight (packed state)</b>		Approx. 65 g		Approx. 150 g		Approx. 210 g	
<b>Material</b>	<b>Case</b>	Brass					
	<b>Sensing surface</b>	PBT (polybutylene terephthalate)					
	<b>Clamping nuts</b>	Brass-nickel plated					
	<b>Toothed washer</b>	Iron-zinc plated					
<b>Accessories</b>		Instruction manual					

**Note 1.** When supplying 24 VAC to any of the above models, make sure that the operating ambient temperature range is -25°C to 85°C.

**2.** When using an M18-or M30-sized E2E2 within an ambient temperature of 70°C to 85°C, make sure that the E2E2 has a control output of 5 to 200 mA maximum.

**3.** This OMRON in-house standard confirms resistance to cutting and other oils. It is equivalent to the former JEM standard.

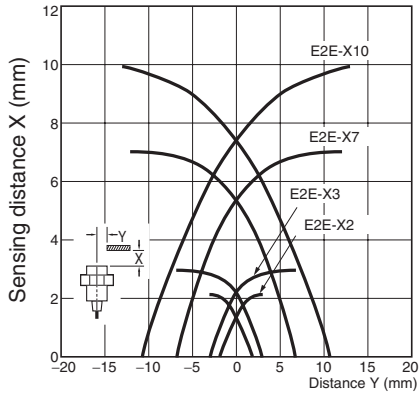
# Engineering Data

## E2E

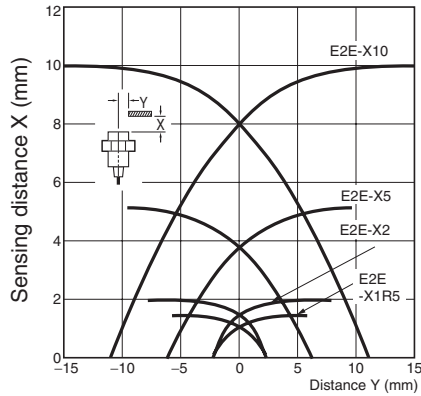
### Operating Range (Typical)

#### Shielded Models

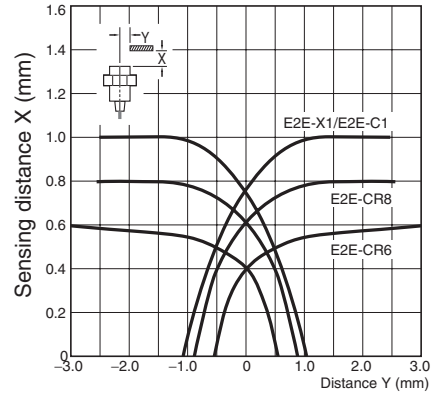
E2E-X□D□  
E2E-X□T1



E2E-X□E□/F□  
E2E-X□Y□

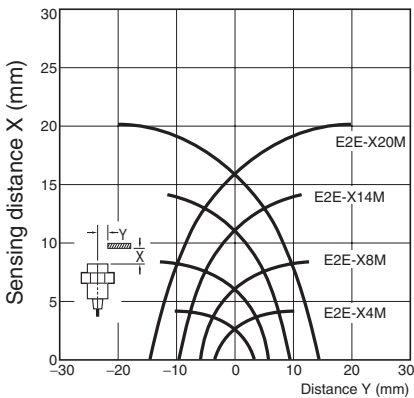


E2E-C□C□/B□  
E2E-X□C□/B□

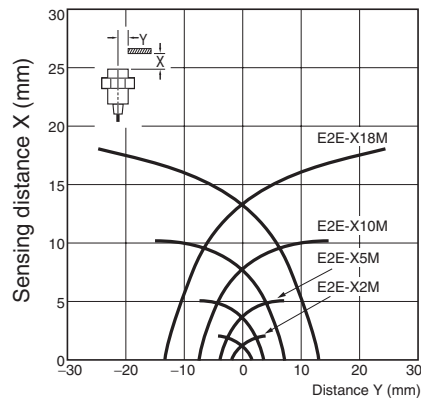


#### Unshielded Models

E2E-X□MD□



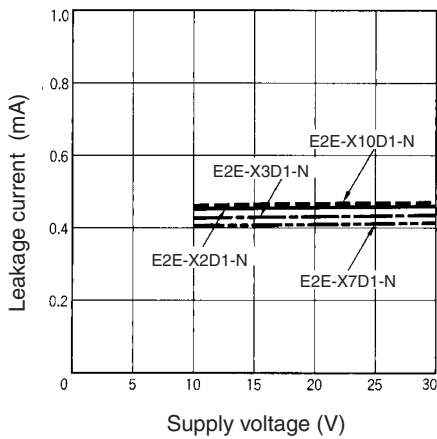
E2E-X□ME□/F□  
E2E-X□MY□



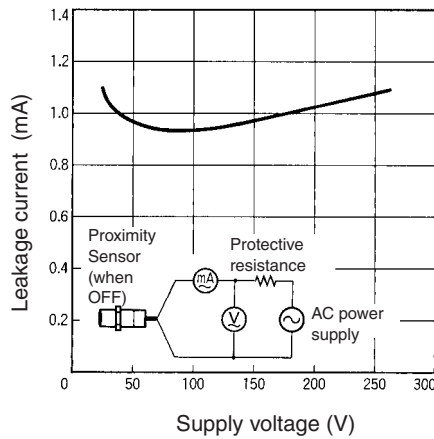


### Leakage Current (Typical)

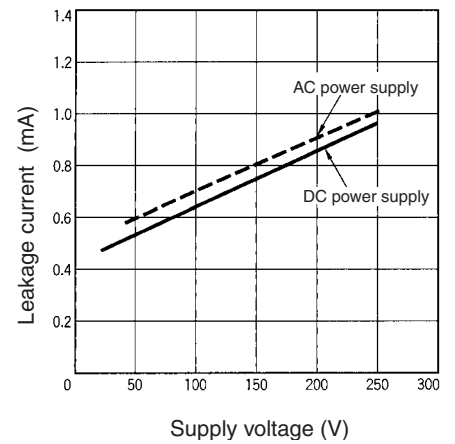
E2E-X□D□



E2E-X□Y□

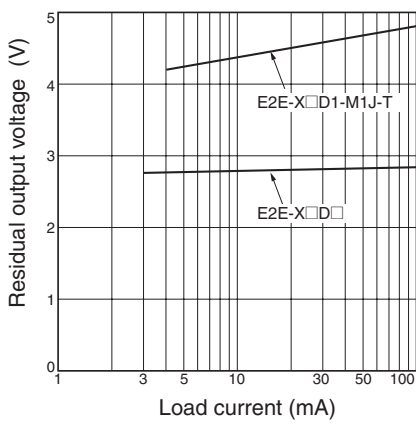


E2E-X□T1  
DC/AC

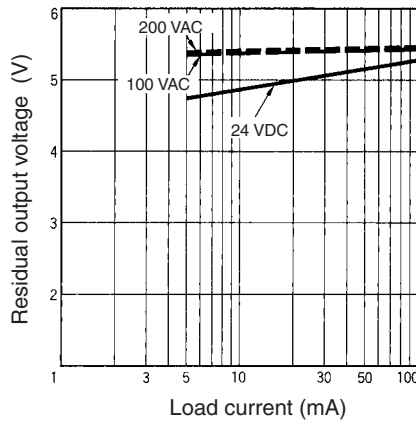


### Residual Output Voltage (Typical)

E2E-X□D□

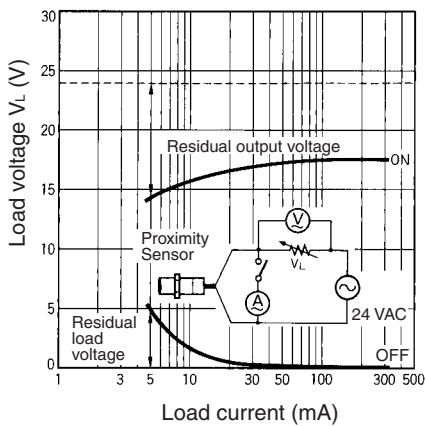


E2E-X□T1

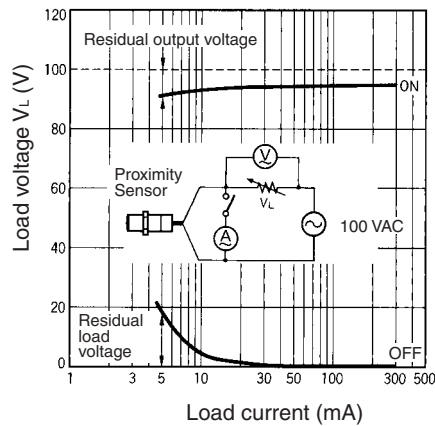


E2E-X□Y□

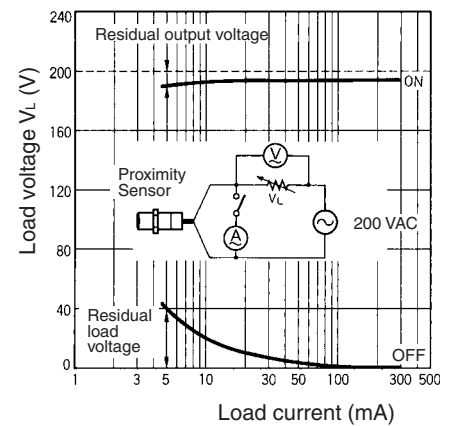
24 VAC



100 VAC

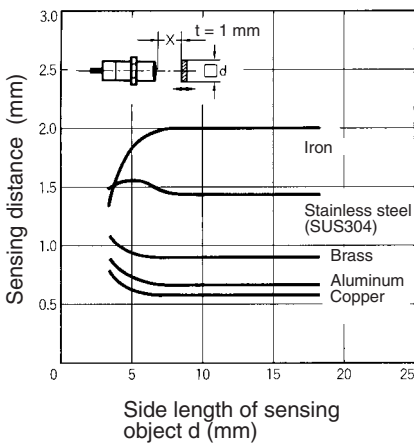


200 VAC

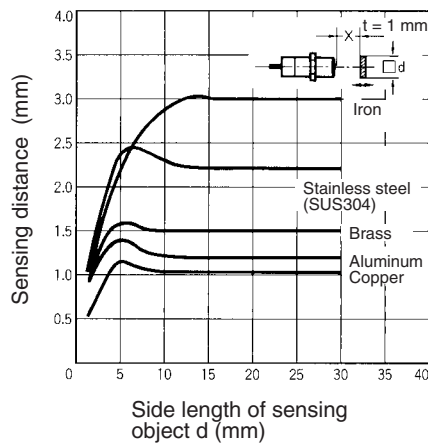


Sensing Distance vs. Sensing Object (Typical)

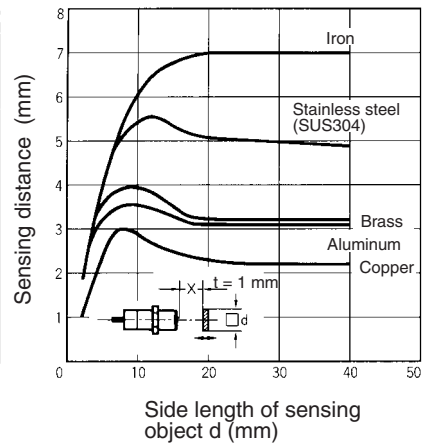
E2E-X2D□



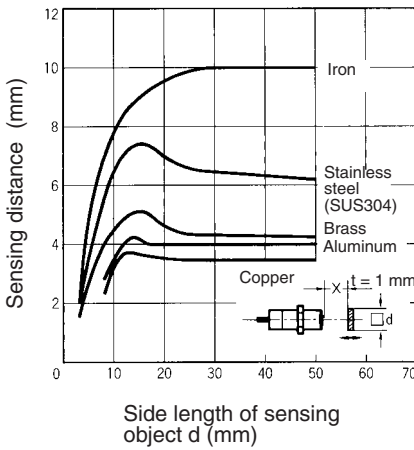
E2E-X3D□  
E2E-X3T1



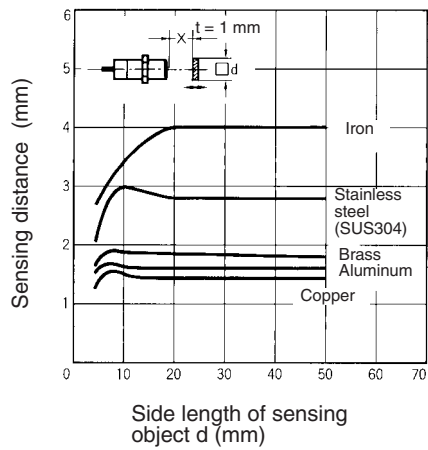
E2E-X7D□  
E2E-X7T1



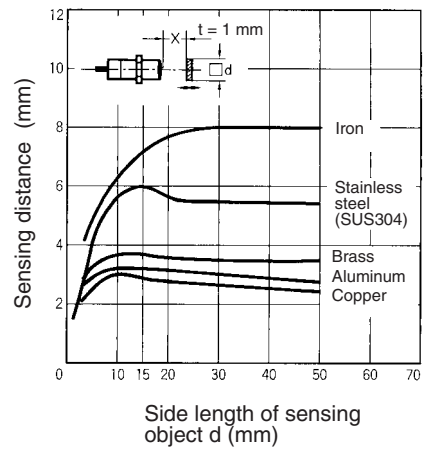
E2E-X10D□  
E2E-X10T1



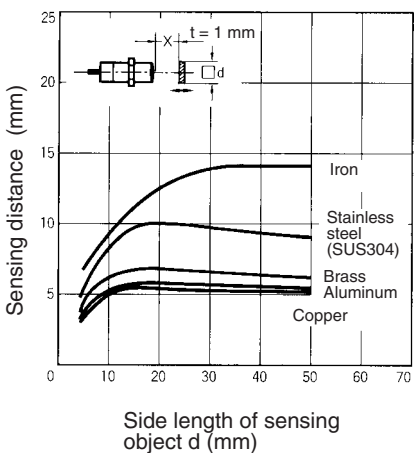
E2E-X4MD□



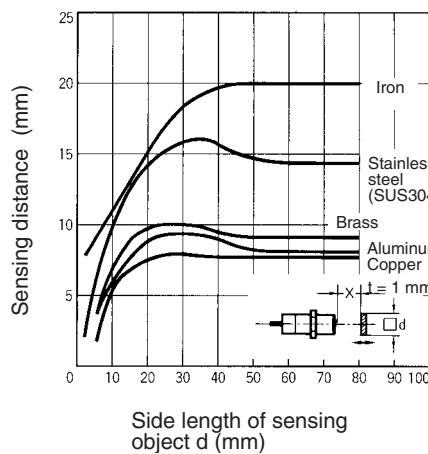
E2E-X8MD□



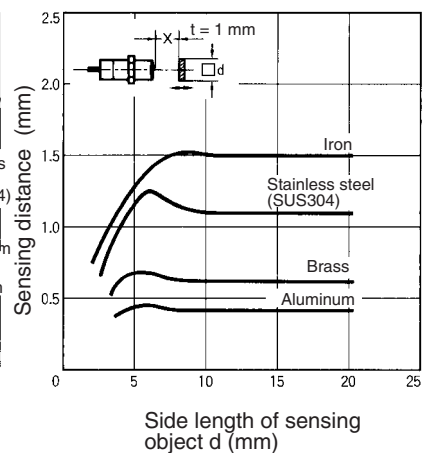
E2E-X14MD□



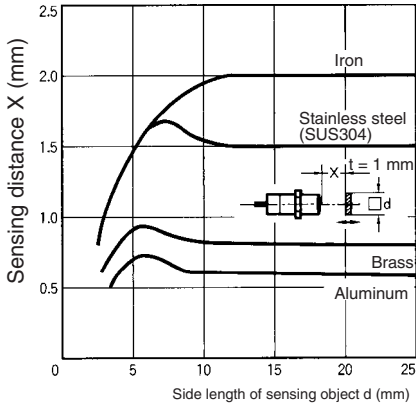
E2E-X20MD□



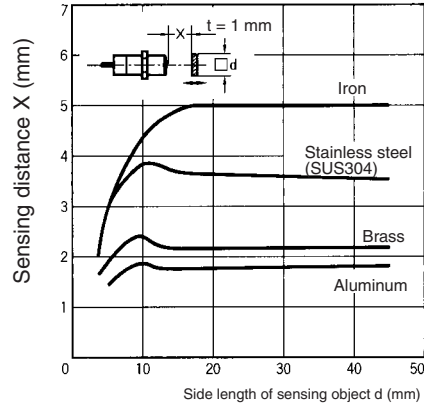
E2E-X1R5E□/F□  
E2E-X1R5Y□



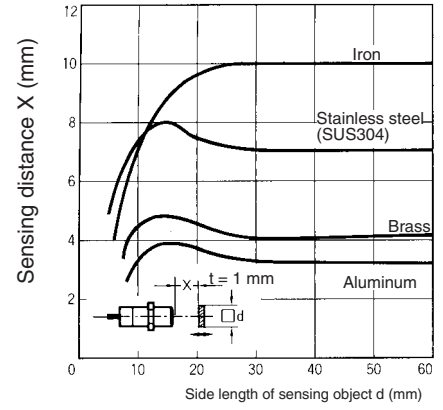
**E2E-X2E□/F□**  
**E2E-X2Y□**



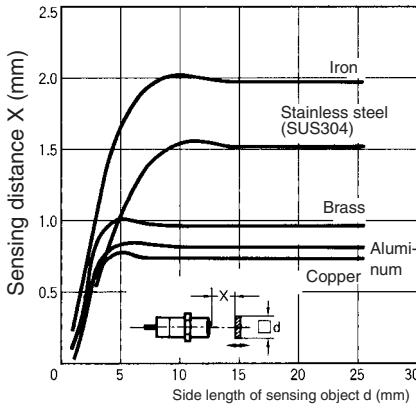
**E2E-X5E□/F□**  
**E2E-X5Y□**



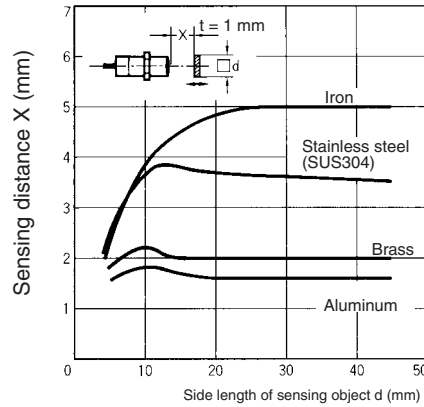
**E2E-X10E□/F□**  
**E2E-X10Y□**



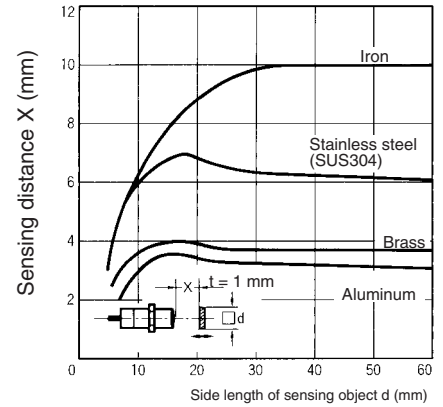
**E2E-X2ME□/F□**  
**E2E-X2MY□**



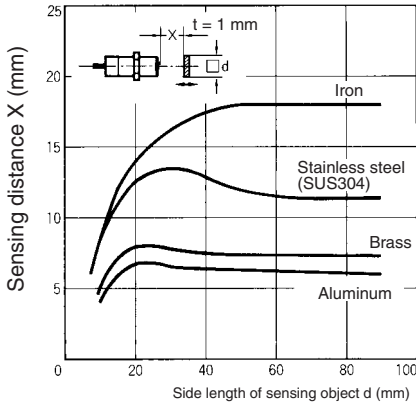
**E2E-X5ME□/F□**  
**E2E-X5MY□**



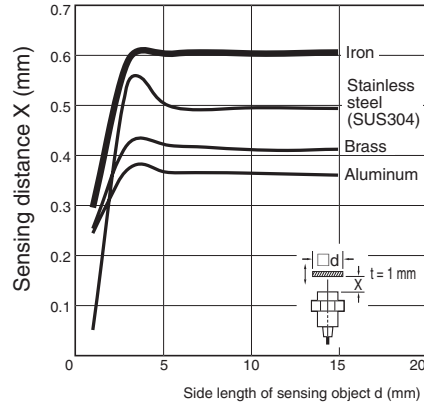
**E2E-X10ME□/F□**  
**E2E-X10MY**



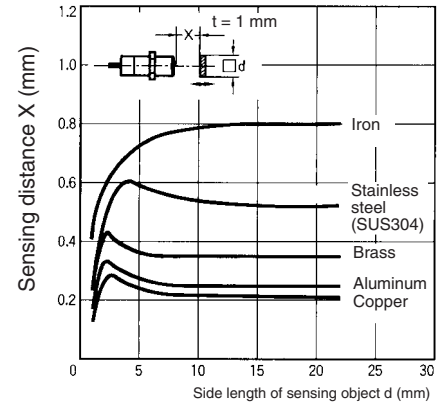
**E2E-X18ME□/F□**  
**E2E-X18MY□**



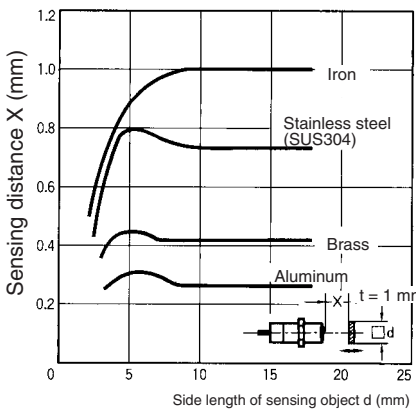
**E2E-CR6□□**



**E2E-CR8□□**



**E2E-X1□□**  
**E2E-C1□□**

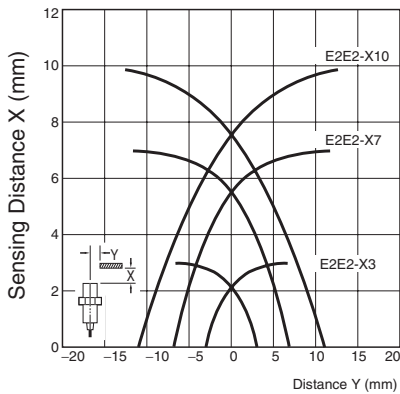


## E2E2

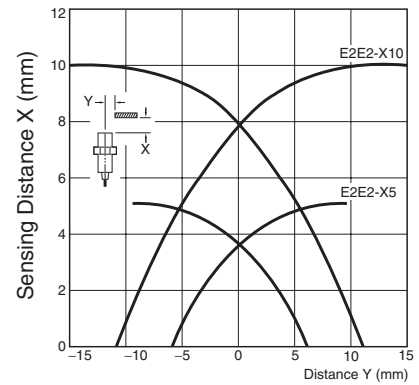
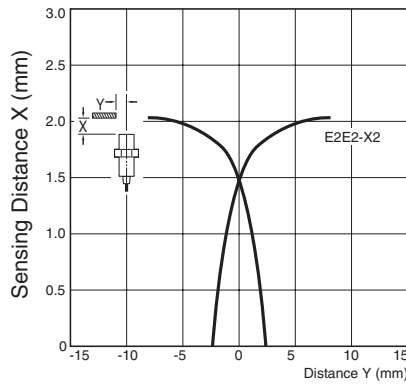
### Operating Range (Typical)

#### Shielded Models

E2E2-X□D□

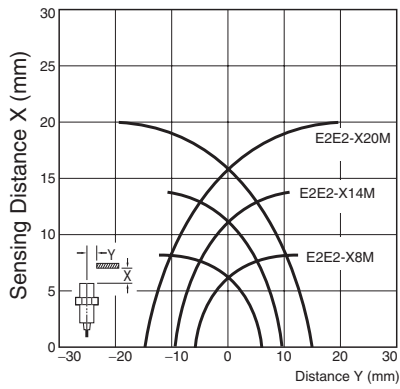


E2E2-X□C□/B□  
E2E2-X□Y□

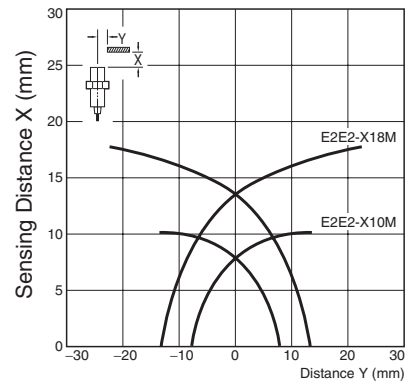
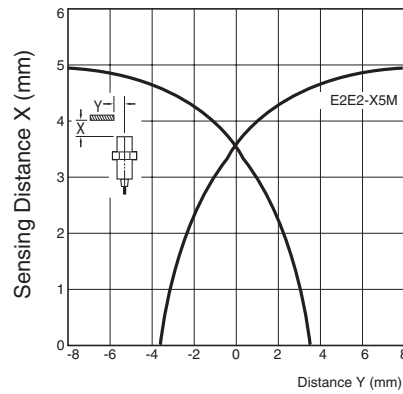


#### Unshielded Models

E2E2-X□MD□

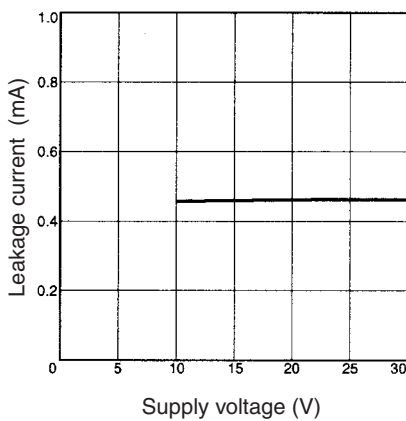


E2E2-X□MC□/B□  
E2E2-X□MY□

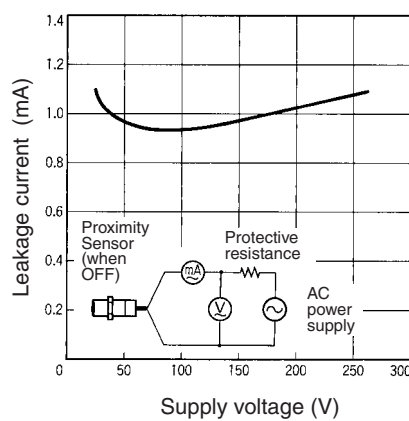


### Leakage Current (Typical)

E2E2-X□D□

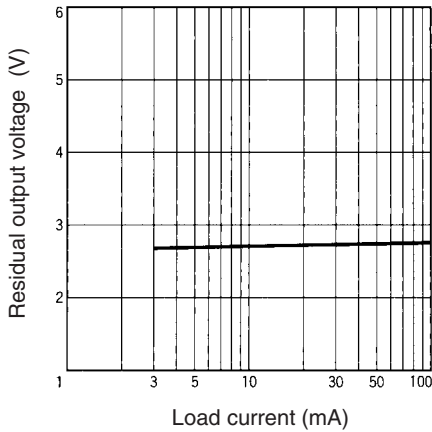


E2E2-X□Y□



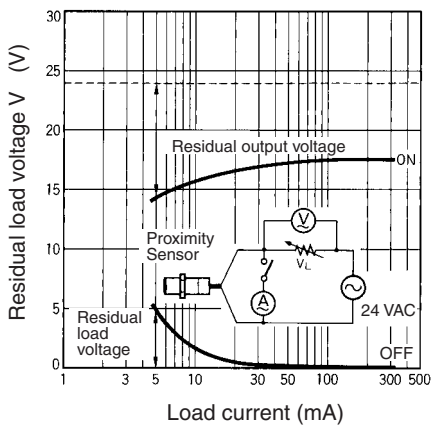
### Residual Output Voltage (Typical)

E2E2-X□D□

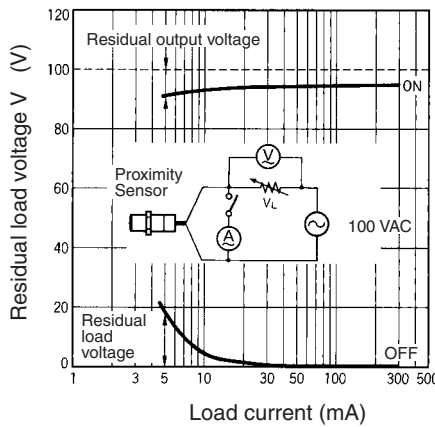


E2E2-X□Y□

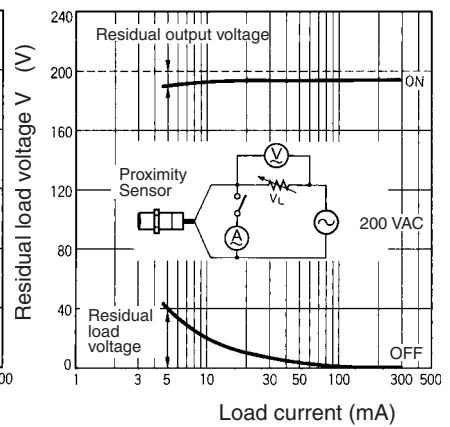
24 VAC



100 VAC

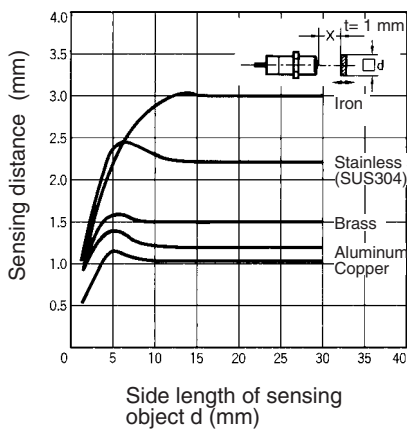


200 VAC

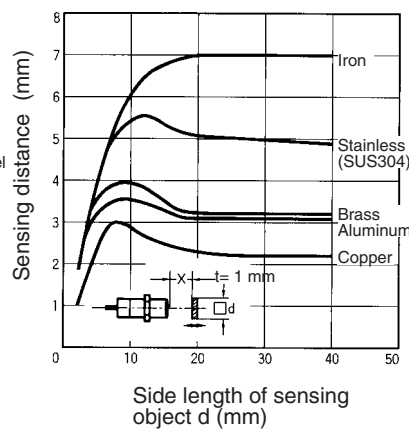


### Sensing Distance vs. Sensing Object (Typical)

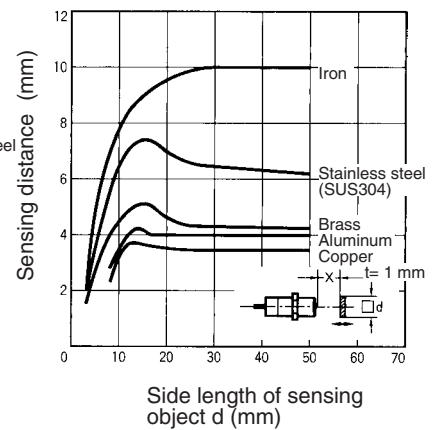
E2E2-X3D□



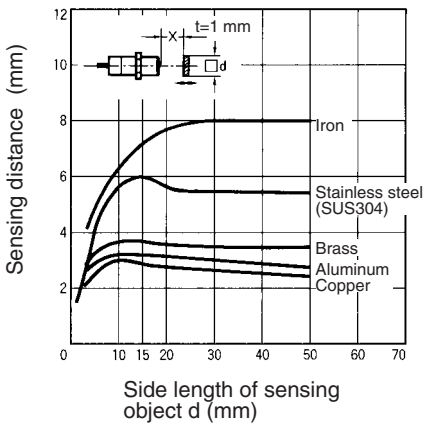
E2E2-X7D□



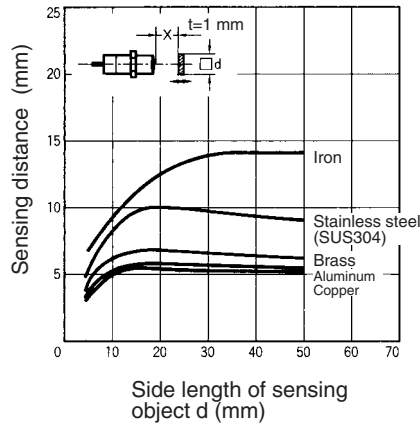
E2E2-X10D□



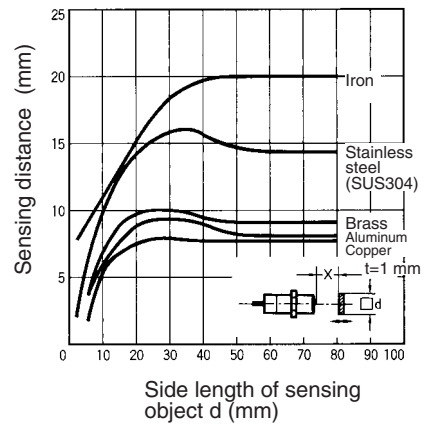
**E2E2-X8MD**



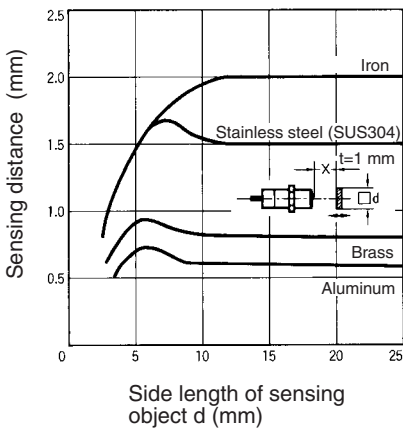
**E2E2-X14MD**



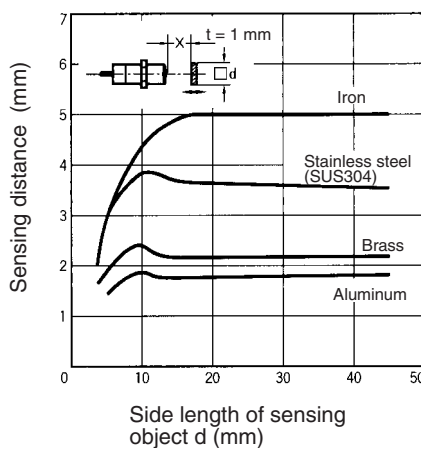
**E2E2-X20MD**



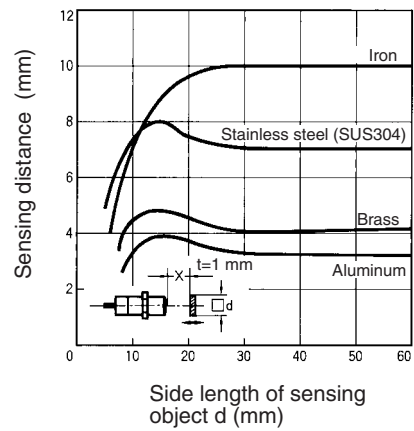
**E2E2-X2C/B**  
**E2E2-X2Y**



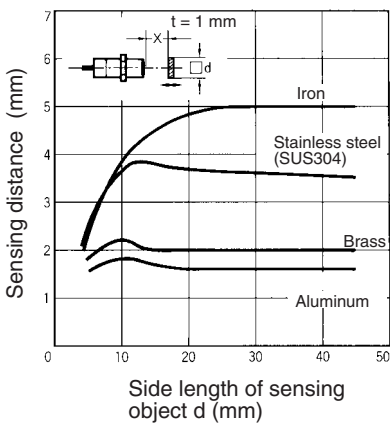
**E2E2-X5C/B**  
**E2E2-X5Y**



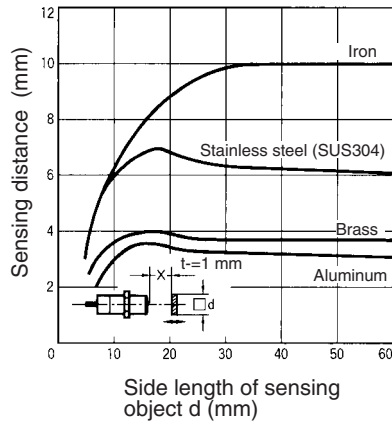
**E2E2-X10C/B**  
**E2E2-X10Y**



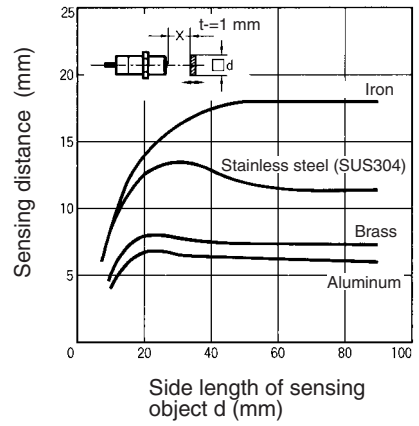
**E2E2-X5MC/B**  
**E2E2-X5MY**



**E2E2-X10MC/B**  
**E2E2-X10MY**



**E2E2-X18MC/B**  
**E2E2-X18MY**



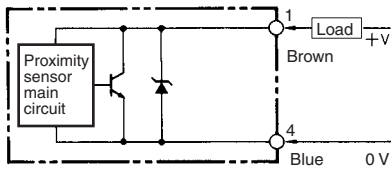
# Output Circuits and Timing Charts

## Output Circuits

### E2E

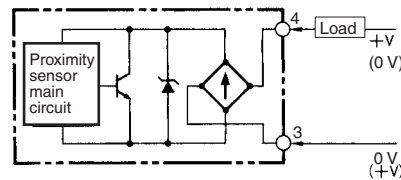
#### E2E-X□D□ DC 2-wire Models

**E2E-X□D1 Without Diagnostic Output**



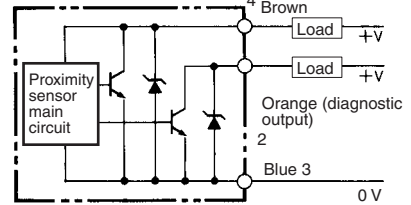
- Note:** 1. The load can be connected to either the +V or 0 V side.  
 2. The pin numbers in the above diagram are for the -M□G(J). For the -M1, pin 4 is +V and pin 3 is 0 V.

**E2E-X□D1-M1J-T No Polarity**



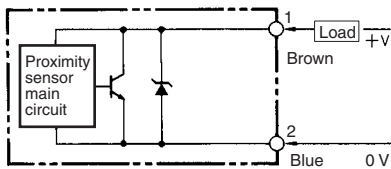
- Note:** 1. The load can be connected to either the +V or 0 V side.  
 2. The E2E-X□D1-M1J-T has no polarity. Therefore, terminals 3 and 4 have no polarity.

**E2E-X□D1S With Diagnostic Output**



- Note:** Connect both the loads to the +V side of the control output and diagnostic output.

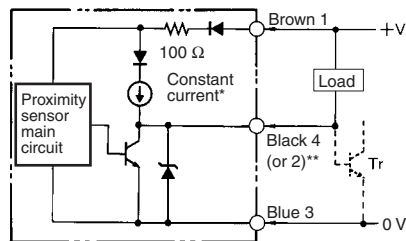
**E2E-X□D2 Without Diagnostic Output**



- Note:** 1. The load can be connected to either the +V or 0 V side.  
 2. The pin numbers in the above diagram are for the -M□G. For -M1 models, pin 2 is +V and pin 3 is 0 V.

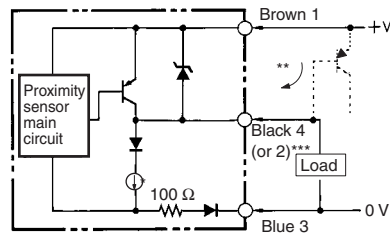
#### DC 3-wire Models

**E2E-X□E□ NPN Output**



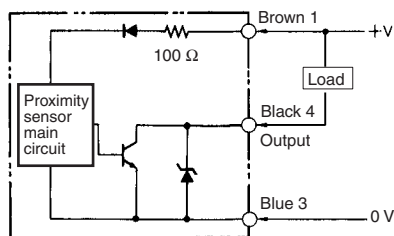
- \* Constant current output is 1.5 to 3 mA.  
 \*\* Pin 4 is an NO contact, and pin 2 is an NC contact.

**E2E-X□F□ PNP Output**



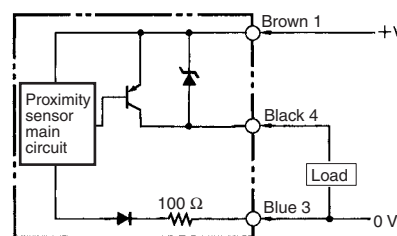
- \* Constant current output is 1.5 to 3 mA.  
 \*\* When connecting to a Tr circuit.  
 \*\*\* Pin 4 is an NO contact, and pin 2 is an NC contact.

**E2E-C/X□C□ NPN Open-collector Output**



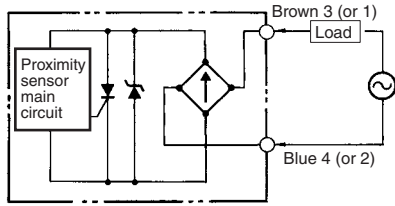
- \* E2E-CR6□ has no 100-Ω resistance.

**E2E-C/X□B□ PNP Open-collector Output**



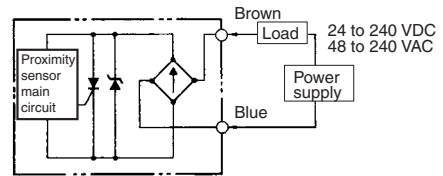
- \* E2E-CR6□ has no 100-Ω resistance.

**E2E-X□Y□ AC 2-wire Models**



**Note:** For connector models, the connection between pins 3 and 4 uses an NO contact, and the connection between pins 1 and 2 uses an NC contact.

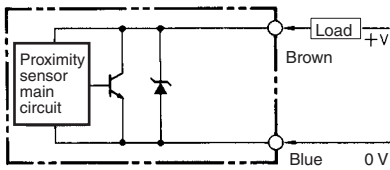
**E2E-X□T1 AC/DC 2-wire Models**



**Note:** The load can be connected to either the +V or 0 V side. There is no need to be concerned about the polarity (Brown/Blue) of the Proximity Sensor.

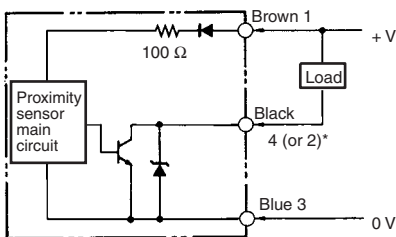
**E2E2**

**E2E2-X□D□ DC 2-wire Models**



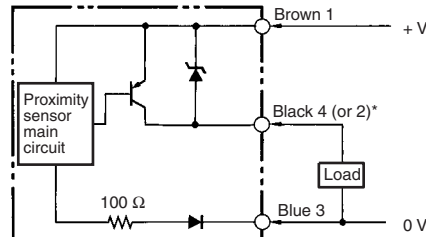
**Note:** The load can be connected to either the +V or 0 V side.

**E2E2-X□C□ DC 3-wire Models**



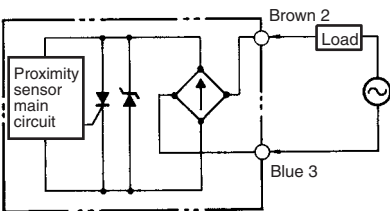
\* Pin 4 is an NO contact, and pin 2 is an NC contact.

**E2E2-X□B□ DC 3-wire Models**



\* Pin 4 is an NO contact, and pin 2 is an NC contact.

**E2E2-X□Y□ DC 2-wire Models**





# Timing Charts

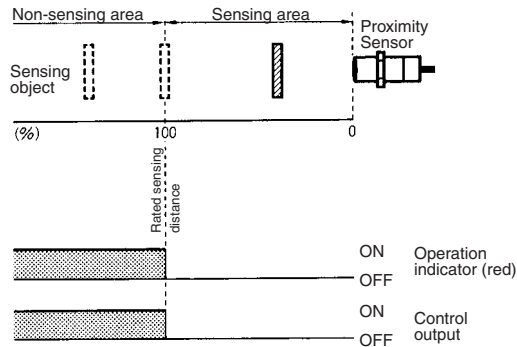
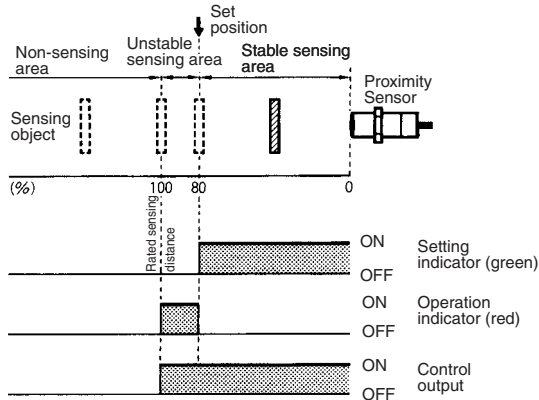
## E2E

### E2E-X□D□ DC 2-wire Models

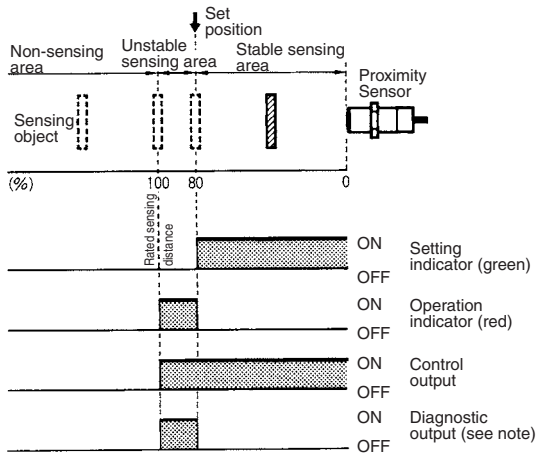
### E2E-X□T1 AC/DC 2-wire Models

E2E-X□D1  
E2E-X□T1  
NO Models

E2E-X□D2  
NC Models



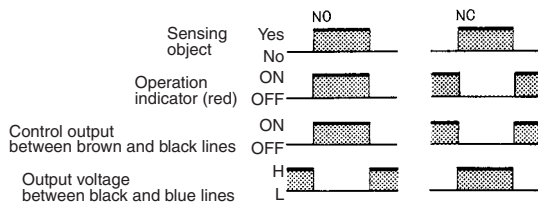
### E2E-X□D1S



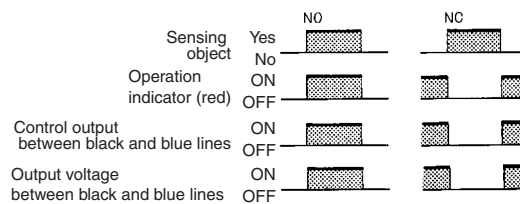
**Note:** The diagnostic output of the E2E-X□D1S is ON when there is a coil burnout or the sensing object is located in the unstable sensing range for 0.3 s or more.

## DC 3-wire Models

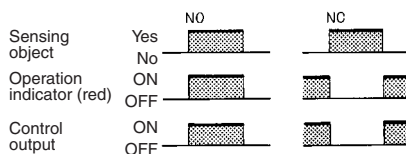
E2E-X□E□  
NPN Output



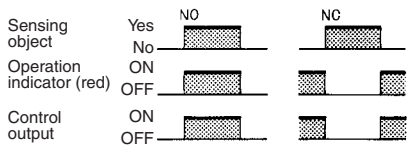
E2E-X□F□  
PNP Output



E2E-C/X□C□/B□  
NPN/PNP Open-collector Output



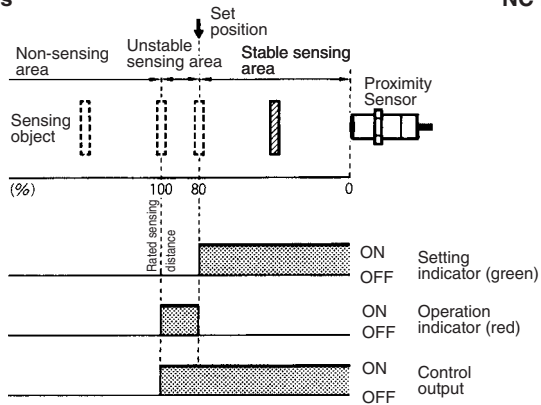
**E2E-X□Y□ AC 2-wire Models**



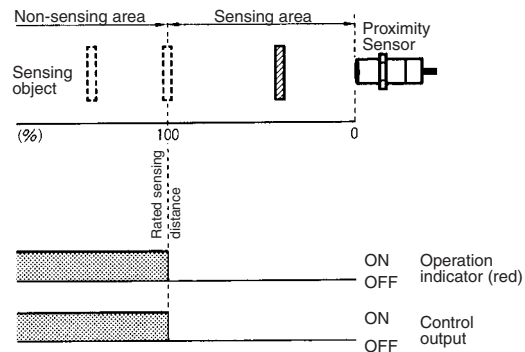
**E2E2**

**E2E2-X□D□ DC 2-wire Models**

**NO Models**

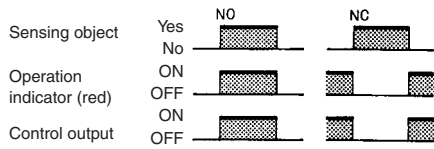


**NC Models**

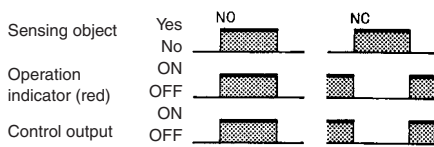


**E2E2-X□C□/B□ DC 3-wire Models**

**NPN/PNP Open-collector Output**



**E2E2-X□Y□ AC 2-wire Models**



# Installation

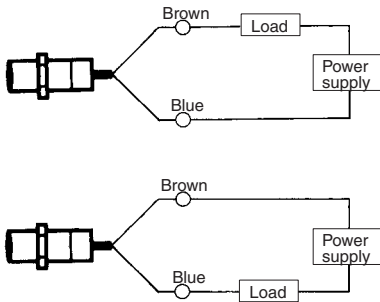
## ■ Connection

### E2E

**E2E-X□D□**  
DC 2-wire Models  
(Without Diagnostic Output)

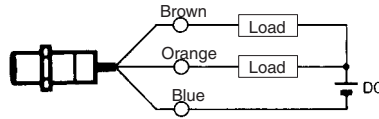
**E2E-X□Y□**  
AC 2-wire Models

**E2E-X□T1**  
AC/DC 2-wire Models



**Note:** The load can be connected as shown above.

**E2E-X□D1S**  
DC 3-wire Models  
(With Diagnostic Output)

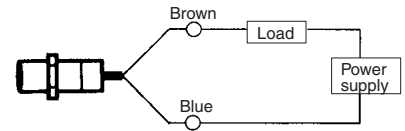


**Note:** The control output and diagnostic output share the negative common terminal. Therefore, the loads must be connected to the positive sides of the control output and diagnostic output.

**E2E-X□D1-M1J-T**  
DC 2-wire Models  
(No Polarity)

**E2E-X□Y□**  
AC 2-wire Models

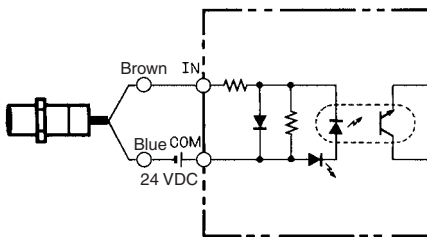
**E2E-X□T1**  
AC/DC 2-wire Models



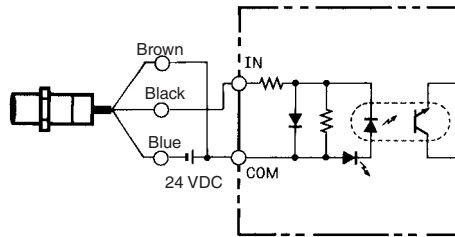
**Note:** There is no need to be concerned about the polarity (Brown/Blue) of the Proximity Sensor.

### Connected to PC

**E2E-X□D□**  
DC 2-wire Models

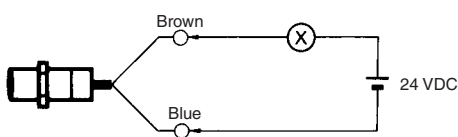


**E2E-X□E□**  
DC 3-wire Models

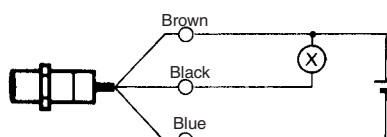


### Connected to Relay Load

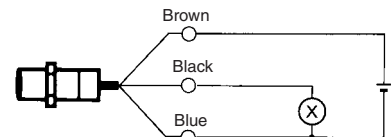
**E2E-X□D□**  
DC 2-wire Models



**E2E-X□E□**  
DC 3-wire Models



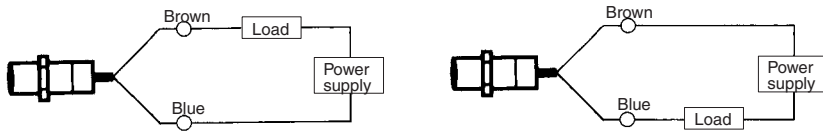
**E2E-X□F□**  
DC 3-wire Models



## E2E2

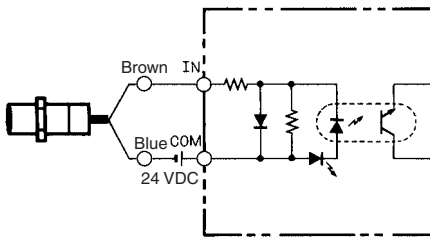
E2E2-X□D□  
DC 2-wire Models

E2E2-X□Y□  
AC 2-wire Models

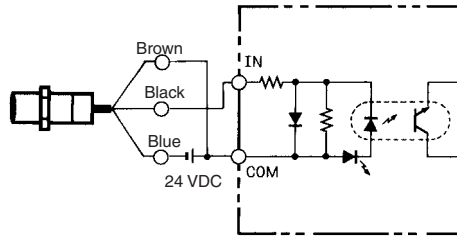


**Note:** The load can be connected as shown in the above diagrams.

Connected to PC  
E2E2-X□D□  
DC 2-wire Models



E2E2-X□C□  
DC 3-wire Models



# Pin Arrangement

## E2E-X□D□-M□ DC 2-wire Models

Connector	Self-diagnostic output	Operation mode	Applicable models	Pin arrangement
M12	No	NO	E2E-X□D1-M1G□ (See note.)	<p><b>Note:</b> Terminals 2 and 3 are not used.</p>
			E2E-X□D1-M1J-T	<p><b>Note:</b> 1. Terminals 1 and 2 are not used. 2. Terminals 3 and 4 has no polarity.</p>
			E2E-X□D1-M1	<p><b>Note:</b> Terminals 1 and 2 are not used.</p>
	Yes	NC	E2E-X□D2-M1G (See note.)	<p><b>Note:</b> Terminals 3 and 4 are not used.</p>
			E2E-X□D2-M1	<p><b>Note:</b> Terminal 1 is not used.</p>
			E2E-X□D1S-M1	<p>(Self-diagnostic output)</p> <p><b>Note:</b> Terminals 1 is not used.</p>
M8	No	NO	E2E-X□D1-M3G	<p><b>Note:</b> Terminals 2 and 3 are not used.</p>
			NC	E2E-X□D2-M3G

**Note:** The above pin arrangements conform to IEC standards.

**E2E-X□E/F□-M□ DC 3-wire Models**

Connector	Operation mode	Applicable models	Pin arrangement
M12	NO	E2E-X□E1-M1	<p><b>Note:</b> Terminal 2 is not used.</p>
		E2E-X□F1-M1	<p><b>Note:</b> Terminal 2 is not used.</p>
	NC	E2E-X□E2-M1	<p><b>Note:</b> Terminal 4 is not used.</p>
		E2E-X□F2-M1	<p><b>Note:</b> Terminal 4 is not used.</p>
M8	NO	E2E-X□E1-M3	<p><b>Note:</b> Terminal 2 is not used.</p>
		E2E-X□F1-M3	<p><b>Note:</b> Terminal 2 is not used.</p>
	NC	E2E-X□E2-M3	<p><b>Note:</b> Terminal 4 is not used.</p>
		E2E-X□F2-M3	<p><b>Note:</b> Terminal 4 is not used.</p>

**E2E-CR8□/CR8B□/X1C□/X1B□-M5 DC 3-wire Models**

Connector	Operation mode	Applicable models	Pin arrangement
M8-3pin	NO/NC	E2E-CR8□-M5 E2E-X1C□-M5	
	NO/NC	E2E-CR8B□-M5 E2E-X1B□-M5	

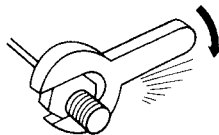
**E2E-X□Y□-M1 AC 2-wire Models**

Operation mode	Applicable models	Pin arrangement
NO	E2E-X□Y1-M1	<p><b>Note:</b> Terminals 1 and 2 are not used.</p>
NC	E2E-X□Y2-M1	<p><b>Note:</b> Terminals 3 and 4 are not used.</p>

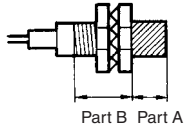
**Precautions**

**Mounting**

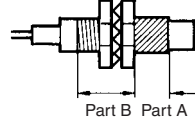
Do not tighten the nut with excessive force. A washer must be used with the nut.



Shielded Model



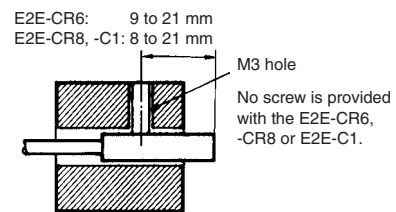
Unshielded Model



**Note:** The table below shows the tightening torques for part A and part B nuts. In the previous examples, the nut is on the sensor head side (part B) and hence the tightening torque for part B applies. If this nut is in part A, the tightening torque for part A applies instead.

Model	Part A		Part B Torque
	Length	Torque	
M5	1 N·m		
M8	Shielded	9 mm	9 N·m
	Unshielded	3 mm	12 N·m
M12	30 N·m		
M18	70 N·m		
M30	180 N·m		

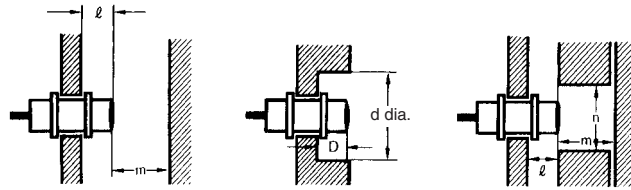
Refer to the following to mount the E2E-CR6, -CR8 and E2E-C1 non-screw models.



Tighten the screw to a torque of 0.2 N·m maximum to secure the E2E-CR6, -CR8 and a torque of 0.4 N·m maximum to secure the E2E-C1.

### Influence of Surrounding Metal

When mounting the E2E within a metal panel, ensure that the clearances given in the following table are maintained. Failure to maintain these distances may cause deterioration in the performance of the sensor.



Model	Item	M8	M12	M18	M30	
E2E-X□D□ DC 2-wire E2E-X□T1 AC/DC 2-wire E2E2-X□D□ DC 2-wire	Shielded	l	0 mm			
		d	8 mm	12 mm	18 mm	30 mm
		D	0 mm			
		m	4.5 mm	8 mm	20 mm	40 mm
		n	12 mm	18 mm	27 mm	45 mm
	Unshielded	l	12 mm	15 mm	22 mm	30 mm
		d	24 mm	40 mm	70 mm	90 mm
		D	12 mm	15 mm	22 mm	30 mm
		m	8 mm	20 mm	40 mm	70 mm
		n	24 mm	40 mm	70 mm	90 mm
E2E-X□E□ E2E-X□F□ DC 3-wire E2E-X□Y□ AC 2-wire E2E2-X□B□ E2E2-X□C□ DC 3-wire E2E2-X□Y□ AC 2-wire	Shielded	l	0 mm			
		d	8 mm	12 mm	18 mm	30 mm
		D	0 mm			
		m	4.5 mm	8 mm	20 mm	40 mm
		n	12 mm	18 mm	27 mm	45 mm
	Unshielded	l	6 mm	15 mm	22 mm	30 mm
		d	24 mm	40 mm	55 mm	90 mm
		D	6 mm	15 mm	22 mm	30 mm
		m	8 mm	20 mm	40 mm	70 mm
		n	24 mm	36 mm	54 mm	90 mm

Model	Item	3 dia.	4 dia.	M5	5.4 dia.	
E2E-X□C□ E2E-X□B□ E2E-C□C□ E2E-C□B□ DC 3-wire	Shielded	l	0 mm			
		d	3 mm	4 mm	5 mm	5.4 mm
		D	0 mm			
		m	2 mm	2.4 mm	3 mm	3 mm
		n	6 mm	6 mm	8 mm	8 mm



## Relationship between Sizes and Models

### E2E

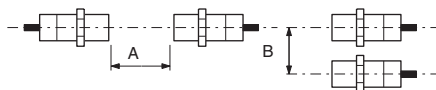
Model		Model No.
3 dia.	Shielded	E2E-CR6C□ E2E-CR6B□
4 dia.		E2E-CR8C□ E2E-CR8B□
M5		E2E-X1C□ E2E-X1B□
5.4 dia.		E2E-C1C□ E2E-C1B□
M8	Shielded	E2E-X2D□ E2E-X1R5E□/F□ E2E-X1R5Y□
	Unshielded	E2E-X4MD□ E2E-X2ME□/F□ E2E-X2MY□
M12	Shielded	E2E-X3D□ E2E-X2E□/F□ E2E-X2Y□ E2E-X3T1
	Unshielded	E2E-X8MD□ E2E-X5ME□/F□ E2E-X5MY□
M18	Shielded	E2E-X7D□ E2E-X5E□/F□ E2E-X5Y□ E2E-X7T1
	Unshielded	E2E-X14MD□ E2E-X10ME□/F□ E2E-X10MY□
M30	Shielded	E2E-X10D□ E2E-X10E□/F□ E2E-X10Y□ E2E-X10T1
	Unshielded	E2E-X20MD□ E2E-X18ME□/F□ E2E-X18MY□

### E2E2

Model		Model No.
M12	Shielded	E2E2-X3D□ E2E2-X2C□/B□ E2E2-X2Y□
	Unshielded	E2E2-X8MD□ E2E2-X5MC□/B□ E2E2-X5MY□
M18	Shielded	E2E2-X7D□ E2E2-X5C□/B□ E2E2-X5Y□
	Unshielded	E2E2-X14MD□ E2E2-X10MC□/B□ E2E2-X10MY□
M30	Shielded	E2E2-X10D□ E2E2-X10C□/B□ E2E2-X10Y□
	Unshielded	E2E2-X20MD□ E2E2-X18MC□/B□ E2E2-X18MY□

## Mutual Interference

When installing two or more Sensors face to face or side by side, ensure that the minimum distances given in the following table are maintained.



Model		Item	M8	M12	M18	M30
E2E-X□D□ DC 2-wire	Shielded	A	20 mm	30 (20) mm	50 (30) mm	100 (50) mm
		B	15 mm	20 (12) mm	35 (18) mm	70 (35) mm
E2E-X□T1 AC/DC 2-wire	Unshielded	A	80 mm	120 (60) mm	200 (100) mm	300 (100) mm
		B	60 mm	100 (50) mm	110 (60) mm	200 (100) mm
E2E2-X□D□ DC 2-wire	Shielded	A	20 mm	30 (20) mm	50 (30) mm	100 (50) mm
		B	15 mm	20 (12) mm	35 (18) mm	70 (35) mm
E2E-X□E□ E2E-X□F□ DC 3-wire	Unshielded	A	80 mm	120 (60) mm	200 (100) mm	300 (100) mm
		B	60 mm	100 (50) mm	110 (60) mm	200 (100) mm
E2E-X□Y□ AC 2-wire	Shielded	A	20 mm	30 (20) mm	50 (30) mm	100 (50) mm
		B	15 mm	20 (12) mm	35 (18) mm	70 (35) mm
E2E2-X□B□ E2E2-X□C□ DC 3-wire	Unshielded	A	80 mm	120 (60) mm	200 (100) mm	300 (100) mm
		B	60 mm	100 (50) mm	110 (60) mm	200 (100) mm
E2E2-X□Y□ AC 2-wire	Shielded	A	20 mm	30 (20) mm	50 (30) mm	100 (50) mm
		B	15 mm	20 (12) mm	35 (18) mm	70 (35) mm

Model		Item	3 dia.	4 dia.	M5	5.4 dia.
E2E-X□B□ E2E-X□C□ E2E-C□B□ E2E-C□C□ DC 3-wire	Shielded	A	20 mm			
		B	15 mm			

**Note:** Values in parentheses apply to Sensors operating at different frequencies.

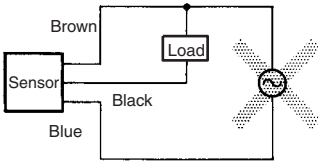
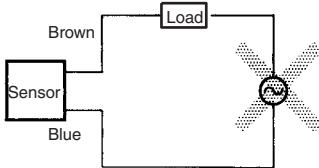
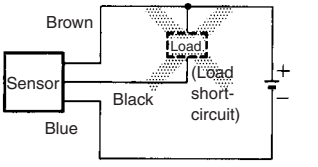
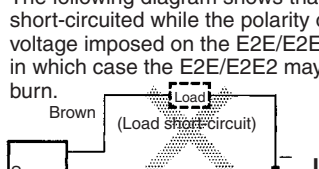
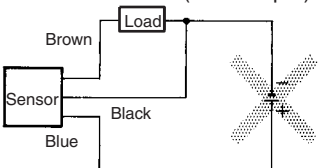
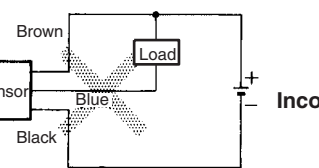
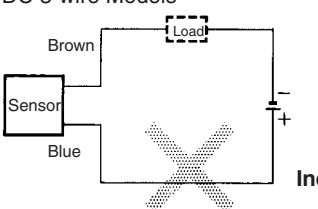
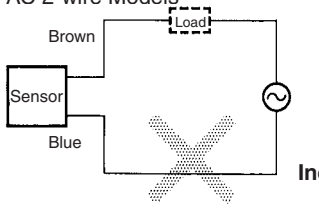
**⚠ WARNING**

This product is not designed or rated for ensuring safety of persons.  
Do not use it for such purposes.



**■ Precautions for Safe Use**

The colors in parentheses are previous wire colors.

Item	Examples	
<p><b>Power supply</b></p> <p>Do not impose an excessive voltage on the E2E/E2E2, otherwise it may explode or burn. Do not impose 100 VAC on any E2E/E2E2 DC Model, otherwise it may explode or burn.</p>	<p>DC 3-wire Models</p> 	<p>DC 2-wire Models</p> 
<p><b>Load short-circuit</b></p> <p>Do not short-circuit the load, or the E2E/E2E2 may explode or burn.</p> <p>The E2E/E2E2's short-circuit protection function is valid if the polarity of the supply voltage imposed is correct and within the rated voltage range.</p>	<p>DC 3-wire Models (NPN output)</p> 	<p>DC 2-wire Models</p> <p>The following diagram shows that the load is short-circuited while the polarity of the supply voltage imposed on the E2E/E2E2 is wrong, in which case the E2E/E2E2 may explode or burn.</p> 
<p><b>Wiring</b></p> <p>Be sure to wire the E2E/E2E2 and load correctly, otherwise it may explode or burn.</p>	<p>DC 3-wire Models (NPN output)</p> 	
<p><b>Connection with no load</b></p> <p>Make sure to connect a proper load to the E2E/E2E2 in operation, otherwise it may explode or burn.</p>	<p>DC 3-wire Models</p> 	<p>AC 2-wire Models</p> 

**■ Precautions for Correct Use**

**Installation**

**Power Reset Time**

The Proximity Sensor is ready to operate within 100 ms after power is supplied. If power supplies are connected to the Proximity Sensor and load respectively, be sure to supply power to the Proximity Sensor before supplying power to the load.

**Power OFF**

The Proximity Sensor may output a pulse signal when it is turned OFF. Therefore, it is recommended to turn OFF the load before turning OFF the Proximity Sensor.

**Power Supply Transformer**

When using a DC power supply, make sure that the DC power supply has an insulated transformer. Do not use a DC power supply with an auto-transformer.

**Sensing Object**

Metal Coating:

The sensing distances of the Proximity Sensor vary with the metal coating on sensing objects.

## Wiring

### High-tension Lines

#### Wiring through Metal Conduit

If there is a power or high-tension line near the cable of the Proximity Sensor, wire the cable through an independent metal conduit to prevent against Proximity Sensor damage or malfunctioning.

#### Cable Tractive Force

Do not pull on cables with tractive forces exceeding the following.

Diameter	Tractive force
4 dia. max.	30 N max.
4 dia. min.	50 N max.

## Mounting

The Proximity Sensor must not be subjected to excessive shock with a hammer when it is installed, otherwise the Proximity Sensor may be damaged or lose its water-resistivity.

## Environment

### Water Resistivity

Do not use the Proximity Sensor underwater, outdoors, or in the rain.

### Operating Environment

Be sure to use the Proximity Sensor within its operating ambient temperature range and do not use the Proximity Sensor outdoors so that its reliability and life expectancy can be maintained. Although the Proximity Sensor is water resistive, a cover to protect the Proximity Sensor from water or water soluble machining oil is recommended so that its reliability and life expectancy can be maintained.

Do not use the Proximity Sensor in an environment with chemical gas (e.g., strong alkaline or acid gasses including nitric, chromic, and concentrated sulfuric acid gasses).

## Connecting Load to AC/DC 2-wire Sensor

Refer to the following before using AC or DC 2-wire Proximity Sensors.

### Surge Protection

Although the Proximity Sensor has a surge absorption circuit, if there is any machine that has a large surge current (e.g., a motor or welding machine) near the Proximity Sensor, connect a surge absorber to the machine.

### Leakage Current

When the Proximity Sensor is OFF, the Proximity Sensor has leakage current. Refer to page 17 and page 20 Leakage Current Characteristics. In this case, the load is imposed with a small voltage and the load may not be reset. Before using the Proximity Sensor, make sure that this voltage is less than the load reset voltage. The AC 2-wire Proximity Sensor cannot be connected to any card-lift-off relay (e.g., the G2A) because contact vibration of the relay will be caused by the leakage current and the life of the relay will be shortened.

### Loads with Large Inrush Currents (E2E-X□T□)

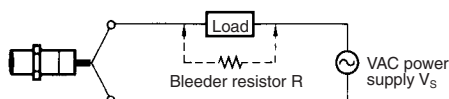
Connecting a load that has a large inrush current (e.g., a lamp or motor) may result in a malfunction due to the inrush current causing a load short-circuit.

## Countermeasures Against Leakage Current

### AC 2-wire Models

Connect a bleeder resistor as the bypass for the leakage current so that the current flowing into the load will be less than the load reset current.

As shown in the following diagram, connect the bleeder resistor so that the current flowing into the Proximity Sensor will be 10 mA minimum and the residual voltage imposed on the load will be less than the load reset voltage.



Refer to the following to calculate the bleeder resistance and the allowable power of the bleeder resistor.

$$R \leq V_S / (10 - I) \text{ (k}\Omega\text{)}$$

$$P > V_S^2 / R \text{ (mW)}$$

P: The allowable power of the bleeder resistor. (The actual power capacity of the bleeder resistor must be at least a few times as large as the allowable power of the bleeder resistor.)

I: Load current (mA)

The following resistors are recommended.

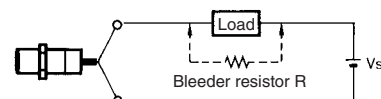
100 VAC (supply voltage): A resistor with a resistance of 10 kΩ maximum and an allowable power of 3 W minimum

200 VAC (supply voltage): A resistor with a resistance of 20 kΩ maximum and an allowable power of 10 W minimum

If these resistors generate excessive heat, use a resistor with a resistance of 10 kΩ maximum and an allowable power of 5 W minimum at 100 VAC and a resistor with a resistance of 20 kΩ maximum and an allowable power of 10 W minimum at 200 VAC instead.

### DC 2-wire Models

Connect a bleeder resistor as the bypass for the leakage current so that the current flowing into the load will be less than the load reset current.



Refer to the following to calculate the bleeder resistance and the allowable power of the bleeder resistor.

$$R \leq V_S / (i_R - i_{OFF}) \text{ (k}\Omega\text{)}$$

$$P > V_S^2 / R \text{ (mW)}$$

P: The allowable power of the bleeder resistor. (The actual power capacity of the bleeder resistor must be at least a few times as large as the allowable power of the bleeder resistor.)

$i_R$ : Leakage current of Sensors (mA)

$i_{OFF}$ : Release current of load (mA)

The following resistors are recommended.

12 VDC (supply voltage): A resistor with a resistance of 15 kΩ maximum and an allowable power of 450 mW minimum

24 VDC (supply voltage): A resistor with a resistance of 30 kΩ maximum and an allowable power of 0.1 W minimum

## Connection to a PLC

### Required Conditions

Connection to a PLC is possible if the specifications of the PLC and the Proximity Sensor satisfy the following conditions. (The meanings of the symbols are given below.)

- The ON voltage of the PLC and the residual voltage of the Proximity Sensor must satisfy the following.  

$$V_{ON} \leq V_{CC} - V_R$$
- The OFF current of the PLC and the leakage current of the Proximity Sensor must satisfy the following.  

$$I_{OFF} \geq I_{leak}$$
 (If the OFF current is not listed in the specifications, take it to be 1.3 mA.)
- The ON current of the PLC and the control output ( $I_{OUT}$ ) of the Proximity Sensor must satisfy the following.  

$$I_{OUT(min)} \leq I_{ON} \leq I_{OUT(max)}$$
 The ON current of the PLC will vary, however, with the power supply voltage and the input impedance used as shown in the following equation.  

$$I_{ON} = (V_{CC} - V_R - V_{PC})/R_{IN}$$

### Example

In this example, the above conditions are checked for when the PLC model is the C200H-ID212, the Proximity Sensor model is the E2E-X7D1-N, and the power supply voltage is 24 V.

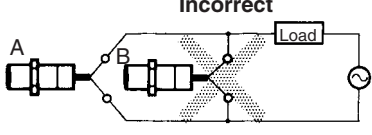
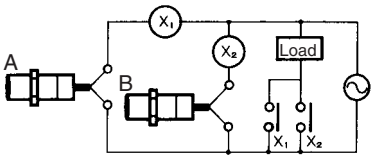
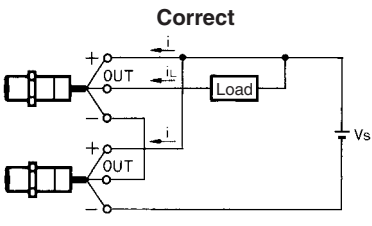
- $V_{ON} (14.4 \text{ V}) \leq V_{CC} (20.4 \text{ V}) - V_R (3 \text{ V}) = 17.4 \text{ V}$ : OK
- $I_{OFF} (1.3 \text{ mA}) \geq I_{leak} (0.8 \text{ mA})$ : OK
- $I_{ON} = [V_{CC} (20.4 \text{ V}) - V_R (3 \text{ V}) - V_{PC} (4 \text{ V})]/R_{IN} (3 \text{ k}\Omega) \approx 4.5 \text{ mA}$   
 Therefore,  
 $I_{OUT(min)} (3 \text{ mA}) \leq I_{ON} (4.5 \text{ mA})$ : OK

$V_{ON}$ : ON voltage of PLC (14.4 V)  
 $I_{ON}$ : ON current of PLC (typ. 7 mA)  
 $I_{OFF}$ : OFF current of PLC (1.3 mA)  
 $R_{IN}$ : Input impedance of PLC (3 k $\Omega$ )  
 $V_{PC}$ : Internal residual voltage of PLC (4 V)  
 $V_R$ : Output residual voltage of Proximity Sensor (3 V)  
 $I_{leak}$ : Leakage current of Proximity Sensor (0.8 mA)  
 $I_{OUT}$ : Control output of Proximity Sensor (3 to 100 mA)  
 $V_{CC}$ : Power supply voltage (PLC: 20.4 to 26.4 V)  
 Values in parentheses are for the following PLC model and Proximity Sensor model.  
 PLC: C200H-ID212  
 Proximity Sensor: E2E-X7D1-N

## ■ Precautions for AC/DC 2-wire Proximity Sensors in Operation

### Connection

Model	Connection type	Method	Description
DC 2-wire	AND (serial connection)	<p style="text-align: center;"><b>Correct</b></p>	<p>The Sensors connected together must satisfy the following conditions.</p> $V_S - N \times V_R \geq \text{Load operating voltage}$ $N: \text{No. of Sensors}$ $V_R: \text{Residual voltage of each Sensor}$ $V_S: \text{Supply voltage}$ <p>If each Proximity Sensor is not supplied with the rated voltage and current, the indicator will not be lit properly or unnecessary pulses may be output for approximately 1 ms.</p>
	OR (parallel connection)	<p style="text-align: center;"><b>Correct</b></p>	<p>The Sensors connected together must satisfy the following conditions.</p> $N \times i \leq \text{Load reset current}$ $N: \text{No. of Sensors}$ $i: \text{Leakage current of each Sensor}$ <p>If the MY Relay, which operates at 24 VDC, is used as a load for example, a maximum of four Proximity Sensors can be connected to the load.</p>
AC 2-wire	AND (serial connection)	<p style="text-align: center;"><b>Incorrect</b></p>	<p>If 100 or 200 VAC is imposed on the Proximity Sensors, <math>V_L</math> (i.e., the voltage imposed on the load) will be obtained from the following.</p> $V_L = V_S - (\text{residual voltage} \times \text{No. of Proximity Sensors}) (V)$ <p>Therefore, if <math>V_L</math> is lower than the load operating voltage, the load will not operate.</p> <p>A maximum of three Proximity Sensors can be connected in series provided that the supply voltage is 100 V minimum.</p>
		<p style="text-align: center;"><b>Correct</b></p>	

Model	Connection type	Method	Description
AC 2-wire	OR (parallel connection)	<p><b>Incorrect</b></p>  <p><b>Correct</b></p>  <p>VAC power supply <math>V_s</math></p>	<p>In principle, more than two Proximity Sensors cannot be connected in parallel.</p> <p>Provided that Proximity Sensor A does not operate with Proximity Sensor B simultaneously and there is no need to keep the load operating continuously, the Proximity Sensors can be connected in parallel. In this case, however, due to the total leakage current of the Proximity Sensors, the load may not reset properly.</p> <p>It is not possible to keep the load operating continuously with Proximity Sensors A and B in simultaneous operation to sense sensing objects due to the following reason.</p> <p>When Proximity Sensor A is ON, the voltage imposed on Proximity Sensor A will drop to approximately 10 V and the load current flows into Proximity Sensor A, and when one of the sensing objects is close to Proximity Sensor B, Proximity Sensor B will not operate because the voltage imposed on Proximity Sensor B is 10 V, which is too low. When Proximity Sensor A is OFF, the voltage imposed on Proximity Sensor B will reach the supply voltage and Proximity Sensor B will be ON. Then, Proximity Sensor A as well as Proximity Sensor B will be OFF for approximately 10 ms, which resets the load for an instant. To prevent the instantaneous resetting of the load, use a relay as shown on the left.</p>
DC 3-wire	AND (serial connection)	<p><b>Correct</b></p>  <p><math>V_s</math></p>	<p>The Sensors connected together must satisfy the following conditions.</p> <p><math>i_L + (N - 1) \times i \leq</math> Upper-limit of control output of each Sensor</p> <p><math>V_s - N \times V_R \geq</math> Load operating voltage</p> <p>N: No. of Sensors</p> <p><math>V_R</math>: Residual voltage of each Sensor</p> <p><math>V_s</math>: Supply voltage</p> <p>i: Current consumption of the Sensor</p> <p><math>i_L</math>: Load current</p> <p>If the MY Relay, which operates at 24 VDC, is used as a load for example, a maximum of two Proximity Sensors can be connected to the load.</p>

# Dimensions

Note: All units are in millimeters unless otherwise indicated.

## E2E

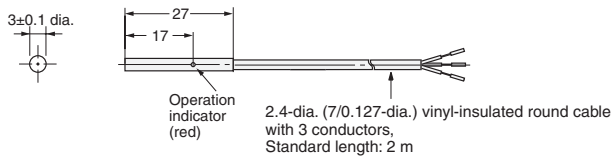
Model			DC 2-wire		DC 3-wire		AC 2-wire		AC/DC 2-wire	
			Model No.	Figure No.	Model No.	Figure No.	Model No.	Figure No.	Model No.	Figure No.
Pre-wired	Shielded	3 dia.	---	---	E2E-CR6□	1	---	---	---	---
		4 dia.	---	---	E2E-CR8□□	2	---	---	---	---
		M5	---	---	E2E-X1□□	4	---	---	---	---
		5.4 dia.	---	---	E2E-C1□□	3	---	---	---	---
		M8	E2E-X2D□-N	5	E2E-X1R5E□/F□	5	E2E-X1R5Y□	7	---	---
		M12	E2E-X3D□-N	9	E2E-X2E□/F□	9	E2E-X2Y□	11	E2E-X3T1	12
		M18	E2E-X7D□-N	14	E2E-X5E□/F□	14	E2E-X5Y□	12	E2E-X7T1	13
	M30	E2E-X10D□-N	16	E2E-X10E□/F□	16	E2E-X10Y□	16	E2E-X10T1	15	
	Unshielded	M8	E2E-X4MD□	6	E2E-X2ME□/F□	6	E2E-X2MY□	8	---	---
		M12	E2E-X8MD□	10	E2E-X5ME□/F□	10	E2E-X5MY□	12	---	---
		M18	E2E-X14MD□	15	E2E-X10ME□/F□	15	E2E-X10MY□	15	---	---
		M30	E2E-X20MD□	17	E2E-X18ME□/F□	17	E2E-X18MY□	17	---	---
	Connector (M12)	Shielded	M8	E2E-X2D□-M1(G)	18	E2E-X1R5E□-M1/F□-M1	18	---	---	---
M12			E2E-X3D□-M1(G)	20	E2E-X2E□-M1/F□-M1	20	E2E-X2Y□-M1	22	---	---
M18			E2E-X7D□-M1(G)	24	E2E-X5E□-M1/F□-M1	24	E2E-X5Y□-M1	24	---	---
M30			E2E-X10D□-M1(G)	26	E2E-X10E□-M1/F□-M1	26	E2E-X10Y□-M1	26	---	---
Unshielded		M8	E2E-X4MD□-M1(G)	19	E2E-X2ME□-M1/F□-M1	19	---	---	---	---
		M12	E2E-X8MD□-M1(G)	21	E2E-X5ME□-M1/F□-M1	21	E2E-X5MY□-M1	23	---	---
		M18	E2E-X14MD□-M1(G)	25	E2E-X10ME□-M1/F□-M1	25	E2E-X10MY□-M1	25	---	---
M30	E2E-X20MD□-M1(G)	27	E2E-X18ME□-M1/F□-M1	27	E2E-X18MY□-M1	27	---	---		
Connector (M8-3 pin)	Shielded	4 dia.	---	---	E2E-CR8□□-M5	36	---	---	---	---
		M5	---	---	E2E-X1□□-M5	37	---	---	---	---
Connector (M8)	Shielded	M8	E2E-X2D□-M3G	28	E2E-X1R5E□-M3/F□-M3	28	---	---	---	---
	Unshielded		E2E-X4MD□-M3G	29	E2E-X2ME□-M3/F□-M3	29	---	---	---	---
Pre-wired connector	Shielded	M12	E2E-X3D1-M1GJ	30	---	---	---	---	---	---
		M18	E2E-X7D1-M1GJ	32	---	---	---	---	---	---
		M30	E2E-X10D1-M1GJ	34	---	---	---	---	---	---
	Unshielded	M12	E2E-X8MD1-M1GJ	31	---	---	---	---	---	---
		M18	E2E-X14MD1-M1GJ	33	---	---	---	---	---	---
M30	E2E-X20MD1-M1GJ	35	---	---	---	---	---	---		
Pre-wired connector (no polarity)	Shielded	M12	E2E-X3D1-M1J-T	30	---	---	---	---	---	---
		M18	E2E-X7D1-M1J-T	32	---	---	---	---	---	---
		M30	E2E-X10D1-M1J-T	34	---	---	---	---	---	---

Note 1. Two clamping nuts and one toothed washer are provided with M8 to M30 Models.

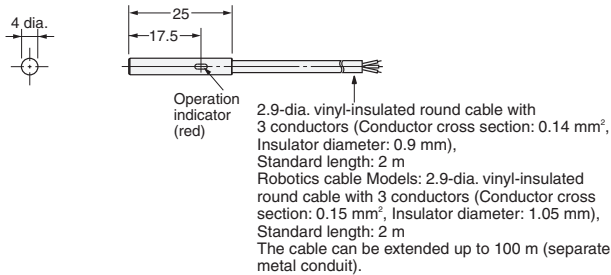
2. The model numbers of Pre-wired M8 to M30 Models are laser-marked on the milled section and cable section.

**Pre-wired Models (Shielded)**

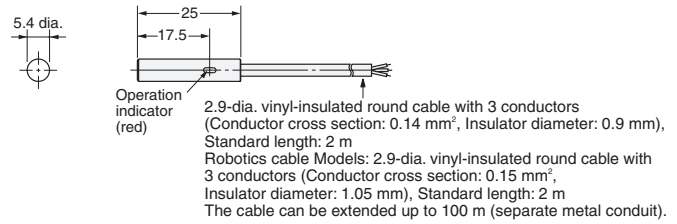
**Fig. 1: E2E-CR6□□**



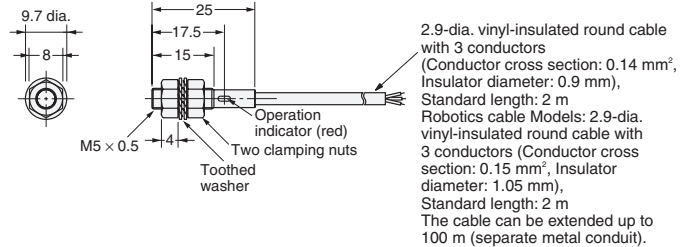
**Fig. 2: E2E-CR8□□**



**Fig. 3: E2E-C1□□**

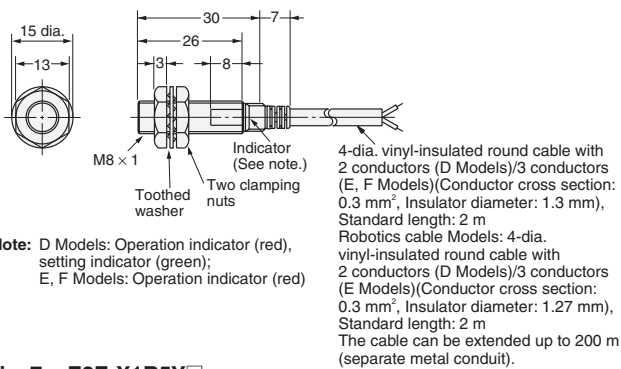


**Fig. 4: E2E-X1□□**



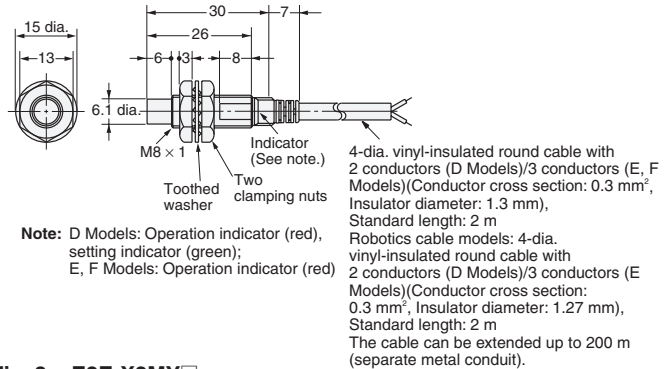
**Pre-wired Models (Shielded)**

**Fig. 5: E2E-X2D□-N  
E2E-X1R5E□/F□**

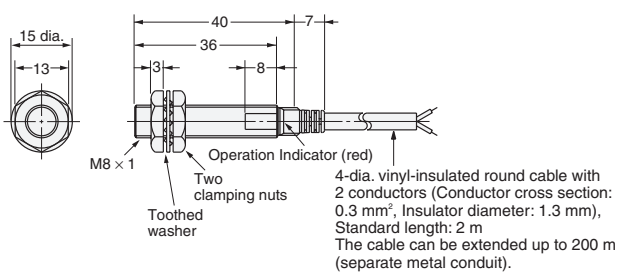


**Pre-wired Models (Unshielded)**

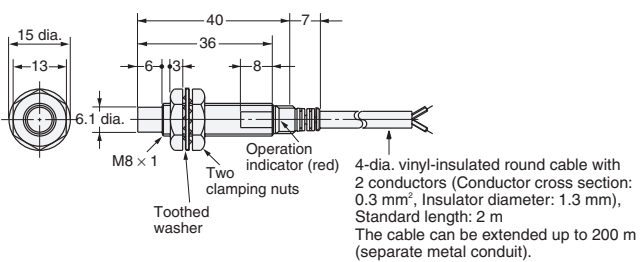
**Fig. 6: E2E-X4MD□  
E2E-X2ME□/F□**



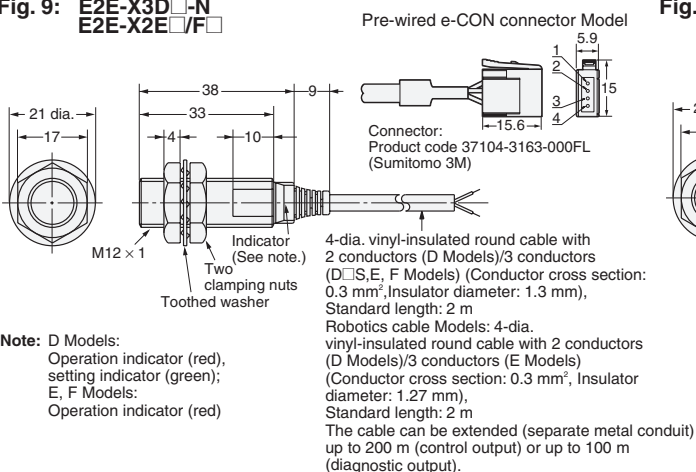
**Fig. 7: E2E-X1R5Y□**



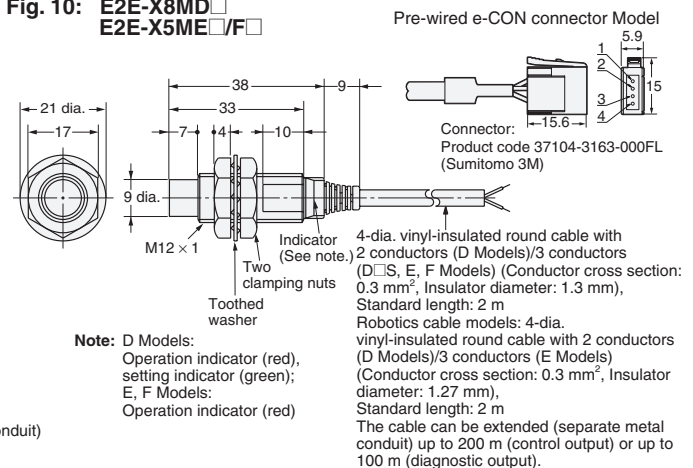
**Fig. 8: E2E-X2MY□**



**Fig. 9: E2E-X3D□-N  
E2E-X2E□/F□**



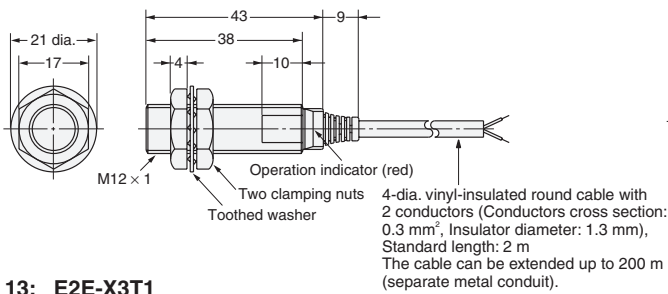
**Fig. 10: E2E-X8MD□  
E2E-X5ME□/F□**





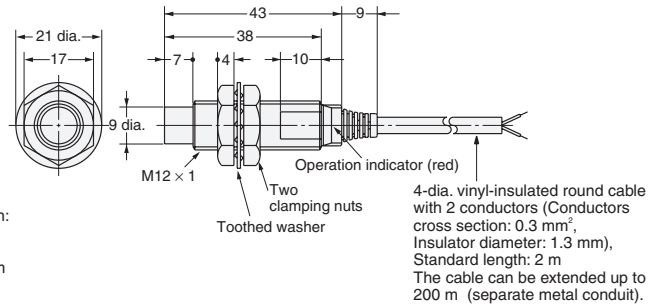
**Pre-wired Models (Shielded)**

**Fig. 11: E2E-X2Y□**

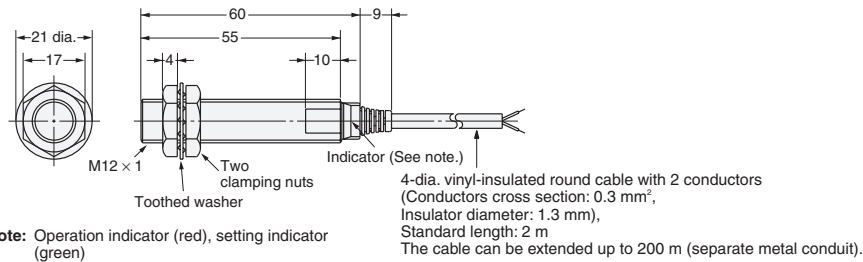


**Pre-wired Models (Unshielded)**

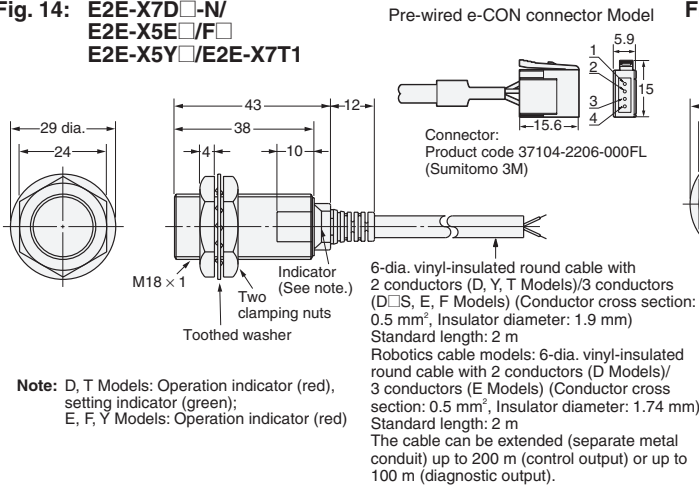
**Fig. 12: E2E-X5MY□**



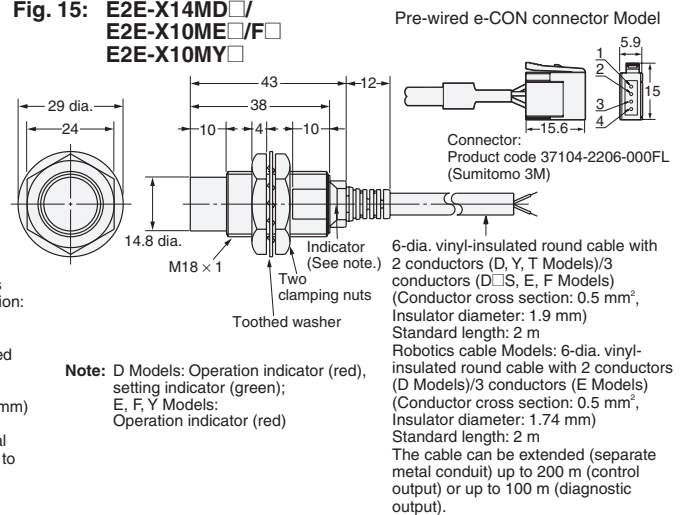
**Fig. 13: E2E-X3T1**



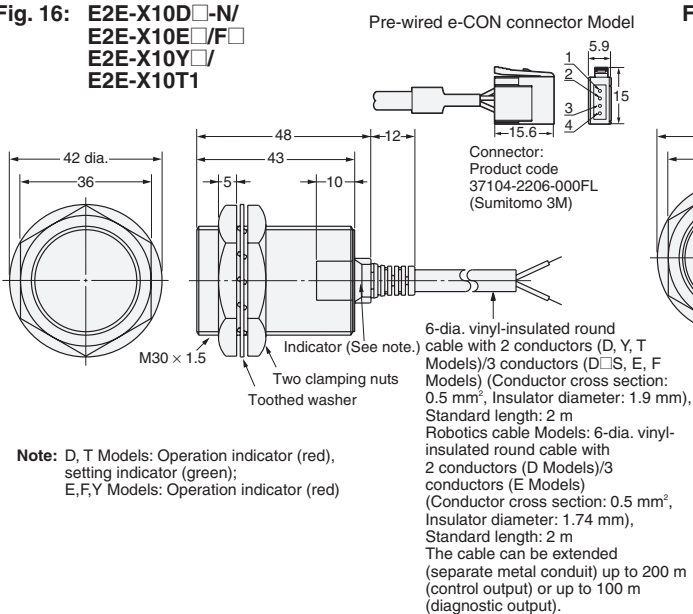
**Fig. 14: E2E-X7D□-N/  
E2E-X5E□/F□  
E2E-X5Y□/E2E-X7T1**



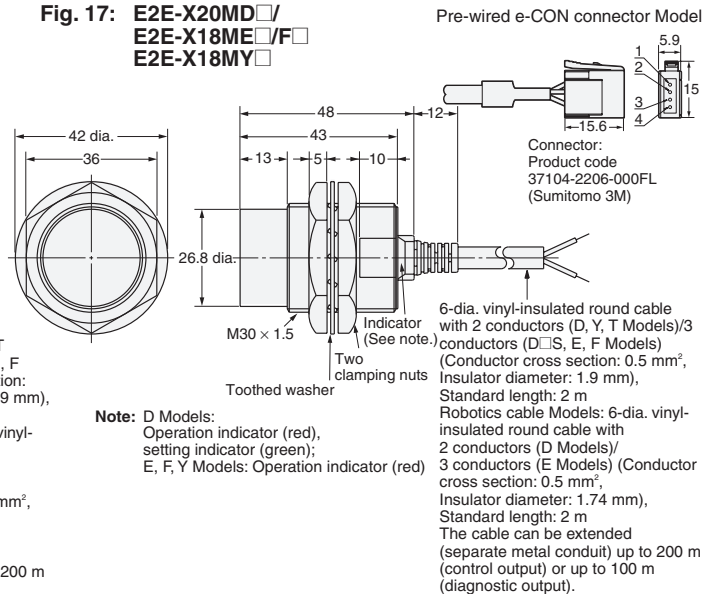
**Fig. 15: E2E-X14MD□/  
E2E-X10ME□/F□  
E2E-X10MY□**



**Fig. 16: E2E-X10D□-N/  
E2E-X10E□/F□  
E2E-X10Y□/  
E2E-X10T1**

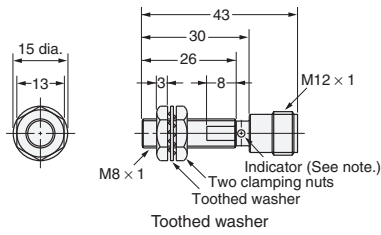


**Fig. 17: E2E-X20MD□/  
E2E-X18ME□/F□  
E2E-X18MY□**



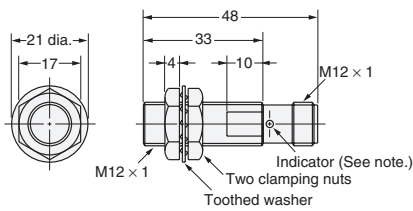
**M12 Connector Models  
(Shielded)**

**Fig. 18: E2E-X2D□-M1(G)  
E2E-X1R5E□-M1/F□-M1**



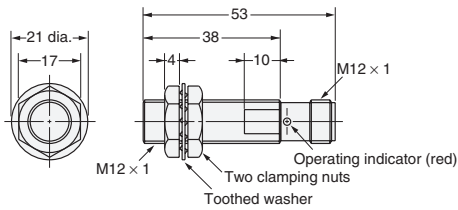
**Note:** D Models: Operation indicator (red), setting indicator (green)  
E, F Model: Operation indicator (red)

**Fig. 20: E2E-X3D□-M1(G)  
E2E-X2E□-M1/F□-M1**

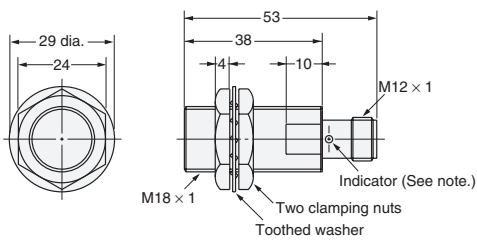


**Note:** D Models: Operation indicator (red), setting indicator (green)  
E, F Model: Operation indicator (red)

**Fig. 22: E2E-X2Y□-M1**

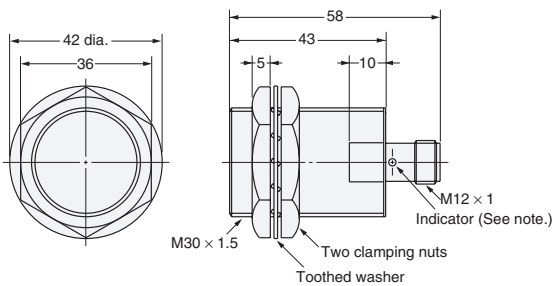


**Fig. 24: E2E-X7D□-M1(G)/E2E-X5E□-M1/F□-M1  
E2E-X5Y□-M1**



**Note:** D Models: Operation indicator (red), setting indicator (green)  
E, F, Y Model: Operation indicator (red)

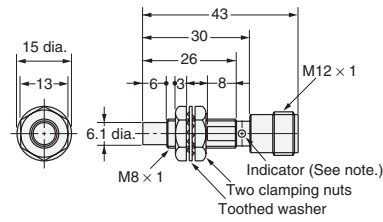
**Fig. 26: E2E-X10D□-M1(G)/E2E-X10E□-M1/F□-M1  
E2E-X10Y□-M1**



**Note:** D Models: Operation indicator (red), setting indicator (green)  
E, F, Y Model: Operation indicator (red)

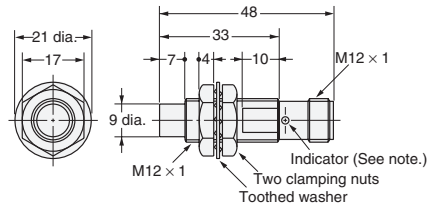
**M12 Connector Models  
(Unshielded)**

**Fig. 19: E2E-X4MD□-M1(G)  
E2E-X2ME□-M1/F□-M1**



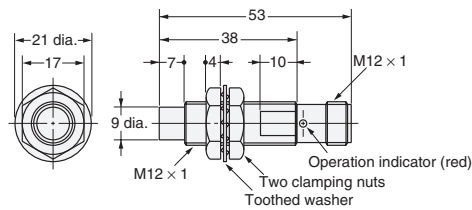
**Note:** D Models: Operation indicator (red), setting indicator (green)  
E, F Model: Operation indicator (red)

**Fig. 21: E2E-X8MD□-M1(G)  
E2E-X5ME□-M1/F□-M1**

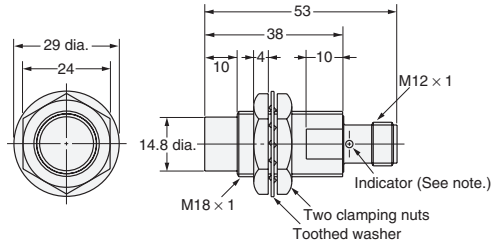


**Note:** D Models: Operation indicator (red), setting indicator (green)  
E, F Model: Operation indicator (red)

**Fig. 23: E2E-X5MY□-M1**

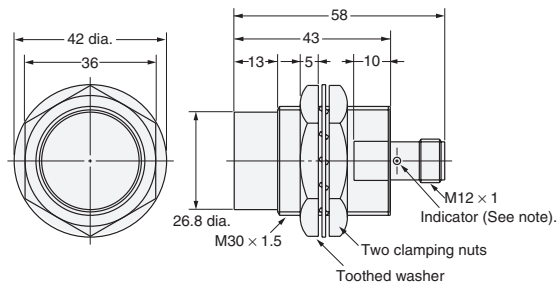


**Fig. 25: E2E-X14MD□-M1(G)/E2E-X10ME□-M1/F□-M1  
E2E-X10MY□-M1**



**Note:** D Models: Operation indicator (red), setting indicator (green)  
E, F, Y Model: Operation indicator (red)

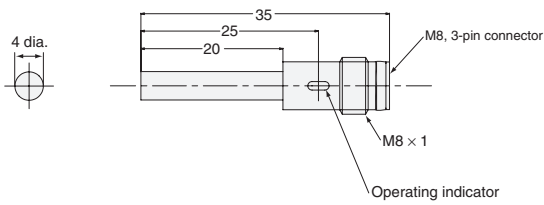
**Fig. 27: E2E-X20MD□-M1(G)/E2E-X18ME□-M1/F□-M1  
E2E-X18MY□-M1**



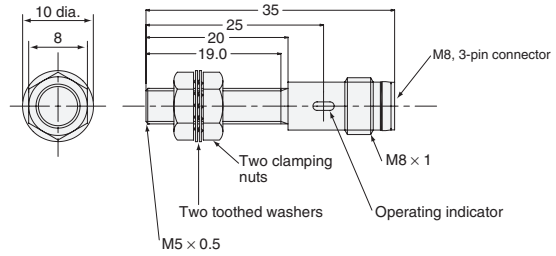
**Note:** D Models: Operation indicator (red), setting indicator (green)  
E, F, Y Model: Operation indicator (red)

**M8 (3 pin) Connector Models (Shielded)**

**Fig. 36: E2E-CR8□□-M5**

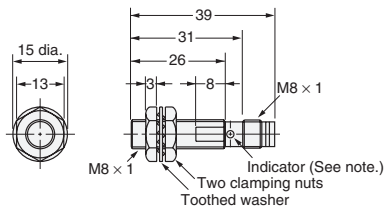


**Fig. 37: E2E-X1□□-M5**



**M8 Connector Models (Shielded)**

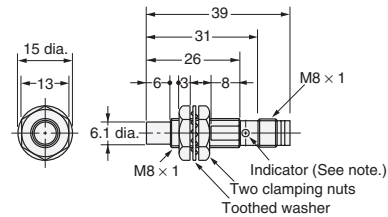
**Fig. 28: E2E-X2D□-M3G/E2E-X1R5E□-M3/F□-M3**



**Note:** D Models: Operation indicator (red), setting indicator (green)  
E, F Model: Operation indicator (red)

**M8 Connector Models (Unshielded)**

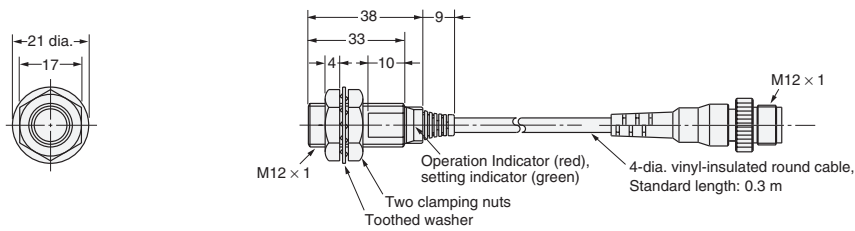
**Fig. 29: E2E-X4MD□-M3G/E2E-X2ME□-M3/F□-M3**



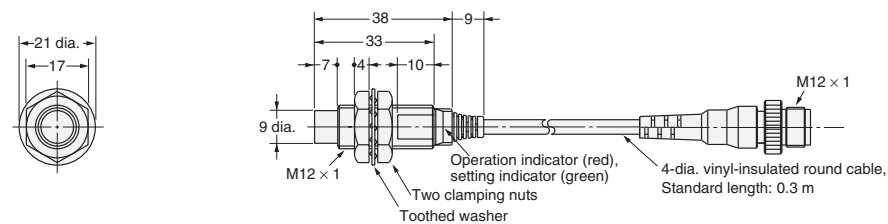
**Note:** D Models: Operation indicator (red), setting indicator (green)  
E, F Model: Operation indicator (red)

**Pre-wired M12 Connector Models**

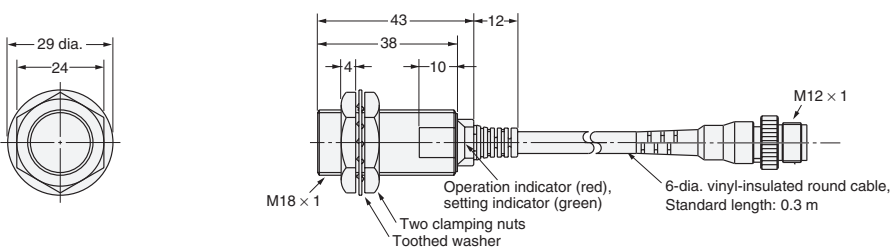
**Fig. 30: E2E-X3D1-M1GJ  
E2E-X3D1-M1J-T**



**Fig. 31: E2E-X8MD1-M1GJ**



**Fig. 32: E2E-X7D1-M1GJ  
E2E-X7D1-M1J-T**



Pre-wired M12 Connector Models

Fig. 33: E2E-X14MD1-M1GJ

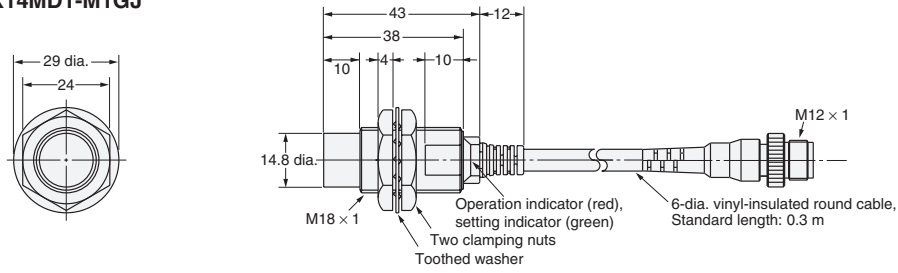


Fig. 34: E2E-X10D1-M1GJ  
E2E-X10D1-M1J-T

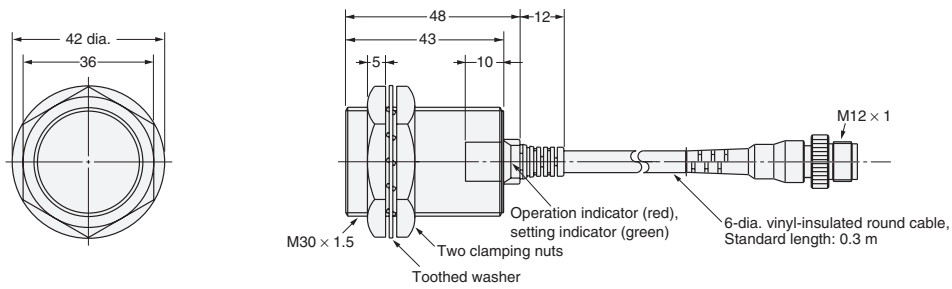
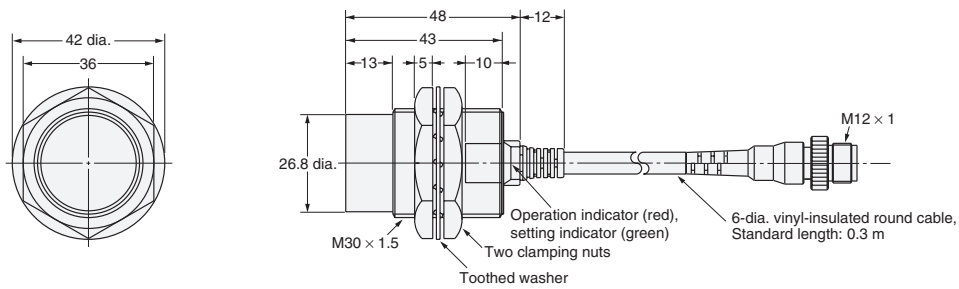
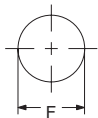


Fig. 35: E2E-X20MD1-M1GJ



Mounting Holes

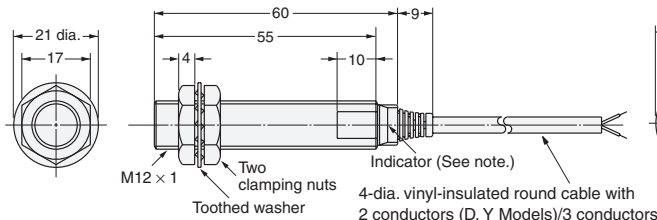


Dimensions	3 dia.	4 dia.	M5	5.4 dia.	M8	M12	M18	M30
F (mm)	3.3 <sup>+0.3/0</sup> dia.	4.2 <sup>+0.5/0</sup> dia.	5.5 <sup>+0.5/0</sup> dia.	5.7 <sup>+0.5/0</sup> dia.	8.5 <sup>+0.5/0</sup> dia.	12.5 <sup>+0.5/0</sup> dia.	18.5 <sup>+0.5/0</sup> dia.	30.5 <sup>+0.5/0</sup> dia.

# E2E2

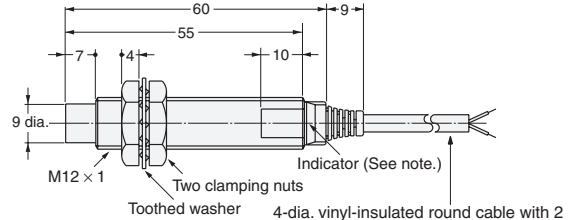
## Pre-wired Models

E2E2-X3D □  
E2E2-X2 □ □



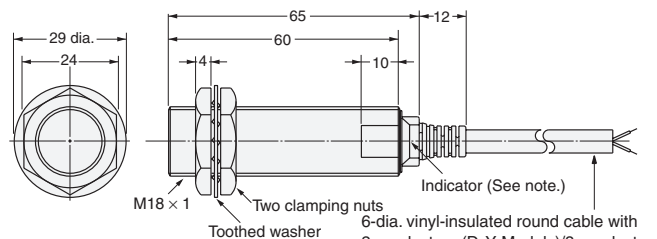
**Note:** D Models: Operation indicator (red), setting indicator (green)  
B, C, Y Model: Operation indicator (red)  
4-dia. vinyl-insulated round cable with 2 conductors (D, Y Models)/3 conductors (B, C Models) (Conductor cross section: 0.3 mm<sup>2</sup>, Insulator diameter: 1.3 mm), Standard length: 2 m  
The cable can be extended up to 200 m (separate metal conduit).

E2E2-X8MD □  
E2E2-X5M □ □



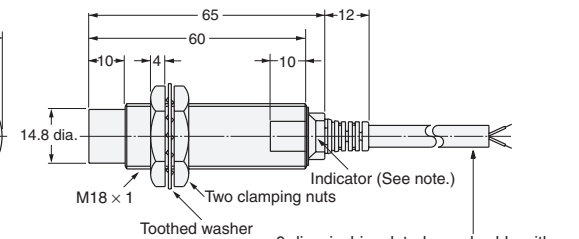
**Note:** D Models: Operation indicator (red), setting indicator (green)  
B, C, Y Model: Operation indicator (red)  
4-dia. vinyl-insulated round cable with 2 conductors (D, Y Models)/3 conductors (B, C Models) (Conductor cross section: 0.3 mm<sup>2</sup>, Insulator diameter: 1.3 mm), Standard length: 2 m  
The cable can be extended up to 200 m (separate metal conduit).

E2E2-X7D □  
E2E2-X5 □ □



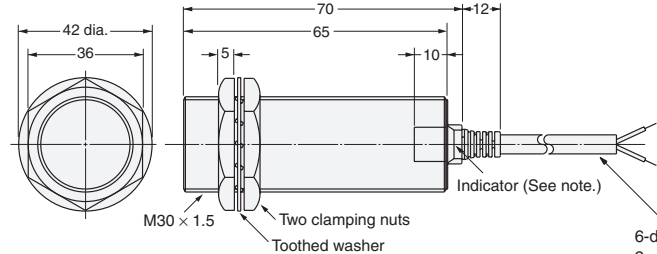
**Note:** D Models: Operation indicator (red), setting indicator (green)  
B, C, Y Model: Operation indicator (red)  
6-dia. vinyl-insulated round cable with 2 conductors (D, Y Models)/3 conductors (B, C Models) (Conductor cross section: 0.5 mm<sup>2</sup>, Insulator diameter: 1.9 mm), Standard length: 2 m  
The cable can be extended up to 200 m (separate metal conduit).

E2E2-X14MD □  
E2E2-X10M □ □



**Note:** D Models: Operation indicator (red), setting indicator (green)  
B, C, Y Model: Operation indicator (red)  
6-dia. vinyl-insulated round cable with 2 conductors (D, Y Models)/3 conductors (B, C Models) (Conductor cross section: 0.5 mm<sup>2</sup>, Insulator diameter: 1.9 mm), Standard length: 2 m  
The cable can be extended up to 200 m (separate metal conduit).

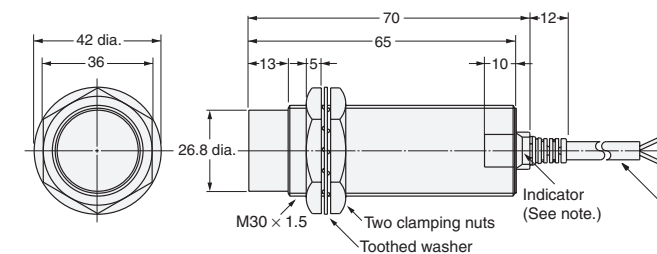
E2E2-X10D □ □  
E2E2-X10 □ □



**Note:** D Models: Operation indicator (red), setting indicator (green)  
B, C, Y Model: Operation indicator (red)

6-dia. vinyl-insulated round cable with 2 conductors (D, Y Models)/3 conductors (B, C Models) (Conductor cross section: 0.5 mm<sup>2</sup>, Insulator diameter: 1.9 mm), Standard length: 2 m  
The cable can be extended up to 200 m (separate metal conduit).

E2E2-X20MD □  
E2E2-X18M □ □

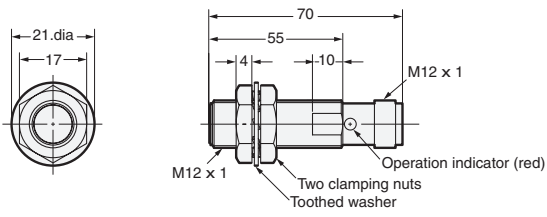


**Note:** D Models: Operation indicator (red), setting indicator (green)  
B, C, Y Model: Operation indicator (red)

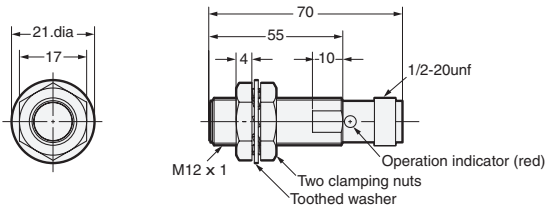
6-dia. vinyl-insulated round cable with 2 conductors (D, Y Models)/3 conductors (B, C Models) (Conductor cross section: 0.5 mm<sup>2</sup>, Insulator diameter: 1.9 mm), Standard length: 2 m  
The cable can be extended up to 200 m (separate metal conduit).

**Connector Models  
(Shielded)**

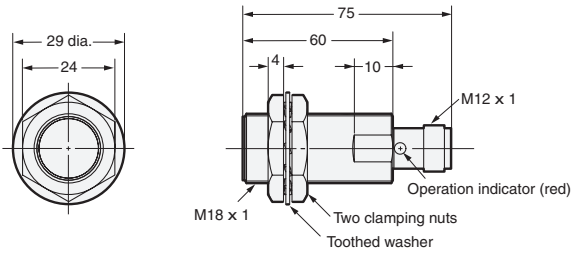
**E2E2-X2C□-M1/B□-M1**



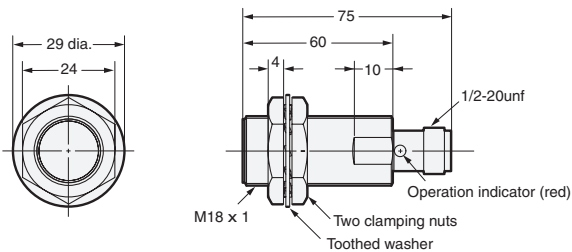
**E2E2-X2Y□-M4**



**E2E2-X5C□-M1/B□-M1**

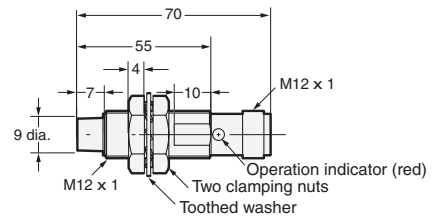


**E2E2-X5Y□-M4**

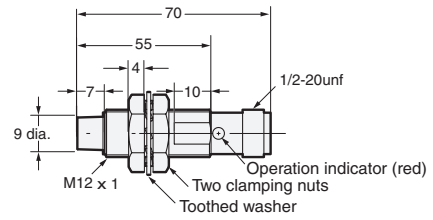


**Connector Models  
(Unshielded)**

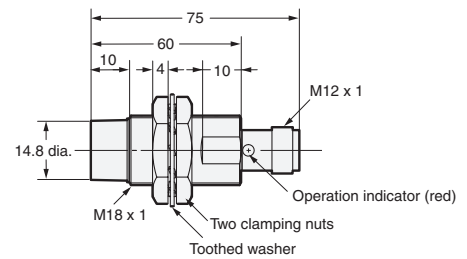
**E2E2-X5MC□-M1/B□-M1**



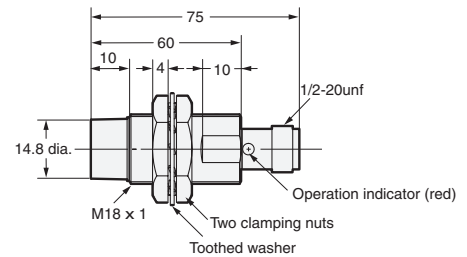
**E2E2-X5MY□-M4**



**E2E2-X10MC□-M1/B□-M1**

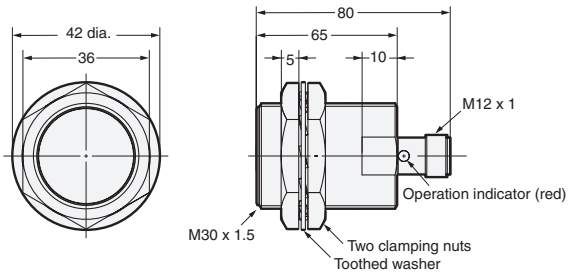


**E2E2-X10MY□-M4**



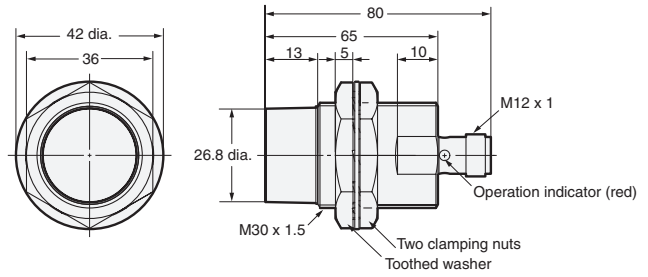
**Connector Models  
(Shielded)**

**E2E2-X10C□-M1/B□-M1**

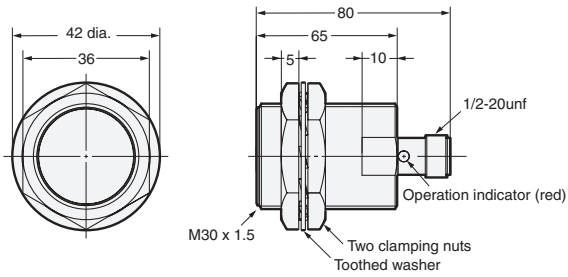


**Connector Models  
(Unshielded)**

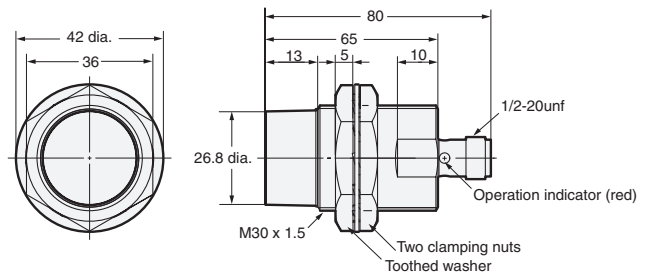
**E2E2-X18MC□-M1/B□-M1**



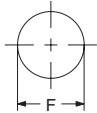
**E2E2-X10Y□-M4**



**E2E2-X18MY□-M4**



**Mounting Holes**



Dimensions	M12	M18	M30
F (mm)	12.5 <sup>+0.5</sup> <sub>0</sub> dia.	18.5 <sup>+0.5</sup> <sub>0</sub> dia.	30.5 <sup>+0.5</sup> <sub>0</sub> dia.

**WARRANTY**

OMRON's exclusive warranty is that the products are free from defects in materials and workmanship for a period of one year (or other period if specified) from date of sale by OMRON.

OMRON MAKES NO WARRANTY OR REPRESENTATION, EXPRESS OR IMPLIED, REGARDING NON-INFRINGEMENT, MERCHANTABILITY, OR FITNESS FOR PARTICULAR PURPOSE OF THE PRODUCTS. ANY BUYER OR USER ACKNOWLEDGES THAT THE BUYER OR USER ALONE HAS DETERMINED THAT THE PRODUCTS WILL SUITABLY MEET THE REQUIREMENTS OF THEIR INTENDED USE. OMRON DISCLAIMS ALL OTHER WARRANTIES, EXPRESS OR IMPLIED.

**LIMITATIONS OF LIABILITY**

OMRON SHALL NOT BE RESPONSIBLE FOR SPECIAL, INDIRECT, OR CONSEQUENTIAL DAMAGES, LOSS OF PROFITS OR COMMERCIAL LOSS IN ANY WAY CONNECTED WITH THE PRODUCTS, WHETHER SUCH CLAIM IS BASED ON CONTRACT, WARRANTY, NEGLIGENCE, OR STRICT LIABILITY.

In no event shall responsibility of OMRON for any act exceed the individual price of the product on which liability is asserted.

IN NO EVENT SHALL OMRON BE RESPONSIBLE FOR WARRANTY, REPAIR, OR OTHER CLAIMS REGARDING THE PRODUCTS UNLESS OMRON'S ANALYSIS CONFIRMS THAT THE PRODUCTS WERE PROPERLY HANDLED, STORED, INSTALLED, AND MAINTAINED AND NOT SUBJECT TO CONTAMINATION, ABUSE, MISUSE, OR INAPPROPRIATE MODIFICATION OR REPAIR.

**SUITABILITY FOR USE**

THE PRODUCTS CONTAINED IN THIS DOCUMENT ARE NOT SAFETY RATED. THEY ARE NOT DESIGNED OR RATED FOR ENSURING SAFETY OF PERSONS, AND SHOULD NOT BE RELIED UPON AS A SAFETY COMPONENT OR PROTECTIVE DEVICE FOR SUCH PURPOSES. Please refer to separate catalogs for OMRON's safety rated products.

OMRON shall not be responsible for conformity with any standards, codes, or regulations that apply to the combination of products in the customer's application or use of the product.

At the customer's request, OMRON will provide applicable third party certification documents identifying ratings and limitations of use that apply to the products. This information by itself is not sufficient for a complete determination of the suitability of the products in combination with the end product, machine, system, or other application or use.

The following are some examples of applications for which particular attention must be given. This is not intended to be an exhaustive list of all possible uses of the products, nor is it intended to imply that the uses listed may be suitable for the products:

- Outdoor use, uses involving potential chemical contamination or electrical interference, or conditions or uses not described in this document.
- Nuclear energy control systems, combustion systems, railroad systems, aviation systems, medical equipment, amusement machines, vehicles, safety equipment, and installations subject to separate industry or government regulations.
- Systems, machines, and equipment that could present a risk to life or property.

Please know and observe all prohibitions of use applicable to the products.

NEVER USE THE PRODUCTS FOR AN APPLICATION INVOLVING SERIOUS RISK TO LIFE OR PROPERTY WITHOUT ENSURING THAT THE SYSTEM AS A WHOLE HAS BEEN DESIGNED TO ADDRESS THE RISKS, AND THAT THE OMRON PRODUCT IS PROPERLY RATED AND INSTALLED FOR THE INTENDED USE WITHIN THE OVERALL EQUIPMENT OR SYSTEM.

**PERFORMANCE DATA**

Performance data given in this document is provided as a guide for the user in determining suitability and does not constitute a warranty. It may represent the result of OMRON's test conditions, and the users must correlate it to actual application requirements. Actual performance is subject to the OMRON Warranty and Limitations of Liability.

**CHANGE IN SPECIFICATIONS**

Product specifications and accessories may be changed at any time based on improvements and other reasons.

It is our practice to change model numbers when published ratings or features are changed, or when significant construction changes are made. However, some specifications of the product may be changed without any notice. When in doubt, special model numbers may be assigned to fix or establish key specifications for your application on your request. Please consult with your OMRON representative at any time to confirm actual specifications of purchased products.

**DIMENSIONS AND WEIGHTS**

Dimensions and weights are nominal and are not to be used for manufacturing purposes, even when tolerances are shown.

**ERRORS AND OMISSIONS**

The information in this document has been carefully checked and is believed to be accurate; however, no responsibility is assumed for clerical, typographical, or proofreading errors, or omissions.

**PROGRAMMABLE PRODUCTS**

OMRON shall not be responsible for the user's programming of a programmable product, or any consequence thereof.

**ALL DIMENSIONS SHOWN ARE IN MILLIMETERS.**

To convert millimeters into inches, multiply by 0.03937. To convert grams into ounces, multiply by 0.03527.

**OMRON Corporation**  
Industrial Automation Company  
Sensing Devices Division H.Q.  
Industrial Sensors Division

Shiokoji Horikawa, Shimogyo-ku,  
Kyoto, 600-8530 Japan  
Tel: (81)75-344-7022/Fax: (81)75-344-7107

**Regional Headquarters**

**OMRON EUROPE B.V.**  
Sensor Business Unit  
Carl-Benz-Str. 4, D-71154 Nufringen,  
Germany  
Tel: (49) 7032-811-0/Fax: (49) 7032-811-199

**OMRON ELECTRONICS LLC**  
One Commerce Drive Schaumburg,  
IL 60173-5302 U.S.A.  
Tel: (1) 847-843-7900/Fax: (1) 847-843-7787

**OMRON ASIA PACIFIC PTE. LTD.**  
No. 438A Alexandra Road # 05-05/08 (Lobby 2),  
Alexandra Technopark, Singapore 119967  
Tel: (65) 6835-3011/Fax: (65) 6835-2711

**OMRON (CHINA) CO., LTD.**  
Room 2211, Bank of China Tower,  
200 Yin Cheng Zhong Road,  
PuDong New Area, Shanghai, 200120, China  
Tel: (86) 21-5037-2222/Fax: (86) 21-5037-2200

**Authorized Distributor:**

© OMRON Corporation 2008 All Rights Reserved.  
In the interest of product improvement,  
specifications are subject to change without notice.

**CSM\_E2E\_E2E2\_DS\_E\_1\_1**  
Cat. No. D058-E1

Printed in Japan  
0508