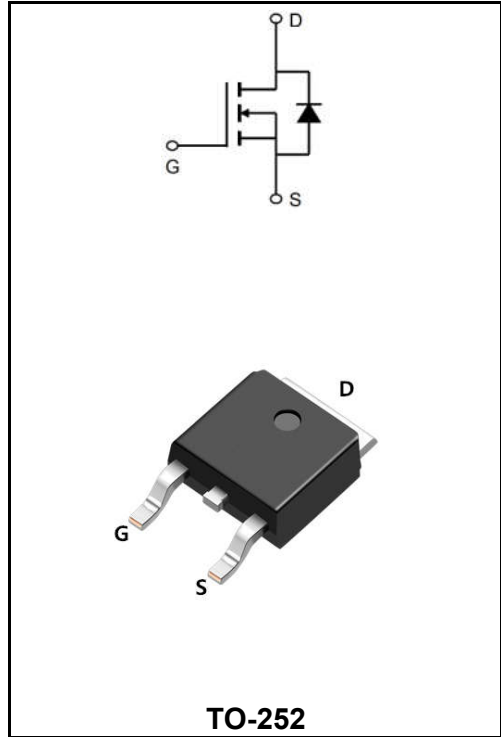


**30V N-CHANNEL ENHANCEMENT MODE MOSFET**

**MAIN CHARACTERISTICS**

$I_D$	60A
$V_{DSS}$	30V
$R_{DS(on)-typ}(@V_{GS}=10V)$	< 8.5mΩ (Type:6.0 mΩ)



**Application**

- ◆VBUS
- ◆Wireless impact
- ◆Mobile phone fast charging



**Product Specification Classification**

Part Number	Package	Marking	Pack
YFW60N03AD	TO-252	YFW 60N03AD XXXXX	2500PCS/Tape

**Maximum Ratings at Tc=25°C unless otherwise specified**

Characteristics	Symbols	Value	Units
Drain-Source Voltage	$V_{DS}$	30	V
Gate - Source Voltage	$V_{GS}$	±20	V
Continuous Drain Current, $V_{GS}$ @ 10V <sup>1</sup> @T <sub>c</sub> =25°C	$I_D$	60	A
Continuous Drain Current, $V_{GS}$ @ 10V <sup>1</sup> @T <sub>c</sub> =100°C	$I_D$	40	A
Pulsed Drain Current <sup>2</sup>	$I_{DM}$	92	A
Single Pulse Avalanche Energy <sup>3</sup>	$E_{AS}$	57.8	mJ
Avalanche Current	$I_{AS}$	34	A
Total Power Dissipation <sup>4</sup> @T <sub>c</sub> =25°C	$P_D$	29	W
Storage Temperature Range	$T_{STG}$	-55 to +150	°C
Operating Junction Temperature Range	$T_J$	-55 to +150	°C
Thermal Resistance, Junction-to-Ambient <sup>1</sup>	$R_{θJA}$	62.5	°C/W
Thermal Resistance Junction-Case <sup>1</sup>	$R_{θJC}$	4.32	°C/W

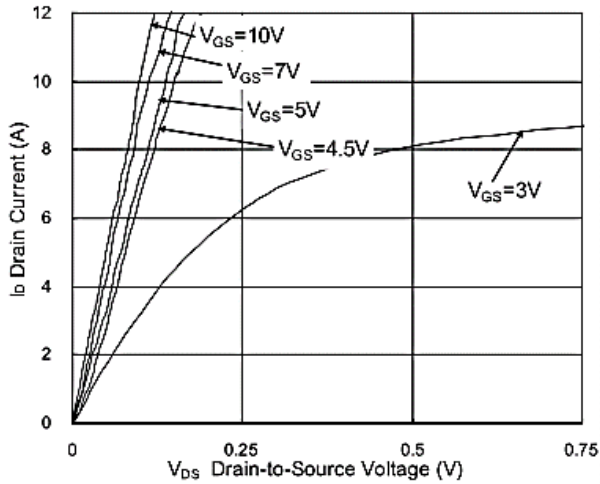
**Maximum Ratings at Tc=25°C unless otherwise specified**

Characteristics	Test Condition	Symbols	Min	Typ	Max	Units
Drain-Source Breakdown Voltage	$V_{GS}=0V, I_D=250\mu A$	$BV_{DSS}$	30	33	-	V
Static Drain-Source On-Resistance <sup>2</sup>	$V_{GS}=10V, I_D=12A$	$R_{DS(ON)}$	-	6.0	8.5	mΩ
	$V_{GS}=4.5V, I_D=10A$		-	8.5	13	
Gate -Threshold Voltage	$V_{DS}=V_{GS}, I_D=250\mu A$	$V_{GS(th)}$	1.0	1.6	2.5	V
$V_{GS(th)}$ Temperature Coefficient		$\Delta V_{GS(th)}$	-	-5.8	-	mV/°C
Drain -Source Leakage Current	$V_{DS}=24V, V_{GS}=0V, T_J=25^\circ C$	$I_{DSS}$	-	-	1	μA
	$V_{DS}=24V, V_{GS}=0V, T_J=55^\circ C$		-	-	5	
Gate-Source Leakage Current	$V_{GS}=\pm 20V, V_{DS}=0V$	$I_{GSS}$	-	-	±100	nA
Forward Transconductance	$V_{DS}=5V, I_D=15A$	$g_{FS}$	-	9.8	-	S
Gate Resistance	$V_{DS}=0V, V_{GS}=0V, f=1MHz$	$R_g$	-	1.7	-	Ω
Total Gate Charge(4.5V)	$V_{DS}=20V$ $V_{GS}=4.5V$ $I_D=12A$	$Q_g$	-	12.8	-	nC
Gate-Source Charge		$Q_{gs}$	-	3.3	-	
Gate-Drain Charge		$Q_{gd}$	-	6.5	-	
Turn-on delay time	$V_{DD}=12V$ $V_{GS}=10V$ $R_G=3.3\Omega$ $I_D=5A$	$t_{d(on)}$	-	4.5	-	ns
Rise Time		$T_r$	-	10.8	-	
Turn-Off Delay Time		$t_{d(OFF)}$	-	25.5	-	
Fall Time		$t_f$	-	9.6	-	
Input Capacitance	$V_{DS}=15V$ $V_{GS}=0V$ $f=1.0MHz$	$C_{iss}$	-	1317	-	pF
Output Capacitance		$C_{oss}$	-	163	-	
Reverse Transfer Capacitance		$C_{rss}$	-	131	-	
Continuous Source Current <sup>1,5</sup>	$V_G=V_D=0V, \text{ Force Current}$	$I_S$	-	-	46	A
Pulsed Source Current <sup>2,5</sup>		$I_{SM}$	-	-	92	A
Diode Forward Voltage <sup>2</sup>	$V_{GS}=0V, I_S=1A, T_J=25^\circ C$	$V_{SD}$	-	-	1	V

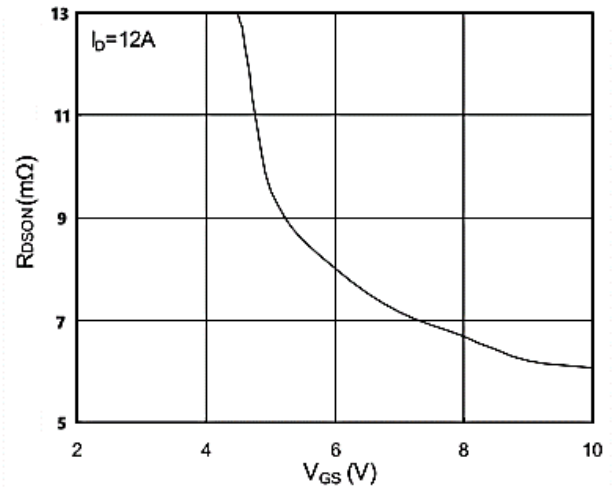
Note :

- 1、 The data tested by surface mounted on a 1 inch2 FR-4 board with 2OZ copper.
- 2、 The data tested by pulsed , pulse width  $\leq 300\mu s$  , duty cycle  $\leq 2\%$
- 3、 The EAS data shows Max. rating . The test condition is  $V_{DD}=25V, V_{GS}=10V, L=0.1mH, I_{AS}=34A$
- 4、 The power dissipation is limited by 150°C junction temperature
- 5、 The data is theoretically the same as ID and IDM , in real applications , should be limited by total power dissipation.

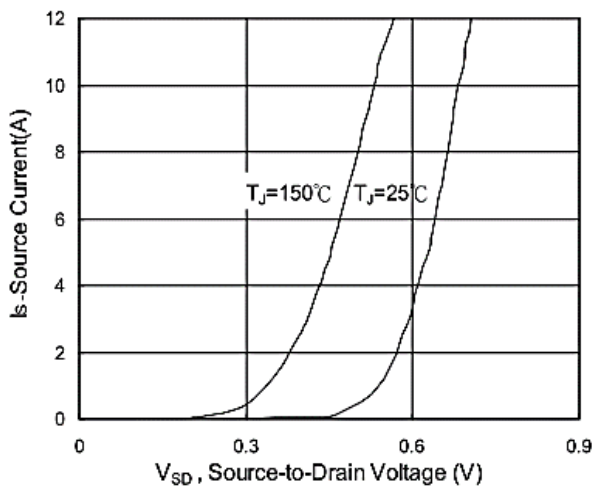
**Typical Characteristics**



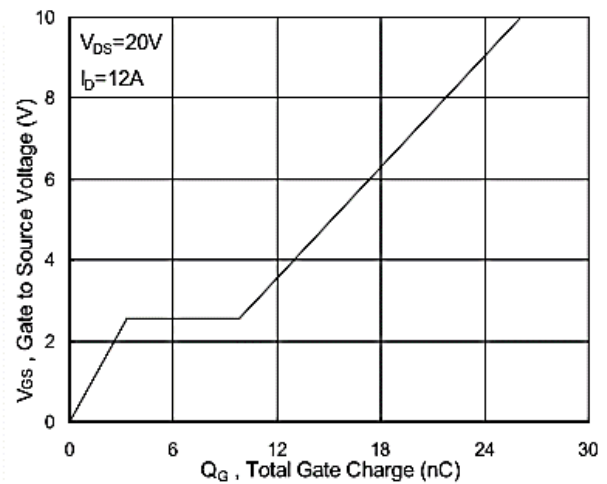
**Fig.1 Typical Output Characteristics**



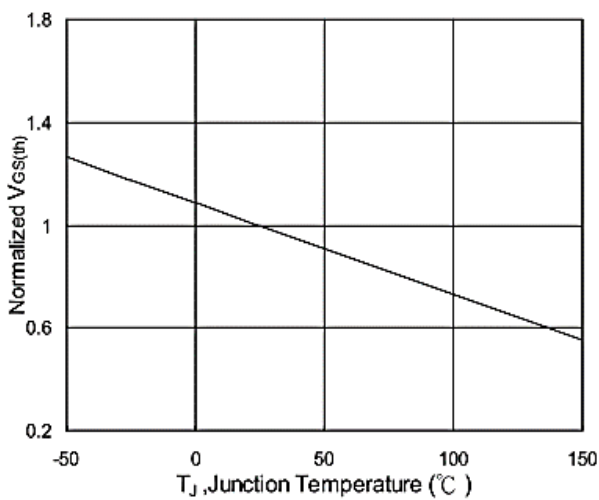
**Fig.2 On-Resistance vs. G-S Voltage**



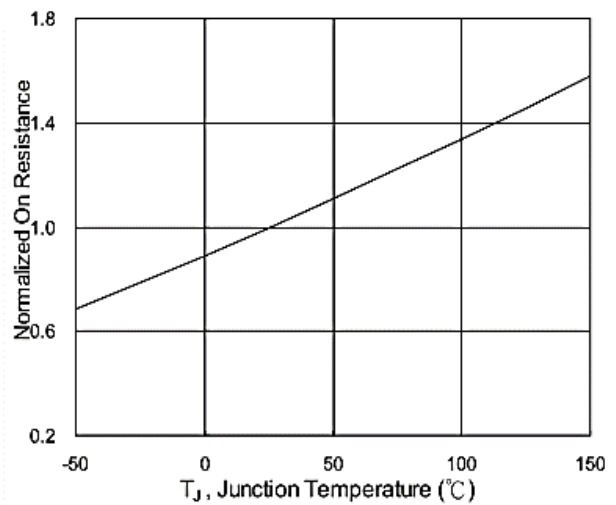
**Fig.3 Forward Characteristics of Reverse**



**Fig.4 Gate-Charge Characteristics**

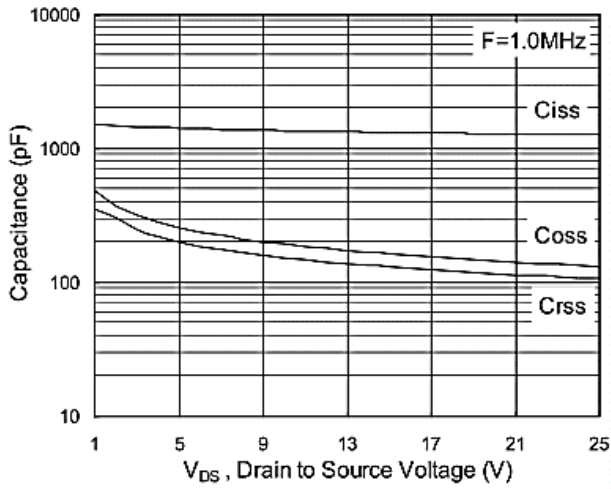


**Fig.5 Normalized  $V_{GS(th)}$  vs.  $T_J$**

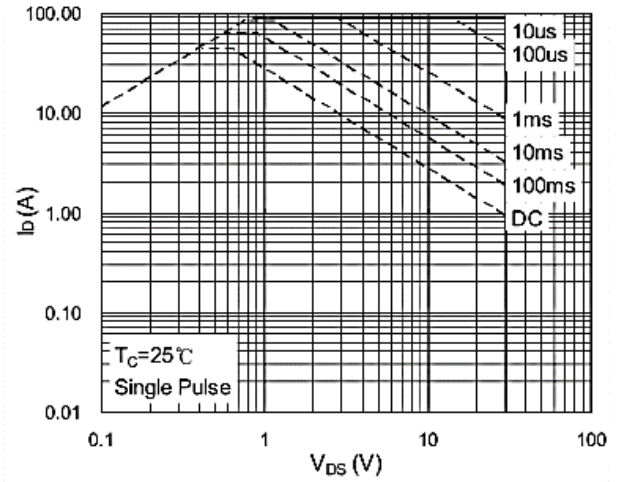


**Fig.6 Normalized  $R_{DS(on)}$  vs.  $T_J$**

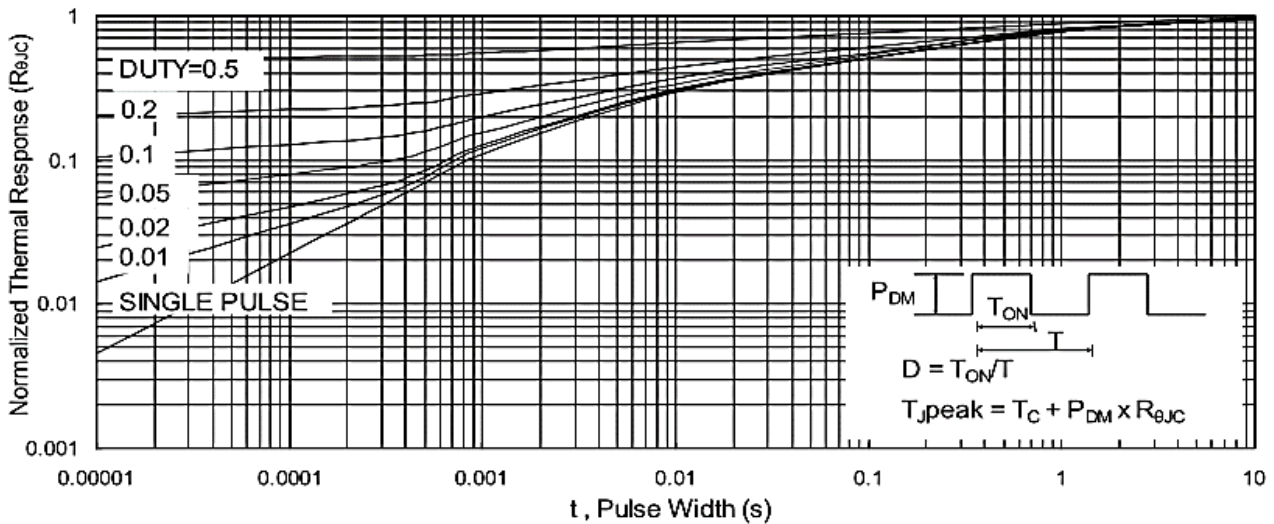
**Ratings and Characteristic Curves**



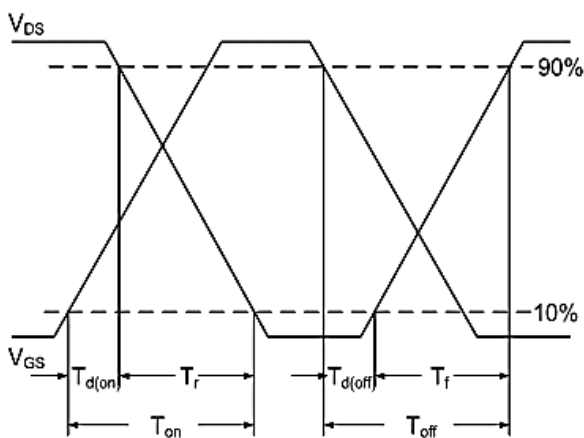
**Fig.7 Capacitance**



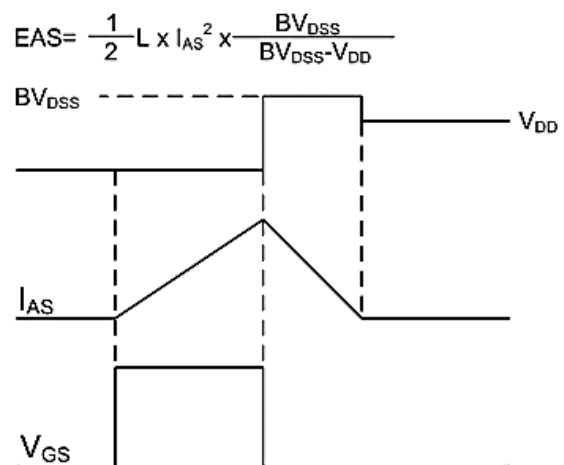
**Fig.8 Safe Operating Area**



**Fig.9 Normalized Maximum Transient Thermal Impedance**



**Fig.10 Switching Time Waveform**



**Fig.11 Unclamped Inductive Switching Waveform**

Package Outline Dimensions Millimeters

TO-252

Dim.	Min.	Typ.	Max.
A	2.10	-	2.50
A2	0	-	0.10
B	0.66	-	0.86
B2	5.18	-	5.48
C	0.40	-	0.60
C2	0.44	-	0.58
D	5.90	-	6.30
D1	5.30REF		
E	6.40	-	6.80
E1	4.63	-	-
G	4.47	-	4.67
H	9.50	-	10.70
L	1.09	-	1.21
L2	1.35	-	1.65
V1	-	7°	-
V2	0°	-	6°
All Dimensions in millimeter			

