

Intel® Joule™ Module

Datasheet

September 2016

Revision 1.1

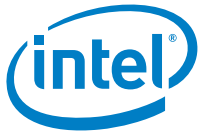

No license (express or implied, by estoppel or otherwise) to any intellectual property rights is granted by this document.

This document contains information on products, services, and/or processes in development. All information provided here is subject to change without notice. Contact your Intel representative to obtain the latest forecast, schedule, specifications, and roadmaps.

The products and services described may contain defects or errors known as errata, which may cause deviations from published specifications. Current characterized errata are available on request.

You may not use or facilitate the use of this document in connection with any infringement or other legal analysis concerning Intel products described herein. You agree to grant Intel a nonexclusive, royalty-free license to any patent claim thereafter drafted that includes subject matter disclosed herein.

Intel does not control or audit third-party benchmark data or the web sites referenced in this document. You should visit the referenced web site and confirm whether referenced data are accurate.

Intel technologies may require enabled hardware, specific software, or services activation. Check with your system manufacturer or retailer.

Copies of documents that have an order number and are referenced in this document may be obtained by calling 1-800-548-4725 or by visiting www.intel.com/design/literature.htm.

The Intel Joule Module, Intel and the Intel logo are trademarks of Intel Corporation in the United States and other countries.

*Other names and brands may be claimed as the property of others.

Copyright © 2016 Intel Corporation. All rights reserved

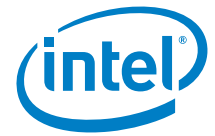

Revision History

Revision	Description	Date
1.1	Update wireless communication statement for end-use equipment integration	September 2018
1.0	Initial release	August 2016



Contents

1	Introduction	8
1.1	Acronyms	8
1.2	Reference documents	9
2	System on a Module Overview	9
2.1	Intel® Joule™ configurations	9
2.2	Intel® Joule™ feature summary	10
2.3	Expansion board requirements	10
2.3.1	Method for connecting module to expansion board	10
2.3.2	Method to provide +VSYS power to the module	10
2.3.3	Required strapping of module pins	11
2.3.4	BIOS installed onto module	11
2.4	Expansion board recommendations	11
2.4.1	External EEPROM for multipurpose pin configuration data	11
2.4.2	Power button	11
2.4.3	DnX button	11
2.4.4	Real time clock (RTC) backup power source	11
2.4.5	UART debugging	11
3	Power Delivery, Signaling, and Reset	12
3.1	Main power supply (VSYS)	12
3.2	Power on signaling	12
3.2.1	+VDC_IN power sensing	12
3.2.2	+VBUS power sensing	12
3.2.3	Power good	12
3.3	Hard shutdown via power button	12
3.4	System voltage rail specifications	13
4	Graphics Specifications	13
4.1	Intel® Gen9LP features	13
4.2	Graphic encoder and decoder support	14
4.3	HDMI* signal group specifications	14
5	Wireless Connectivity	15
5.1	Intel® Dual Band Wireless-AC 8260 highlights	15
5.1.1	Wi-Fi features	15
5.2	Bluetooth® highlights	15
5.2.1	Supported Bluetooth® profiles	15
5.3	Security	16
5.4	Wireless antenna connectors	16
5.5	The Intel® Dual Band Wireless-AC 8260 support site	16
6	SD Card Interface	17
6.1	SD card interface features	17
6.1.1	SD card signal group specifications	17
7	Module Connectors	17
7.1	Module dimensions	17
7.2	Module to expansion board connectors	18
7.2.1	Module electrostatic discharge	18
7.2.2	J6 connector interface signals	18
7.2.3	J7 connector interface signals	20
8	I2C Interfaces	22
8.1	I2C features	22
8.2	I2C default configuration	22
8.3	I2C signal group specifications	22

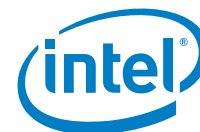

9	Clock Specifications	22
9.1	RTC backup battery	22
10	UART Specifications	23
10.1	UART availability	23
11	I2S Specifications	23
11.1	I2S signal group specifications	23
11.1.1	I2S available formats	23
11.2	Digital microphone ports	24
12	GPIO Specifications	24
12.1	Dedicated GPIO lines	24
12.2	Reconfigurable interfaces buses as GPIO	24
12.3	GPIO internal pull UP / pull DOWN resistors	24
12.4	Linux* GPIO to function mapping	25
13	Pulse Width Modulators	26
13.1	PWM frequency formula:	26
13.2	PWM duty cycle formula:	26
14	Universal Serial Bus	26
14.1	Available USB ports	26



Tables

1	Acronyms and terminology	8
2	Intel® Joule™ configurations	9
3	Intel® Joule™ features	10
4	Required strapping of module pins	11
5	Boot decision per voltage supply condition	12
6	Module power rails.....	13
7	Graphics engine encoders and decoders supported.....	14
8	J6 connector pin descriptions	18
9	J7 connector pin descriptions	20
10	I2C mapping.....	22
11	Available UARTS.....	23
12	I2S available configuration formats	23
13	Linux* GPIO number to module signal.....	25
14	PWM programming examples	26
15	USB port types.....	26

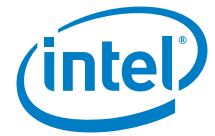

Figures

1	Wireless antenna connector location	16
2	Module physical connectors	17

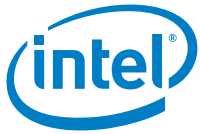

1 Introduction

This datasheet outlines the technical features of the Intel® Joule™ system-on-module (SoM) that combines high-performance compute and graphics with large memory and wireless connectivity in a tiny footprint.

1.1 Acronyms

Table 1 Acronyms and terminology

Acronyms	Description
DVS	Dynamic Voltage Scaling
eMMC*	embedded Multimedia Card, a lower cost type of boot ROM
GPIO	General Purpose Input/Output
HDMI*	High-Definition Multimedia Interface
I2C	IIC - Inter-Integrated Circuit
I2S	Inter-IC Sound
IA	Intel Architecture
ISH	Integrated Sensor Hub
LPDDR	Low Power Double Data Rate
LPSS	Low Power Subsystem
OSC	Oscillator
PCB	Printed Circuit Board
PMIC	Power Management Integrated Circuit
RTC	Real Time Clock
SCU	System Controller Unit
SDIO	Secure Digital Input/Output
SOC	System on Chip; combines compute, graphics and interface in a single device
SOM	System on Module; contains the SOC and additional components in a single package
SPI	Serial Peripheral Interface (Bus)
TAP	Test Access Port
TBD	To Be Defined - information not available in this release
UART / HSUART	UART - as used in this document, UART ports are to be assumed as only supporting Rxd, TxD signals HSUART - is a full function UART with Clear to Send and Return to Send handshakes for High Speed transfers
ULPI	UTMI+ Low Pin Interface
XTAL	Crystal



1.2 Reference documents

Intel Documents	Intel Document Number or Internet Address
Intel® Joule™ Platform Mechanical Descriptor	568978
Intel® Joule™ Expansion Board Datasheet	569056 - pending release at time of this publication
Intel® Joule™ Expansion Board Design Guide	566861 - pending release at time of this publication
Intel® Joule™ Thermal Management Guide	568457 - pending release at time of this publication
Intel® Joule™ Product Website	https://software.intel.com/en-us/iot/hardware/joule
Intel® Joule™ Online User Guide	https://software.intel.com/en-us/intel-joule-getting-started
Intel® Joule™ Online Community	https://communities.intel.com/community/tech/intel-joule
Intel® Joule™ FCC and FAA Regulatory Information	http://www.intel.com/content/www/us/en/support/boards-and-kits/000022313.html
Industry Specifications	Internet Address
JEDEC Standard LPDDR4 Specification	http://www.jedec.org
Universal Serial Bus Specification (USB)	http://www.usb.org/developers/doc
USB* On-The-Go (OTG) and Embedded Host	http://www.usb.org/developers/onthego
HDMI* Specification v1.4b	http://www.hdmi.org/manufacturer/specification.aspx

Note: Intel does not control or audit third-party benchmark data or the web sites referenced in this document. You should visit the referenced web site and confirm whether referenced data are accurate.

2 System on a Module Overview

The Intel® Joule™ system-on-module (SoM) is available in multiple configurations that share the same footprint and interface connector placement. This enables accelerated product designed by providing multiple levels of compute power, graphics, memory and communication options in a single common footprint that can scale with end-product requirements.

2.1 Intel® Joule™ configurations

Table 2 Intel® Joule™ configurations

Module	CPU Clock	Graphic Clock	Memory and Storage
Intel® Joule™ 550x	1.5 GHz	300 MHz	3GB RAM & 8GB eMMC Flash
Intel® Joule™ 570x	1.7 GHz; Turbo Boost up to 2.4GHz	450 MHz base, 650 MHz Turbo	4GB RAM & 16GB eMMC Flash

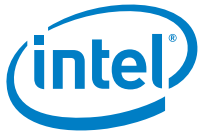

2.2 Intel® Joule™ feature summary

Table 3 Intel® Joule™ features

Domain	Attribute	Value	Notes
Compute	System on a Chip	14nm Intel® Atom™ quad-core	4 cores supporting 2 threads per core
	Address Bus Size	64-Bit (x86-64)	
	Cache	4MB L1	2MB per core-pair
RAM	Type and Speed	LPDDR4 (4 lanes, 3200 MT/sec)	Integrated Package on Package
Graphics	Execution Units	12EUs (2x6) on 550x and 18EUs (3x6) on 570x	
	Open Graphics Libraries	Open GL 3.1ES, Open GL4.3 & Open CL 2.0	
Display	HDMI Output	HDMI 1.4b	1080p at 60fps via expansion board connectors
Storage	Type Supported	eMMC 5.0	Max eMMC speed of 400 MB/second
Expansion Connector	Module to expansion board	Two, 2x50 pin connectors	Hirose Electric Co LTD* Part Number DF40C-100DP-0.4V
Audio	Number of DMIC	2	Routed via expansion board connectors
	Number and Speed of I ² S	One I ² S at 9.6 MHz	
USB	USB 3.0 compliant	1 Type C OTG and 1 Host	USB 3, Port 0 is dedicated to Type C USB 3, Port 1 is multiplexed with PCIe
PCIe*	Number of Ports / lanes	1 port / 1 lane	Multiplexed with USB3, Port1
	Max Speed	5 Gb/s	
SIO	I ² C	5 ports (3 LPSS, 2 ISH as LPSS)	Master Mode; max 3.4Mb/s
	UARTS	3 full and 1 half	Maximum rate of 115.2 kb/s for half speed and 3.6864 Mb/s maximum for full speed mode(s)
	SPI	2 ports, 5 chip selects	Up to 25MHz
SDIO	Number of ports	1	For SD Card interface
GPIO	Dedicated GPIO lines	8	Up to 48 when remapping interface pins
	Additional GPIO lines	Up to 48	Interfaces pins can be remapped within BIOS (tool release pending)
	PWM	4	
Wi-Fi and Bluetooth®	Integrated wireless module	Intel® Dual Band Wireless-AC 8260	
	Bands	Dual Band MIMO 2x2	2.4 and 5GHz
	Standards	IEEE 802.11agn + ac, BT 4.2 core	
	Security	WPA, WPA2, WPS2, 802.11w, WMM, WMM-PS, WFD, Miracast, Passpoint	
	Dual mode, BT 4.1 Core	Over 15 profiles supported	WPA2, AES-CCMP encryption
Antenna	Dual MHF4 connectors on module	Connection A1 is Wi-Fi only while connection A2 services both BT and Wi-Fi	
Power Manager	Integrated PMIC	Whiskey Cove	Not user programmable

2.3 Expansion board requirements

The Intel® Joule™ Expansion Board Design Guide (See [Section 1.2](#)) provides design recommendations for designing customer expansion boards. At a minimum, the following elements are required to enable successful module boot and operation.

2.3.1 Method for connecting module to expansion board

The module must be securely mounted to an expansion board in a method that maintains full engagement of the board-to-board interface connectors. See the Intel® Joule™ Platform Mechanical Descriptor for more information.

2.3.2 Method to provide +VSYS power to the module

The subject is covered in [Section 3](#)

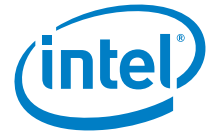

2.3.3 Required strapping of module pins

These module pin strappings must be implemented for boot during rising edge of PMIC_PWRGOOD (J6, pin 33).

Table 4 Required strapping of module pins

Signal Name	Location	Default	Requirement
GPIO_UART_TXD	J6, pin 93	Internal 20k pull down	Must be Hi-z or pulled down to GND when PMIC_PWRGOOD asserts
ISH_UART0_RTS	J7, pin 11	Internal 20k pull up	Must be Hi-z or pulled up to VDD1 when PMIC_PWRGOOD asserts
ISH_UART0_TXD	J7, pin 15	Internal 20k pull down	Must be Hi-z or pulled down to GND when PMIC_PWRGOOD asserts
SSPO_SPI_FS1	J7, pin 79	Internal 20k pull up	Must be Hi-z or pulled up to VDD1 when PMIC_PWRGOOD asserts

2.3.4 BIOS installed onto module

The module requires a Basic Input Output System (BIOS) code to be installed in the device firmware in order to complete the boot and initialization process. The reference configuration loaded during module production can be overwritten with either an updated, approved reference BIOS or a custom BIOS developed by other users, customers or partners.

Caution: Turning off the device during a BIOS update can cause data corruption and loss of functionality.

Warning: End-use equipment integrating the device has to be authorized as required by the U.S. Federal Communications Commission ("FCC") or it has to be operated in accordance with the FCC's rules on operation of unauthorized devices (47 C.F.R. § 2.805), including obtaining approval from any licensed spectrum operator, if the end-use equipment will use such operator's spectrum

Hyperlink: [Regulatory Information for the Intel® Joule™ Compute Module](#)

2.4 Expansion board recommendations

2.4.1 External EEPROM for multipurpose pin configuration data

An external EEPROM (recommend ST Microelectronics M24M02-DR* or equivalent) connected to I2C port 0 will hold a specific configuration of the multipurpose pins. During boot, if the BIOS does not find an EEPROM device attached to I2C port 0, then the module will load the default configuration that is stored in BIOS.

2.4.2 Power button

Connect an active low power button to J6 pin 9 to trigger a reset or to power cycle the board.

2.4.3 DnX button

Connect an active high (VDD1) signal to J6, pin 78 to initiate a Download and Execute routine that will update the BIOS via USB 2.0, port 0. This DnX button signal is the only way to initiate the Download and Execute update process.

2.4.4 Real time clock (RTC) backup power source

See section [Section 9.1](#)

2.4.5 UART debugging

Include a method to access UART port 2 on the module during boot to collect debug information as this is the only way to access debug messages generated during the power on and boot sequences.



3 Power Delivery, Signaling, and Reset

3.1 Main power supply (VSYS)

The Intel® Joule™ module requires VSYS source routed through 12 pins, 6 on each board-to-board connector, that must all be connected in common to balance the current path.

This is the only power input path; voltage detection at +VDC_IN or USB VBUS will trigger module boot.

Caution: It is NOT possible to supply VSYS directly from any USB power supply, as the USB operating specification of 4.75V to 5.25V may exceed the safe operational range of the module.

Table 5 Boot decision per voltage supply condition

+VDC_IN	+VBUS	VSYS	Action
0 VDC	0 VDC	>VSYS (min)	No Boot
0 VDC	>+VBUS (min)	>VSYS (min)	Cold Boot
>+VDC_IN (min)	0 VDC	>VSYS (min)	Cold Boot
>+VDC_IN (min)	>+VBUS (min)	>VSYS (min)	Cold Boot

3.2 Power on signaling

3.2.1 +VDC_IN power sensing

+VDC_IN is the signal that indicates when the module is being powered from an external power source.

When no RTC battery is present, the system will boot when both +VDC_IN and VSYS are at a valid level.

If an RTC battery is present, the operating system can configure the wake source register of the PMIC to either boot when +VDC_IN is present, or to wait for a signal on the power button line.

3.2.2 +VBUS power sensing

The +VBUS pin is used by the module to detect if power is present on the USB connector of the attached expansion board. If the +VBUS pin is within the voltage range specified in Table 5, then the module will initiate a boot.

3.2.3 Power good

The module will assert the PMIC_PWRGOOD signal HIGH after the VDD1 and VDD3 rails are within specification.

3.3 Hard shutdown via power button

The Intel® Joule™ module has a single Power Button pin (PMIC_PWRBTN_N) that will trigger a shutdown of the module when held LOW for longer than 10 seconds.



3.4 System voltage rail specifications

The outputs shown below are only intended to signal or enable other subsystems and not to drive loads.

Table 6 Module power rails

Rail Name	Voltage				Current			Direction	Usage
	Min	Typ	Max	Units	Min	Max	Units		
+VSYS	3.6	4	5	V		4	A	Input	Powers the core logic and radios. Recommend using 5V if using the CSI cameras.
+VDD3	3.1	3.3	3.45	V		300	mA	Output	General use. Powers on prior to VDD1
+VBUS	4	5	20	V		20	uA	Input	Voltage sense for VBUS power
+V5P0V_VCONN	4.75	5	5.25	V		300	mA	Input	Voltage for USB-C VCONN to CC1 or CC2
+VDD1	1.71	1.8	1.89	V		300	mA	Output	General use. Power on after +VDD3
+VDC_IN	4	12	20	V	20	20	uA	Input	Voltage sense for +VDC_IN power
+VRTC	2.05		3.3	V	20	500	uA	Input	RTC backup voltage - supplies voltage to RTC logic when the system is not-powered.
+VBATTERY	0	3.8	5	V	<20		uA	Input	Voltage detection for battery. May be used to configure battery voltage as a gate to boot.

4 Graphics Specifications

4.1 Intel® Gen9LP features

- Gen9LP graphic engine can run at 450MHz or 650MHz according to model. See Table 2
- Intel 9th generation (Gen 9LP) graphics encoder / decoder engine
- Three slices of 6 EUs; each slice supports 6 threads resulting in a total of 12 or 18 available threads, depending on device SKU and configuration. See Table 2
- Supports 3D rendering, media composting, and video encoding
- Graphics burst enabled through energy counters
- Supports OpenGL* 4.3, OpenGL ES 3.1 and OpenCL 2.0
- 4x anti-aliasing
- Supports content protection using PAVP and HDCP 1.4/2.0
- Hardware capable of (up to) 4k video encode and decode; software dependencies exist.

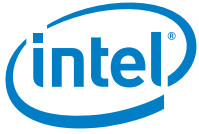

4.2 Graphic encoder and decoder support

Table 7 Graphics engine encoders and decoders supported

Format	Decode Level	Encode Level
H.264	Profiles: CBP, MP, HP Level: L5.2 up to 1080p240, 4kx2kp60 (2x) Bit-rate up to 250 Mbps	Profiles: CBP, MP, HP Level: L5.2 up to 1080p240, 4kx2kp60 Bit-rate: up to 250 Mbps
MVC	CBP, MP HPL5.2 up to 4kx2kp60	CBP, MP HPL5.1 up to 4kx2kp30
VP8	Up to 4kx2kp60	1080p60
VP9	Up to 4kx2kp60	Up to 720p60, 1080p30
MPEG2	HD MPHL (1080p60)	HD MPHL (1080p30)
VC-1	AP L4 (1080p60)	
WMV9	MP HL (1080p30)	
JPEG/MPEG	1067 Mpps (420), 800 Mpps (422) at 400MHz, 25% non-zero coefficients)	1067 Mpps (420), 800 Mpps (422) (at 400MHz, 25% non-zero coefficients)

Note: Specific formats and configurations may require software support for the chosen operating system.

4.3 HDMI* signal group specifications

The Intel Joule module provides a HDMI 1.4b interface through the board-to-board connectors for expansion board usage. Refer to the Intel® Joule™ Expansion Board Design Guide for the specifications and PCB routing guidance for this interface.



5 Wireless Connectivity

The Intel® Joule™ module contains an integrated Intel® Dual Band Wireless-AC 8260 adapter.

5.1 Intel® Dual Band Wireless-AC 8260 highlights

5.1.1 Wi-Fi features

- Dual-band 2.4 GHz and 5 GHz with MIMO 2x2
- Antenna Diversity is supported
- Radio on/off control via software
- Supports seamless roaming between access points; within respective band and mode of access point
- Compatible with Wi-Fi Alliance protocols - note, module is NOT Wi-Fi Alliance certified
 - Wi-Fi CERTIFIED™ a/b/g/n/ac
 - WMM*, WMM-PS, WPA*, WPA2*, and WPS2*
 - Protected Management Frames
 - Wi-Fi Direct® for peer to peer device connections
 - Wi-Fi CERTIFIED™ Miracast Source
- IEEE WLAN Standards:
 - IEEE 802.11abgn, 802.11a/b/g/n/ac, 802.11d, 802.11e, 802.11h, 802.11i, 802.11w, 802.11r, 802.11k

5.2 Bluetooth® highlights

Dual mode Bluetooth® 4.2 Smart (Low Energy) enabling BR/EDR protocols

- Supports Bluetooth® Core Specification Version 4.2 with provisions for supporting future specifications
- Bluetooth® Class 1 or Class 2 transmitter operation

5.2.1 Supported Bluetooth® profiles

- Advanced Audio Distribution Profile (A2DP) (Source/Sink)¹
- Audio/Video Remote Control Profile (AVRCP) (Controller/Target)¹
- Basic Imaging Profile (BIP) (Initiator/Responder)
- Basic Printing Profile (BPP) (Sender)
- File Transfer Profile (FTP) (Client/Server)
- Generic Access Profile (GAP)
- Generic Attribute Profile (GATT)
- Generic Audio/Video Distribution Profile (GAVDP) (Source/Sink)¹
- Generic Object Exchange Profile (GOEP) (Client/Server)
- Hands-Free Profile (HFP) (Audio Gateway) with Wide-Band Speech support (WBS)¹
- Hardcopy Cable Replacement Profile (HCRP) (Client)
- Headset Profile (HSP) (Audio Gateway)¹
- HID over GATT profile (HOGP) (Host), also known as Low Energy HID profile²
- Object Push Profile (OPP) (Client/Server)
- Phone Book Access Profile (PBAP) (Client)
- Synchronization Profile (SYNC) (Client)

5.3 Security

- Authentication: WPA and WPA2, 802.1X (EAP-TLS, TTLS, PEAP, LEAP, EAP-FAST), EAP-SIM, EAP-AKA
- Authentication Protocols: PAP, CHAP, TLS, GTC, MS-CHAP*, MS-CHAPv2
- Encryption: 64-bit and 128-bit WEP, AES-CCMP
- Wi-Fi Direct® Encryption and Authentication: WPA2, AES-CCMP

5.4 Wireless antenna connectors

The module contains two MHF4 (U.FL compatible) antenna connectors that are labeled 1 and 2 with a triangle-shaped mark.

- A1 is dedicated to the Wi-Fi service
- A2 supports both Wi-Fi and Bluetooth services

Figure 1 Wireless antenna connector location

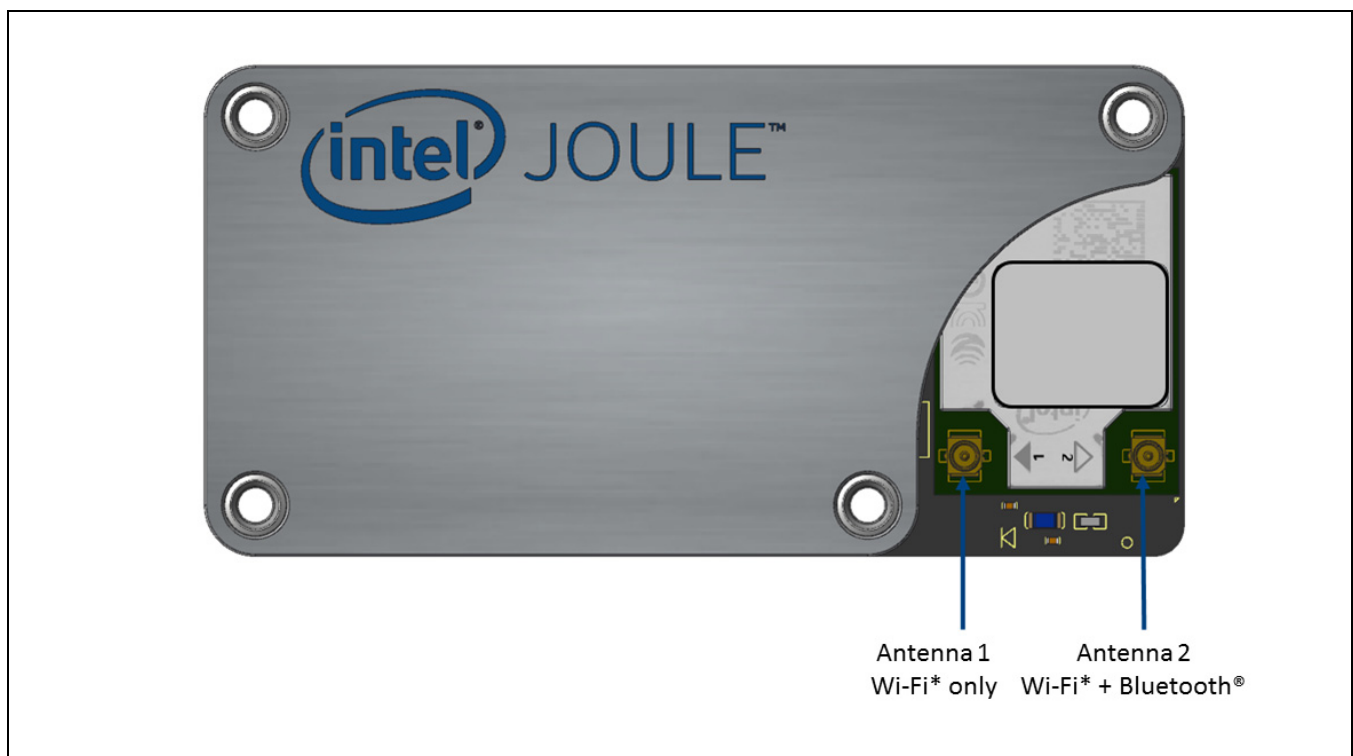

5.5 The Intel® Dual Band Wireless-AC 8260 support site

Hyperlink: <http://www.intel.com/content/www/us/en/support/network-and-i-o/wireless-networking/intel-wi-fi-products/intel-dual-band-wireless-ac-8000-series/intel-dual-band-wireless-ac-8260.html>

Warning: End-use equipment integrating the device has to be authorized as required by the U.S. Federal Communications Commission ("FCC") or it has to be operated in accordance with the FCC's rules on operation of unauthorized devices (47 C.F.R. § 2.805), including obtaining approval from any licensed spectrum operator, if the end-use equipment will use such operator's spectrum

Hyperlink: Regulatory Information for the Intel® Joule™ Compute Module

6 SD Card Interface

6.1 SD card interface features

- Host clock up to 208 MHz (SDR 104)
- Supports card detection (insertion/removal) with dedicated card detection signal
- Meets SD Host Controller Standard Specification version 3.0
- Meets SD Physical Layer Specification version 3.01
- Only supports SD memory
- Supports 1.8v signal levels directly; requires an external level shifter to support devices that operate above 1.8V

6.1.1 SD card signal group specifications

The Intel Joule module provides a SD Card interface through the board-to-board connectors for expansion board usage. Refer to the Intel® Joule™ Expansion Board Design Guide for the specifications and PCB routing guidance for this interface.

7 Module Connectors

The Intel® Joule™ module utilizes two separate, connectors, (J6 & J7) to break out system buses, power and GPIO signals.

- All I/O signals are 1.8V with the exception of USB and PCIe which adhere to their respective standards.
- Module connectors J6 and J7 (2x50) are common with Hirose Electric Co LTD* Part Number DF40C-100DP-0.4V and mate with Hirose Electric Co LTD* Part Number DF40C-100DS-0.4V, or compatible.
- JCAM1 and JCAM2 are reserved for future development of MIPI based imaging interfaces.

Figure 2 Module physical connectors

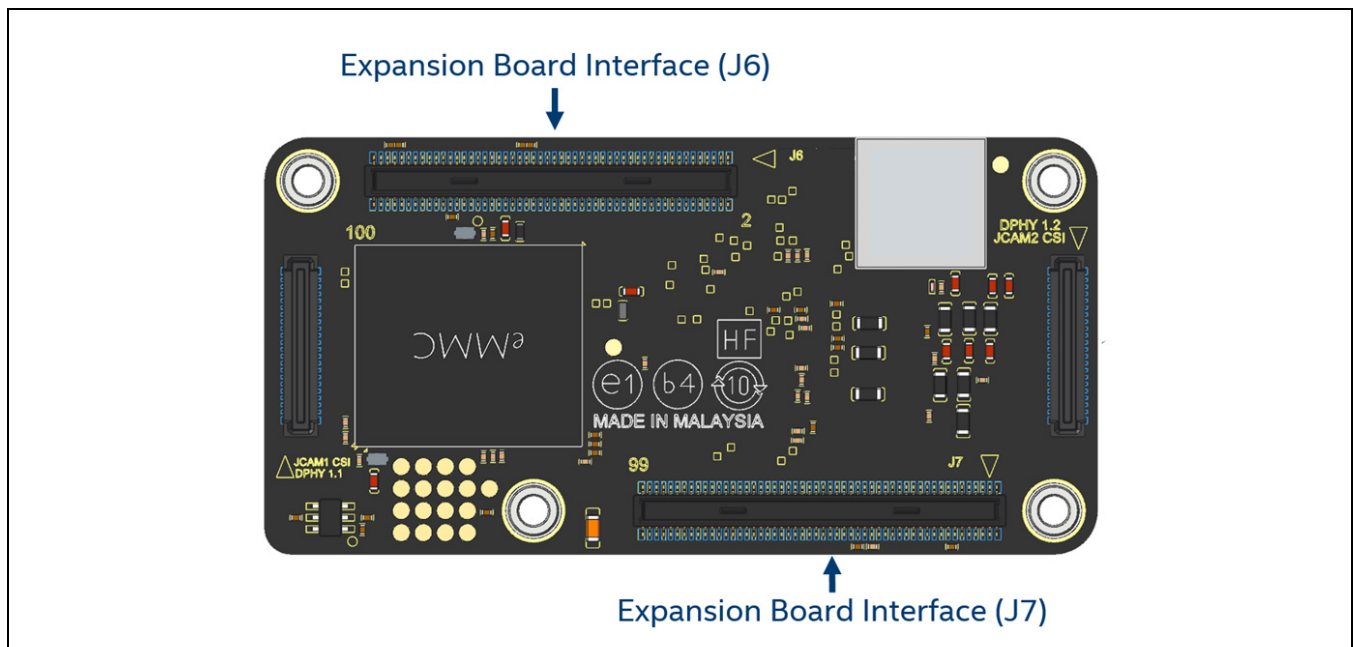

7.1 Module dimensions

See the Intel® Joule™ Platform Mechanical Descriptor for complete module and connector dimensions.

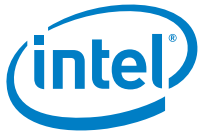

7.2 Module to expansion board connectors

7.2.1 Module electrostatic discharge

ESD testing is performed at the system level, where the module is connected to an expansion board, and not at the module connectors. See the Intel® Joule™ Expansion Board Design Guide for more ESD information.

7.2.2 J6 connector interface signals

Table 8 J6 connector pin descriptions

Pin	Signal Name	Usage	Description
36	+VDD1	Output	System 1.8 V
30	+VDD3	Output	System 3.3 V
41	+V5P0V_VCONN	Input	Power for USB3.0 CC pins for VCONN-powered accessory.
40	CHRG_INT_N	Input	General purpose input/output for the expansion board charger's interrupt pin, active low. Allows charger to interrupt host to report charger device status and faults. Connected to GPIO_19.
35	CHRG_EN_N	Output	General purpose input/output for the expansion board charger's enable pin, active low. Allows battery to be charged when power is connected to VDC_IN. Connected to GPIO_15.
43	CODEC_MCLK	Output	MCLK for Master Mode operation for I ² S audio
16	ISH_I2C_0_SCL	Output	Integrated sensor hub port 0 I ² C clock (open collector)
18	ISH_I2C_0_SDA	Input/Output	Integrated sensor hub port 0 I ² C data (open collector)
21	ISH_I2C_1_SCL	Output	Integrated sensor hub port 1 I ² C clock (open collector)
23	ISH_I2C_1_SDA	Input/Output	Integrated sensor hub port 1 I ² C data (open collector)
46	HDMI_CLK_DN	Output	HDMI clock negative
44	HDMI_CLK_DP	Output	HDMI clock positive
68	DDI1_CTRL_CLK	Output	HDMI I2C clock
70	DDI1_CTRL_DAT	Input/Output	HDMI I2C data
62	HDMI_TX_0_DN	Output	HDMI data lane 0 negative
58	HDMI_TX_1_DN	Output	HDMI data lane 1 negative
50	HDMI_TX_2_DN	Output	HDMI data lane 2 negative
64	HDMI_TX_0_DP	Output	HDMI data lane 0 positive
56	HDMI_TX_1_DP	Output	HDMI data lane 1 positive
52	HDMI_TX_2_DP	Output	HDMI data lane 2 positive
74	UART2_CTS	Input	UART port 2 clear to send. UART port 2 is used as a debug port for BIOS messages during boot.
76	UART2_RTS	Output	UART port 2 ready to send. UART port 2 is used as a debug port for BIOS messages during boot.
80	UART2_RXD	Input	UART port 2 receive data. UART port 2 is used as a debug port for BIOS messages during boot.
78	UART2_TXD	Output	UART port 2 transmit data. UART port 2 is used as a debug port for BIOS messages during boot. Pin includes hardware strapping functionality for DNX boot.
4,10,19,4 2,48,54,6 0,66,72,7 3,82,86,9 6,98,100	GND	Ground	System ground
39	I2S_1_CLK	Input/Output	I ² S bit clock. Supplied by the module in master mode and serves as an input in slave mode.
45	I2S_1_FS	Output	I ² S frame sync
47	I2S_1_RXD	Input	I ² S receive data
49	I2S_1_TXD	Output	I ² S transmit data
94	GPIO_22	Input/Output	General purpose input/output
1	PWM_0	Output	Programmable pulse width modulator port 0
3	PWM_1	Output	Programmable pulse width modulator port 1



Table 8 J6 connector pin descriptions

Pin	Signal Name	Usage	Description
22	PWM_2	Output	Programmable pulse width modulator port 2
24	PWM_3	Output	Programmable pulse width modulator port 3
65	HPD_SRC	Input	General purpose input/output for HDMI cable hot plug detect. Instantiates a start-up communication between source and sink HDMI devices. Connected to GPIO_200.
84	BTN_N	Input	Connected to general purpose button on the expansion board. Connected to GPIO_17.
57	I2C_0_SCL	Output	I ² C port 0 clock
95	I2C_0_SDA	Input/Output	I ² C port 0 data
25	ISH_GPIO_0	Input/Output	ISH general purpose input/output 0
27	ISH_GPIO_1	Input/Output	ISH general purpose input/output 1
32	ISH_GPIO_2	Input/Output	ISH general purpose input/output 2
34	ISH_GPIO_3	Input/Output	ISH general purpose input/output 3
29	ISH_GPIO_4	Input/Output	ISH general purpose input/output 4
38	ISH_GPIO_5	Input/Output	ISH general purpose input/output 5
31	ISH_GPIO_6	Input/Output	ISH general purpose input/output 6
71	CLK_19P2M	Output	19.2 MHz clock
69	OTG_EN	Output	General purpose input/output controlled by PMIC to enable the module to power a USB OTG device
9	PMIC_PWRBTN_N	Input	System power/sleep button input to PMIC; active low.
33	PMIC_PWRGOOD	Output	Notification to system that all cold boot voltage rails to power the system have ramped up. Transitions high when module rails are within specification.
13	PMIC_RESET_N	Input	Notification to system that PMIC will respond to commands. When asserted, the PMIC will not respond to SOC commands via I2C or SVID because of the PMIC being either in standby or because a TLP is running. This is an active low signal.
79	SDCARD_CD_N	Input	SD card detect. Active low when a card is present, pulled high with internal pull-up when card is not present.
75	SDCARD_CLK	Output	SD card clock
89	SDCARD_CMD	Input/Output	SD card command is used for card initialization and transfer of commands.
81	SDCARD_D0	Input/Output	SD card data 0. By default, during power up or reset, only data 0 is used for data transfer.
83	SDCARD_D1	Input/Output	SD card data 1
85	SDCARD_D2	Input/Output	SD card data 2
87	SDCARD_D3	Input/Output	SD card data 3
77	SDCARD_LVL_CLK_FB	Input	SD card clock feedback for aligning the SDIO data from the level shifter on-board the expansion board via the controller. There is a loopback through the SD card level shifter that drives this pin.
90	SDCARD_LVL_CMD_DIR	Output	SD card command direction indicates whether host is transmitting or receiving over the command pin.
67	SDCARD_LVL_DAT_DIR	Output	SD card data direction indicates whether host is transmitting or receiving over the data.
88	SDCARD_LVL_SEL	Output	SD card level select performs the 1.8V to 3.0V negotiation.
91	SDCARD_PWR_DOWN_N	Output	SD card power down indicates to SDIO device to power down.
53	SPI_1_CLK	Output	SPI port 1 clock
63	SPI_1_MISO	Input	SPI port 1 receive data
55	SPI_1_FS0	Output	SPI port 1 slave select 0
14	SPI_1_FS2	Output	SPI port 1 slave select 2. Hardware strap with disable boot from SD card functionality.
51	SPI_1_MOSI	Output	SPI port 1 transmit data
93	UART_0_TXD	Output	UART port 0 transmit data. Hardware strap with reserved functionality. Note: Goes with UART0 signals on other connector
26	UART_1_RXD	Input	UART port 1 receive data
28	UART_1_TXD	Output	UART port 1 transmit data. Hardware strap with disable boot from eMMC functionality.
20	USB2_ID_PMIC	Input	USB OTG ID for device attach/detach and USB ACA detection via detection of resistance connected to pin. Connected to PMIC USBID pin.
8	USB2_0_DN	Input/Output	USB 2.0 port 0 data negative. Connected to PMIC USB 2.0 port 0.
6	USB2_0_DP	Input/Output	USB 2.0 port 0 data positive. Connected to PMIC USB 2.0 port 0.



Table 8 J6 connector pin descriptions

Pin	Signal Name	Usage	Description
59	USB_TYPC_CC1	Input/Output	USB type-C configuration channel 1. Connected to PMIC CC channel 1 pin.
61	USB_TYPC_CC2	Input/Output	USB type-C configuration channel 2. Connected to PMIC CC channel 2 pin.
11	+VRTC	Input	Real-time clock backup battery input to PMIC.
92	+VBATTERY	Input	Senses when battery is plugged in
99	+VBUS	Input	+VBUS from USB for PMIC detection when USB power source is plugged in.
97	VCONN_DCDC_EN	Output	General purpose input/output controlled by PMIC to enable load switch on expansion board to supply power to USB3.0 CC pins.
37	+VDC_IN	Input	+VDC_IN from DC jack for PMIC detection when DC jack is plugged in.
2,5,7,12,15,17	VSYS	Input	System power

7.2.3 J7 connector interface signals

Table 9 J7 connector pin descriptions

Pin	Signal Name	Usage	Description
52	AVS_M_CLK_A1	Output	Microphone clock for channel A (voice trigger microphone)
62	AVS_M_CLK_B1	Output	Microphone clock for channel B (secondary microphone)
66	AVS_M_DATA_1	Input	First microphone pair data
75	FLASH_TORCH	Output	Output from shutter switch when it's pressed full way. This switch state is used to trigger Xenon flash or LED flash
73	FLASH_RST_N	Input	Output from shutter switch when it's pressed halfway. This switch state is used to trigger the Auto focus LED for Xenon Flash or Torch mode for LED flash, active low
71	FLASH_TRIGGER	Input	Control signal to Xenon Flash to start charging capacitor
2,5,8,10,16,17,23,24,29,30,35,36,41,42,54,60,61,67,74,80,84,85,91,90,93,96,99	GND	Ground	System ground
43	I2C_1_SCL	Output	I ² C port 1 clock
45	I2C_1_SDA	Input/Output	I ² C port 1 data
9	ISH_UART_0_CTS	Input	Integrated sensor hub UART port 0 clear to send
11	ISH_UART_0_RTS	Output	Integrated sensor hub UART port 0 return to send. Hardware strap with reserved functionality.
13	ISH_UART_0_RXD	Input	Integrated sensor hub UART port 0 receive data
15	ISH_UART_0_TXD	Output	Integrated sensor hub UART port 0 transmit data. Hardware strap with reserved functionality.
26	I2C_2_SDA	Input/Output	I ² C port 2 data
28	I2C_2_SCL	Output	I ² C port 2 clock
12,14,38,40,69,81,83,92,94,98,100	Reserved	Reserved	Do not use; leave disconnected
88	PCIE1_CLK_DN	Output	PCIe port 1 clock negative
86	PCIE1_CLK_DP	Output	PCIe1 port 1 clock positive
50	PCIE1_CLKREQ_N	Input	PCIe1 port 1 clock request, active low
72	PCIE1_WAKE_N	Input	PCIe1 wake, active low
70	PCIE1_PERST_n	Output	PCIe1 reset, active low

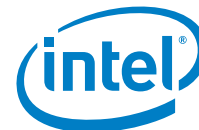
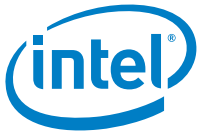

Table 9 J7 connector pin descriptions

Pin	Signal Name	Usage	Description
7	PMIC_SLPCLK_1	Output	32kHz RTC
59	SPI_0_CLK	Output	SPI port 0 clock
49	SPI_0_MISO	Input	SPI port 0 receive data
77	SPI_0_FS0	Output	SPI port 0 chip select 0. Hardware strap with reserved functionality.
79	SPI_0_FS1	Output	SPI port 0 chip select 1
53	SPI_0_FS2	Output	SPI port 0 chip select 2
57	SPI_0_MOSI	Output	SPI port 0 transmit data
47	UART_0_CTS	Input	UART port 0 clear to send
55	UART_0_RTS	Output	UART port 0 return to send
51	UART_0_RXD	Input	UART port 0 receive data (note UART_0_TXD is on the other 100p connector)
18	USBC_SEL	Output	PMIC mux control for USB type-C polarity
63	USB2_1_DN	Input/Output	USB 2.0 data negative
65	USB2_1_DP	Input/Output	USB 2.0 data positive
44	USB3_0_RX_DN	Input	USB 3.0 data receive negative
46	USB3_0_RX_DP	Input	USB 3.0 data receive positive
6	USB3_0_TX_DN	Output	USB 3.0 data transmit negative
4	USB3_0_TX_DP	Output	USB 3.0 data transmit positive
95	USB3_1_RX_DP	Input	USB 3.0 data receive negative
97	USB3_1_RX_DN	Input	USB 3.0 data receive positive
89	USB3_1_TX_DN	Output	USB 3.0 data transmit negative
87	USB3_1_TX_DP	Output	USB 3.0 data transmit positive
1,3,20,22, 32,34	VSYS	Input	System power



8 I2C Interfaces

The Intel® Joule™ module provides 7 master I2C interfaces.

8.1 I2C features

- ISH_I2C_0 and ISH_I2C_1 support standard, full and fast modes with a maximum data speed of 1.7Mbps
- I2C_0 through I2C_6 support standard, full, fast and high-speed modes with a maximum data speed of 3.4Mbps
- I²C master mode only; no support for multi-master mode
- Clock stretching by slave devices is possible
- Both 7-bit and 10-bit addressing modes are supported

8.2 I2C default configuration

Table 10 I2C mapping

Name	Description/Usage	Source	Destination
I2C_0	Dedicated EEPROM on expansion board (holds configuration table)	LPSS	Routed on module J7 for expansion board use
I2C_1	General usage	LPSS	Routed on module J7 for expansion board use
I2C_2	General usage	LPSS	Routed on module J7 for expansion board use
I2C_3	Camera support for DPHY 1.1	LPSS	Module Camera Connector - JCAM2
I2C_4	Camera support for DPHY 1.2 & 1.1	LPSS	Module Camera Connector - JCAM1
ISH_I2C_0	General usage; mapped to LPSS I2C_5	LPSS	Routed on module J6 for expansion board use
ISH_I2C_1	General usage; mapped to LPSS I2C_6	LPSS	Routed on module J6 for expansion board use

8.3 I2C signal group specifications

Refer to the Intel® Joule™ Expansion Board Design Guide for the specifications and PCB routing guidance for this interface.

9 Clock Specifications

Two module clocks, 19.2 MHz (CLK_19P2M) and 32.768 kHz (PMIC_SLPCLK_1) are routed out through the board-to-board connectors for use on expansion boards.

Refer to the Intel® Joule™ Expansion Board Design Guide for the specifications and PCB routing guidance of the clocks.

9.1 RTC backup battery

A backup power source is required for the RTC to operate robustly by preventing RTC data losses during unexpected power events. Implementation options are provided in the Intel® Joule™ Expansion Board Design Guide (listed in [Section 1.2](#)).

The most common solution is a non-rechargeable coin-cell battery connected to V_RTC at module connector J6, pin 11.



10 UART Specifications

10.1 UART availability

Table 11 Available UARTS

Name	Type	Flow Control
UART0	Full HSUART support - dedicated to Boot Mode strapping on expansion board	Yes
UART1	Receive / Transmit only	None
UART2	Full HSUART support	Yes
ISH UART 0	Full HSUART support	Yes

Refer to the Intel® Joule™ Expansion Board Design Guide for the specifications and PCB routing guidance for these interfaces.

11 I2S Specifications

One I2S port is provided by the J7 board-to-board connector interface.

11.1 I2S signal group specifications

Refer to the Intel® Joule™ Expansion Board Design Guide for the specifications and PCB routing guidance for this interface.

11.1.1 I2S available formats

The I2S formats listed in Table 12 have not been verified and are subject to change.

Table 12 I2S available configuration formats

Mode	Priority	Frame rate	Bits/sample	Number of slots	Frame to data offset	Frame polarity	Frame width	Frame rate inaccuracy	Notes
I²S master	1	192K,96K, 48K, 16K, 8K	16,24	2	1	0-left, 1-right	50/50	0%	Standard I ² S protocol. 50% duty
PCM slave-SFS	1	192K,96K, 48K, 44.1K, 16K, 8K	16,24	192kHz: 2 96 kHz: 4 All else: 1 to 6	0	High			
PCM slave - LFS	1	192K, 96K, 48K, 44.1K, 16K,8K	16,24	192 kHz: 2 96 kHz: 4 All else: 1 to 6	0	High		0%.	
PCM master -SFS	1	192K, 96K, 48K, 16K, 8K	16, 24	192 kHz: 2 All else: 1 to 4	0	High	1 bit clock wide	0%	Rising edge frame sensitive. Design supports more frame- to-data offset options.
PCM master - LFS	1	192K, 96K, 48K, 16K, 8K	16,24	192 kHz: 2 All else: 1 to 4	0	High	1-bit to n-bit clocks	0%	Design supports width > 1 slot.
Left justified master	2	192K,96K, 48K	16,24	2	0	0-left, 1-right	50/50	0%	Design supports flipping polarity on the frame signal.
I²S slave	3	192K,96K, 48K,44.1K	16,24	2	0	0-left, 1-right	50/50	0%	
Left justified slave	3	192K,96K, 48K	16,24	2	0	0-left, 1-right	50/50	0%	
Right justified	Not supported.								

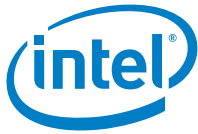

11.2 Digital microphone ports

Intel® Joule™ supports microphones that use the PDM digital microphone standard and attached to the module through the AVS_M interface. Two microphones can share one data line by using time domain multiplexing to the two slots.

PDM microphones are enabled and disabled by the clock signal. Absence of clock signal will switch microphone to sleep mode, which can be utilized in system power management.

Additionally the microphones can be power-gated to cut the power consumption to zero when microphones are not used.

Refer to the Intel® Joule™ Expansion Board Design Guide for the specifications and PCB routing guidance for this interface.

12 GPIO Specifications

12.1 Dedicated GPIO lines

The Intel® Joule™ module provides 8 dedicated GPIO lines (GPIO_0 - 6, GPIO_17 and GPIO_22) connected to the core processor.

12.2 Reconfigurable interfaces buses as GPIO

Many interface lines on the module can be reconfigured as GPIO lines by defining a configuration table stored within an EEPROM device on the expansion board.

The BIOS loads a default configuration (see BIOS release notes for more details) if the EEPROM appears empty or is found unreadable by the BIOS. The configuration EEPROM is only read at cold boot and the configuration is retained during reset. Specific outputs can be set or cleared before entering a sleep state.

12.3 GPIO internal pull UP / pull DOWN resistors

Each GPIO line can employ an internal pull UP or pull DOWN resistor, this is also defined within the configuration table and stored in the expansion board EEPROM device and read by the BIOS at cold boot.

See the Intel® Joule™ BIOS Guide for pull UP and pull DOWN configuration details and the Intel® Joule™ Expansion Board Design Guide for the specifications and PCB routing guidance of the GPIO interfaces.

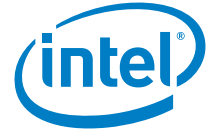

12.4 Linux* GPIO to function mapping

Default configuration for Linux* GPIO number to signal on the Intel® Joule™ module.

Table 13 Linux* GPIO number to module signal

Linux* GPIO	Module Signal Name	Linux* GPIO	Module Signal Name
270	DISPLAY_0_BIAS_EN	413	SPI_0_FS2
271	DISPLAY_0_BKLTEN	414	SPI_0_MOSI
272	BLDRW_0_PWM	415	SPI_0_MISO
315	I2C_0_SDA	416	SPI_1_CLK
316	I2C_0_SCL	417	SPI_1_FS0
317	I2C_1_SDA	419	SPI_1_FS2
318	IC2_1_SCL	421	SPI_1_MISO
319	I2C_2_SDA	422	SPI_1_MOSI
320	I2C_2_SCL	446	BTN_N
331	ISH_I2C_0_SDA	456	DISPLAY_0_RST_N
332	ISH_I2C_0_SCL	462	UART_0_TXD
333	ISH_1_SDA	463	PWM0
334	ISH_1_SCL	464	PMW1
365	PMIC_PWRGOOD	465	PMW2
366	PMIC_RESET_N	466	PMW3
367	PMIC_SLPCLK_1	467	UART_0_RXD
378	I2S_1_MCLK	469	UART_0_RTS
379	I2S_1_BCLK	470	UART_0_CTS
380	I2S_1_WS_SYNC	471	UART_1_RXD
381	I2S_1_RXD	472	UART_1_TXD
382	I2S_1_TXD	483	ISH_UART_1_RXD
383	AVS_M_CLK_A1	484	ISH_UART_1_TXD
384	AVS_M_CLK_B1	485	ISH_UART_1_RTS
385	AVS_M_DATA_1	486	ISH_UART_1_CTS
410	SPI_0_CLK	491	FLASH_RST_N
411	SPI_0_FS0	492	FLASH_TORCH
412	SPI_0_FS1	493	FLASH_TRIGGER

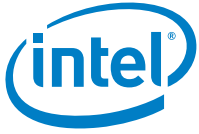

13 Pulse Width Modulators

The default BIOS configuration table defines four dedicated PWM outputs as PWM_0, PWM_1, PWM_2, and PWM_3, each with programmable frequency and duty cycle.

Table 14 shows examples of hardware (register) based PWM programming:

The PWM variables that control frequency and duty cycle are controlled by the BASE_UNIT_INT, BASE_UNIT_FRAC, and ON_TIME_DIVISOR register settings and the following equations:

13.1 PWM frequency formula:

$$Frequency \approx 19.2 \text{ MHz} * \frac{(PWM \text{ BASE UNIT})_d}{256}$$

13.2 PWM duty cycle formula:

$$Duty \text{ Cycle} \approx \frac{(PWM \text{ ON TIME DIVISOR})_d}{256}$$

Note: Consult specific operating system documents if manipulating PWM settings at the OS level.

Table 14 PWM programming examples

Integer part of BASE_UNIT_INT (bits 29:22)	Fractional part of BASE_UNIT_FRAC (bits 21:8)	Decimal base unit value	ON_TIME_DIVISOR (bits 7:0)	Base unit type	PWM frequency (Hz)	PWM period (uSec)	Duty Cycle
0000_0000b	00_0100_0000_0000b	0.0625	0000_1000b	fractional	4,688	213	50%
0000_0000b	00_0010_0000_0000b	0.03125	0000_0100b	fractional	2,344	427	50%
0000_0000b	00_0001_0000_0000b	0.015625	0000_0001b	fractional	1,172	853	50%

14 Universal Serial Bus

14.1 Available USB ports

The Intel® Joule™ module provides two USB 3.0 ports; one Type C (OTG) and one USB 3.0 host mode and a USB 2 host port.

Table 15 USB port types

Signal name	Port	Description
USB2_0_DP	0	USB 2 data positive
USB2_0_DN		USB 2 data negative
USB3_1_RX_DP	1	USB 3 receive data positive
USB3_1_RX_DN		USB 3 receive data negative
USB3_1_TX_DP		USB 3 transmit data positive
USB3_1_TX_DN		USB 3 transmit data negative

Refer to the Intel® Joule™ Expansion Board Design Guide for the specifications and PCB routing guidance for this interface.