



## 4A, 650V N-CHANNEL POWER MOSFET

TO-220F-3L(\*Prefix :F)

### Description

The F4N65L is a high voltage power MOSFET and is designed to have better characteristics, such as fast switching time, low gate charge, low on-state resistance and have a high rugged avalanche characteristics. This power MOSFET is usually used at high speed switching applications in switching power supplies and adaptors.

### Features

- $R_{DS(ON)} < 2.6 \Omega @ V_{GS}=10V, I_D=2.0A$
- Fast switching capability
- 100% Avalanche tested
- 100%  $\Delta V_{DS}$  tested

### Mechanical data

- Case: TO-220F-3L
- pprox. Weight: 1.77g (0.062oz)
- Lead free finish, RoHS compliant
- Case Material: "Green" molding compound, UL flammability classification 94V-0, "Halogen-free".

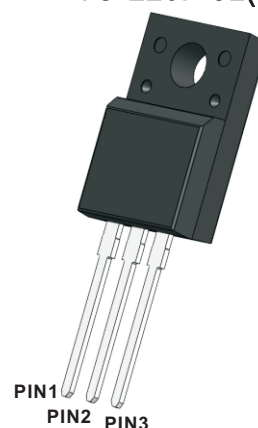

RoHS  
COMPLIANT

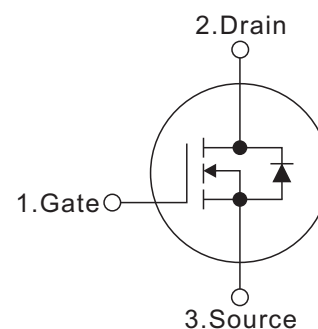

### Packing Marking And Ordering Information

Device Package	Device	Marking	Packing Type	QTY Per Tube	Inner box	Per Carton
TO-220F-3L	F4N65L	F4N65L	Tube	50 Pcs	2,500 Pcs	5,000 Pcs

### Absolute Maximum Ratings (Ta=25°C, Unless Otherwise Specified)

Parameter	Symbols	Ratings	Units
Drain-Source Voltage	$V_{DSS}$	650	V
Gate-Source Voltage	$V_{GSS}$	$\pm 30$	V
Continuous Drain Current $T_c=25^\circ C$ $T_c=100^\circ C$	$I_D$	4.0 2.5	A
Pulsed Drain Current (Note 2)	$I_{DM}$	16	A
Avalanche Energy Single Pulsed (Note 3)	$E_{AS}$	173	mJ
Power Dissipation ( $T_c = 25^\circ C$ )	$P_D$	50	W
Operating junction and storage temperature	$T_J, T_{STG}$	-55 ~ +150	$^\circ C$

Notes: 1. Absolute maximum ratings are those values beyond which the device could be permanently damaged.

Absolute maximum ratings are stress ratings only and functional device operation is not implied.

2. Repetitive Rating: Pulse width limited by maximum junction temperature.

3. L = 100mH, IAS = 4.1A, VDD = 50V, RG = 25  $\Omega$ , Starting  $T_J = 25^\circ C$

### Thermal Resistance

Parameter	Symbols	Ratings	Units
Thermal resistance, junction – case.	$R_{thJC}$	4	$^\circ C/W$
Thermal resistance, junction – ambient(min. footprint)	$R_{thJA}$	63	$^\circ C/W$



Electrical Characteristics (ta=25°C, Unless Otherwise Specified)

Parameter	Symbols	Test Conditions	Min	Typ	Max	Units
<b>Off Characteristics</b>						
Drain-Source Breakdown Voltage	$BV_{DSS}$	$V_{GS}=0V, I_D=250\mu A$	650			V
Drain-Source Leakage Current	$I_{DSS}$	$V_{DS}=650V, V_{GS}=0V$			1.0	$\mu A$
Gate- Source Leakage Current	Forward	$V_{GS}=30V, V_{DS}=0V$			100	nA
	Reverse	$V_{GS}=-30V, V_{DS}=0V$			-100	
<b>On Characteristics</b>						
Gate Threshold Voltage	$V_{GS(TH)}$	$V_{DS}=V_{GS}, I_D=250\mu A$	2.0		4.0	V
Static Drain-Source On-State Resistance	$R_{DS(ON)}$	$V_{GS}=10V, I_D=2.0A$		2.4	2.6	$\Omega$
Transconductance	$g_{fs}$	$V_{DS}=15V, I_D=2A$		2.7		S
<b>Dynamic Characteristics</b>						
Input Capacitance	$C_{ISS}$	$V_{DS}=25V,$		581		pF
Output Capacitance	$C_{OSS}$	$V_{GS}=0V,$		63		pF
Reverse Transfer Capacitance	$C_{RSS}$	$f=1.0MHz$		11		pF
Gate resistance	$R_G$			1.9		$\Omega$
<b>Switching Characteristics</b>						
Total Gate Charge (Note 1)	$Q_G$	$V_{DS}=480V, V_{GS}=10V,$		25		nC
Gate-Source Charge	$Q_{GS}$	$I_D=4A$		17		nC
Gate-Drain Charge	$Q_{GD}$	(NOTE1,2)		20		nC
Turn-On Delay Time (Note 1)	$t_{D(ON)}$	$V_{DS}=325V, I_D=4A$		45		ns
Turn-On Rise Time	$t_R$	$R_G=2.5\Omega$		100		ns
Turn-Off Delay Time	$t_{D(OFF)}$	(NOTE1,2)		200		ns
Turn-Off Fall Time	$t_F$			130		ns
<b>Drain-Source Diode Characteristics And Maximum Ratings</b>						
Maximum Body-Diode Continuous Current	$I_S$				4	A
Drain-Source Diode Forward Voltage (Note 1)	$V_{SD}$	$I_{SD}=4A, V_{GS}=0V$			1.3	V
Reverse Recovery Time (Note 1)	$t_{rr}$	$I_F=4A$		48		ns
Reverse Recovery Charge	$Q_{rr}$	$di/dt=100A/\mu s$		370		nC

Notes:

1. Pulse Test: Pulse width  $\leq 300\mu s$ , Duty cycle  $\leq 2\%$ .
2. Essentially independent of operating temperature.



Test Circuits and waveforms

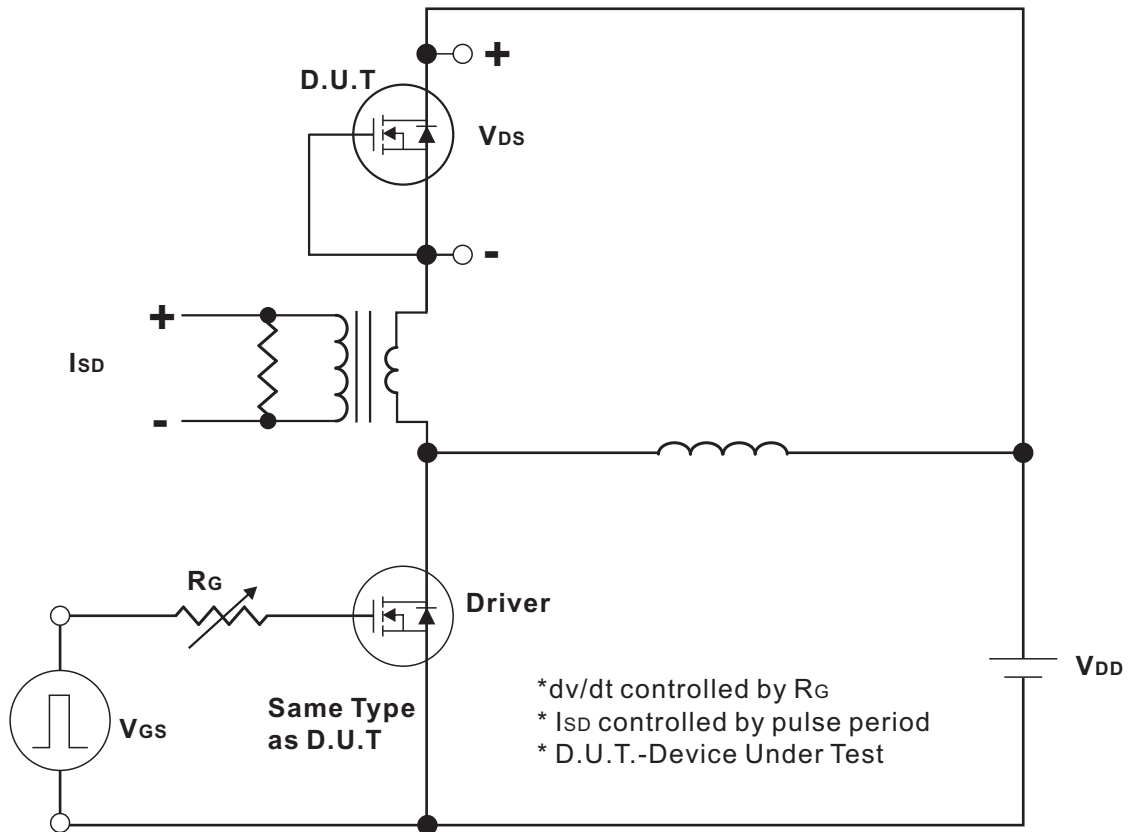

Peak Diode Recovery dv/dt Test Circuit

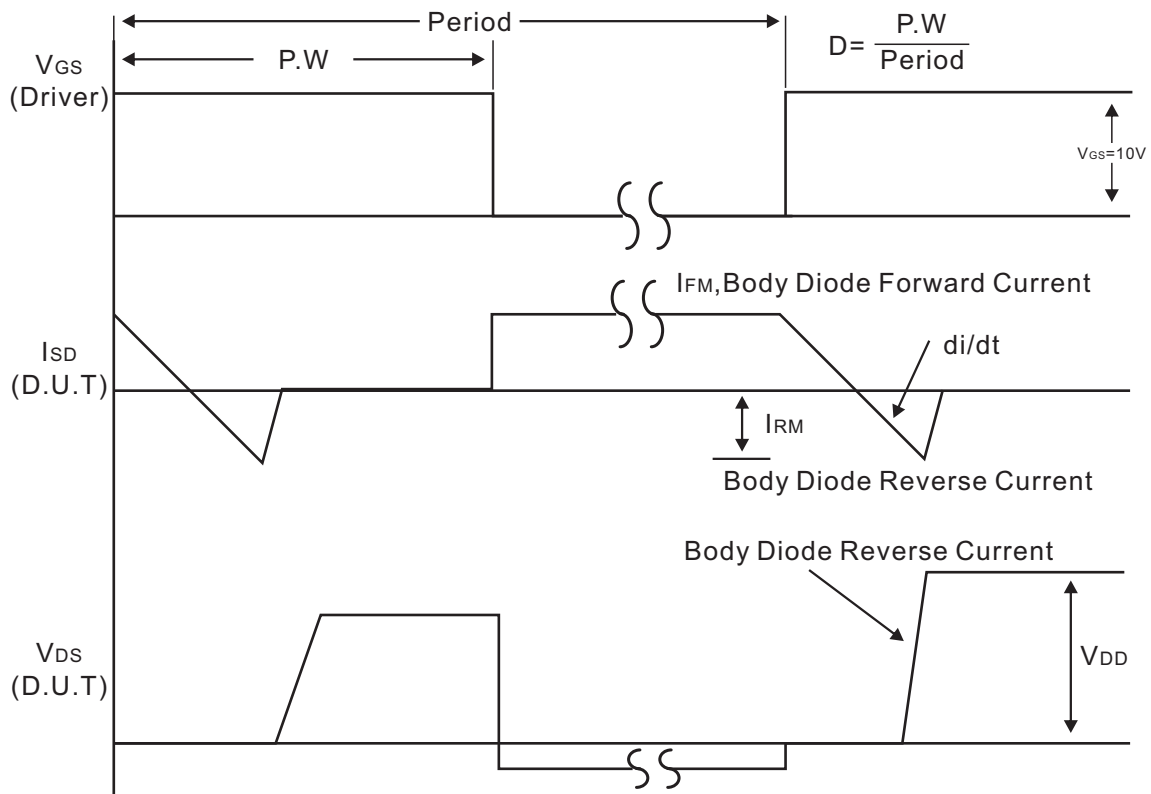

Peak Diode Recovery dv/dt Waveforms



### Test Circuits and waveforms

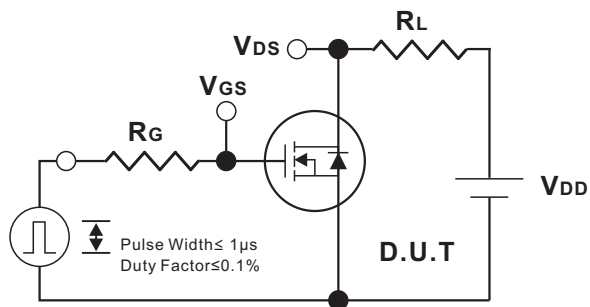

Switching Test Circuit

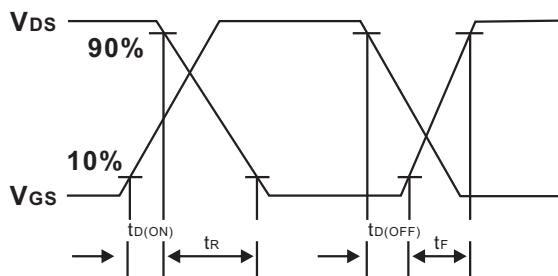

Switching Waveforms

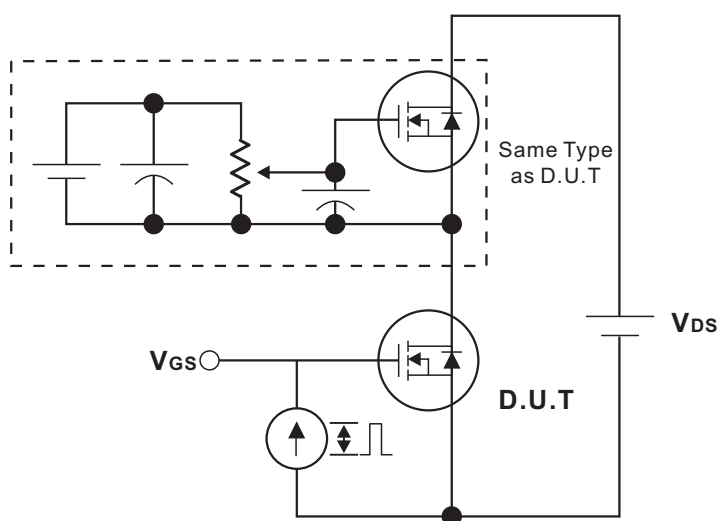

Gate Charge Test Circuit

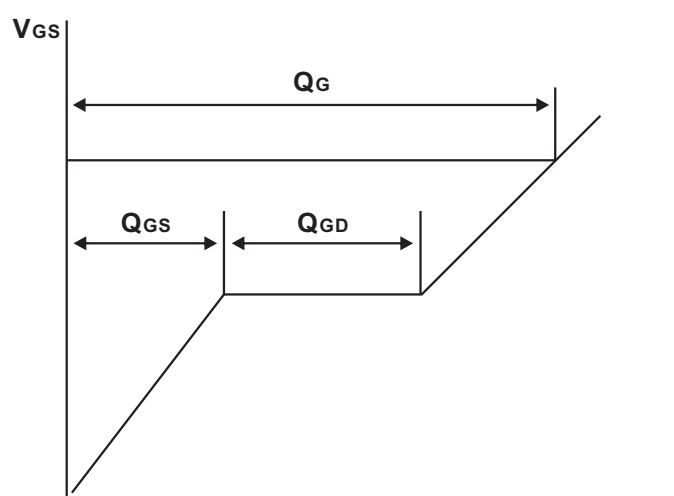

Charge  
Gate Charge Waveform

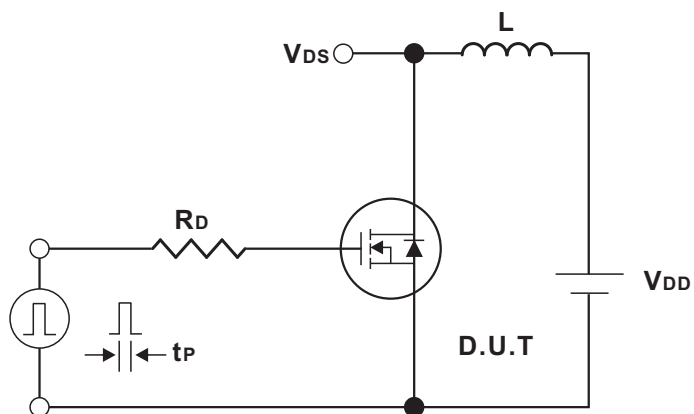

Unclamped Inductive Switching Test Circuit

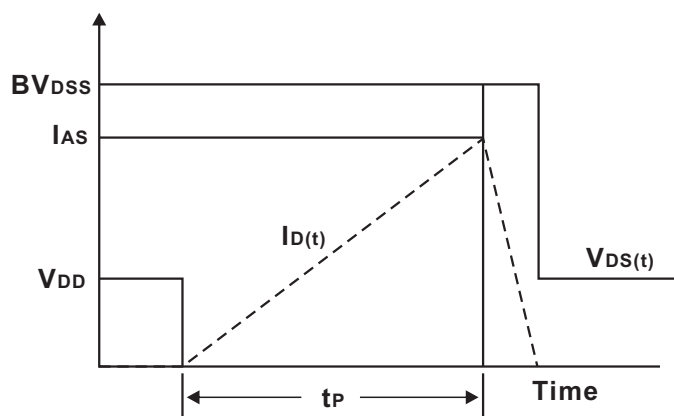

Unclamped Inductive Switching Waveforms



### Typical Characteristics

Fig.1 Output characteristics

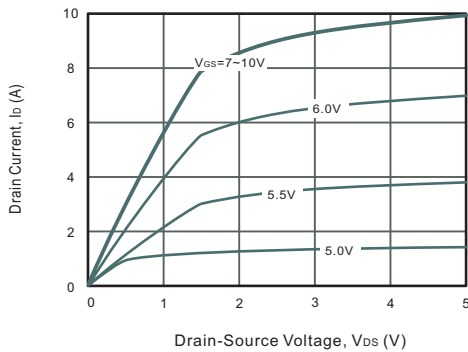

Fig.2 Power Dissipation

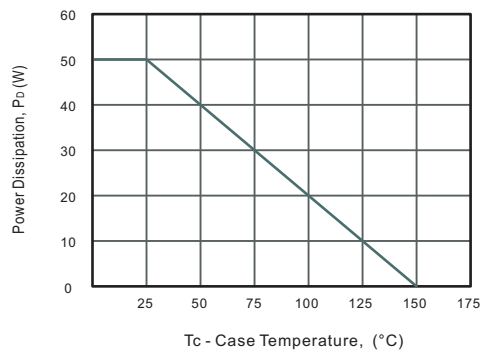

Fig.3 Drain Current Derating

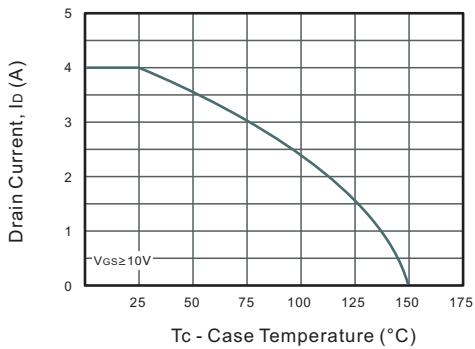

Fig.4 Drain-Source On-Resistance vs. Drain Current

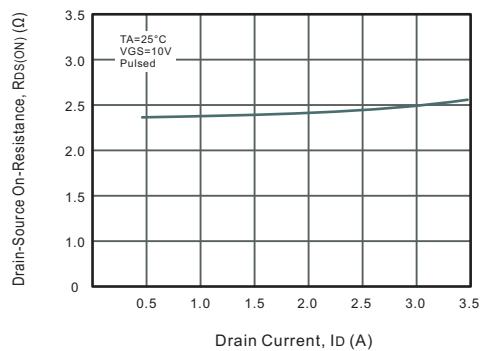

Fig.5 Gate Threshold Voltage vs. Junction Temperature

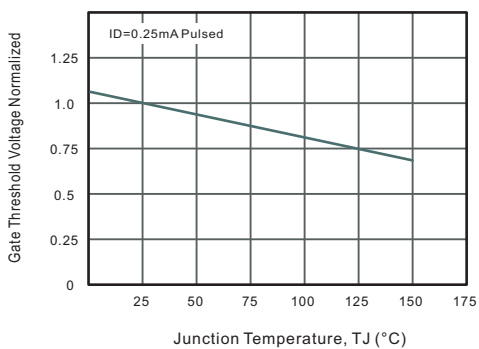

Fig.6 Body-diode Forward Characteristics

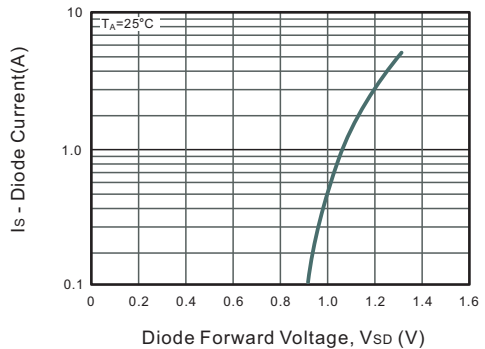

Fig.7 Drain-Source On-Resistance vs. Junction Temperature

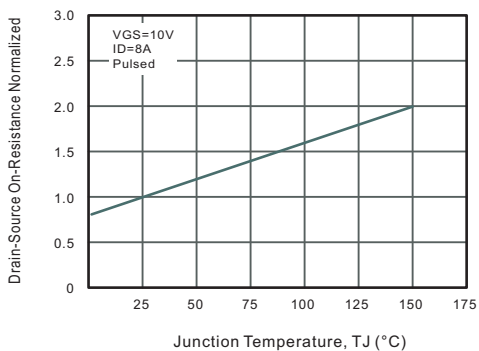
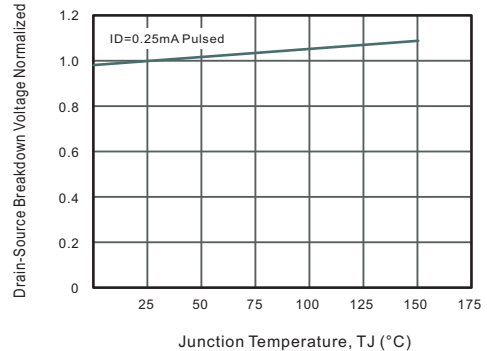

Fig.8 Breakdown Voltage vs. Junction Temperature





Typical Characteristics

Fig.9 Capacitance Characteristics

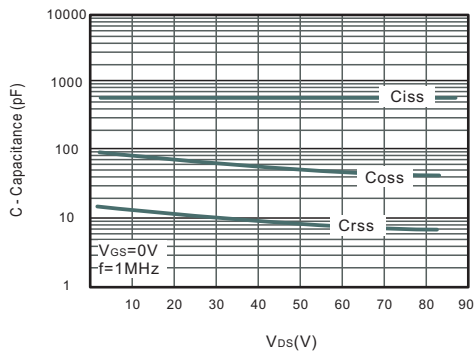

Fig.10 Gate Charge Characteristics

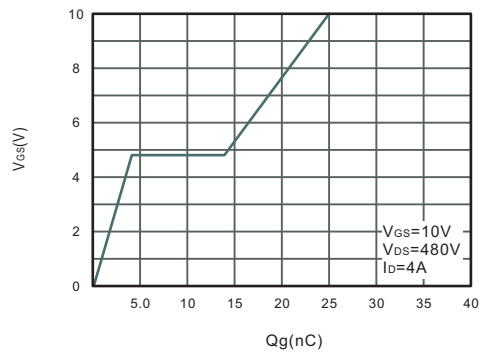

Fig.11 Safe Operating Area

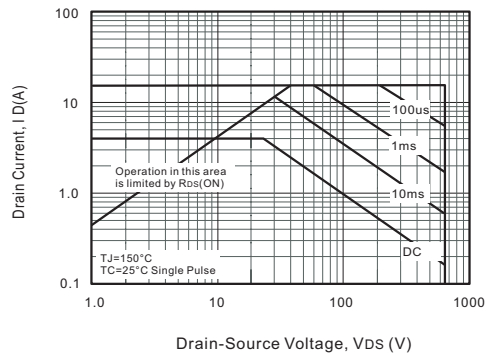
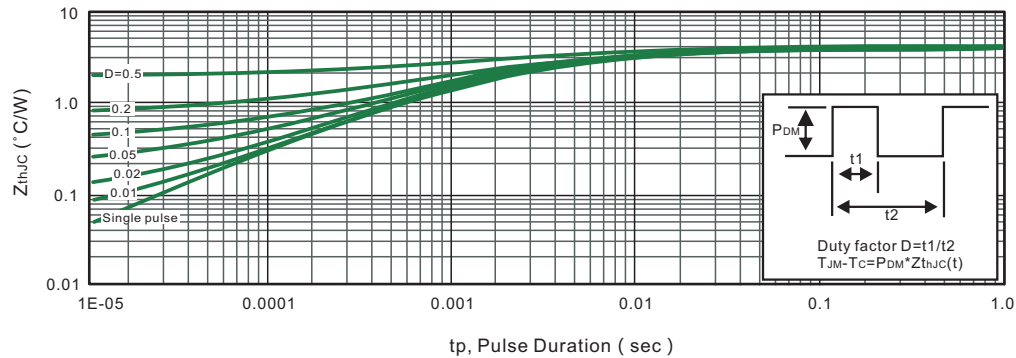

Fig.12 Max. Transient Thermal Impedance





Package Outline  
Through Hole Package ; 3 leads

TO-220F-3L

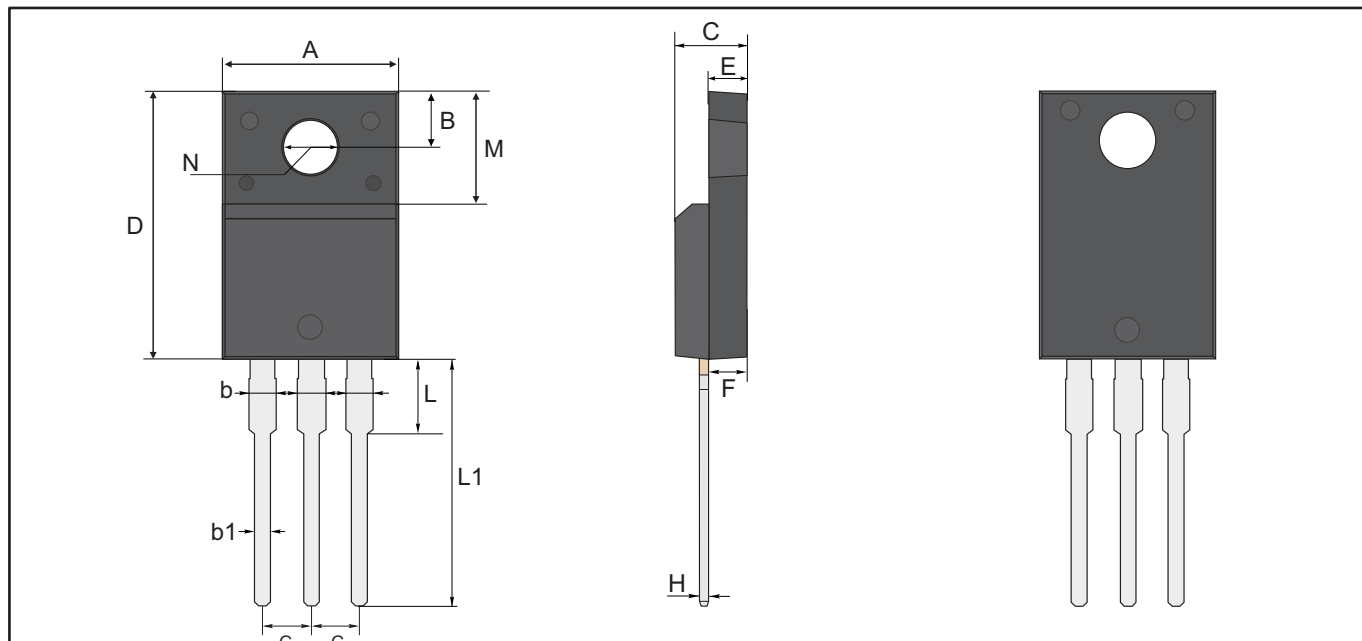

TO-220F-3L Mechanical data

UNIT		A	B	b	b1	C	D	E	F	G	H	L	L1	M	N
mm	max	10.28	3.37	1.44	0.9	4.9	16.07	2.74	2.74	2.64	0.6	3.38	13.7	6.98	3.18 typ.
	typ	10.18	3.27	1.34	0.8	4.7	15.87	2.54	2.54	2.54	0.5	3.18	13.5	6.68	
	min	10.08	3.17	1.24	0.7	4.5	15.67	2.34	2.34	2.44	0.4	2.98	13.3	6.38	
mil	max	405	133	57	35	193	633	108	108	104	24	133	539	275	125 typ.
	typ	401	129	53	31	185	625	100	100	100	20	125	531	263	
	min	397	125	49	28	177	617	92	92	96	16	117	524	251	

Marking Diagram

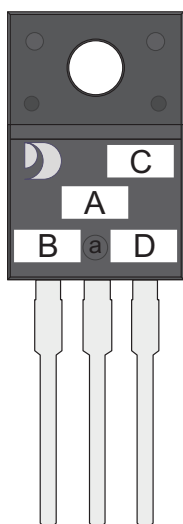

- Unmarkable Surfacea
- Marking Composition Field
- a: Ejector Pin Mark
- A: Marking Area
- B: Lot Code
- C: Additional Information
- D: Date Code (YWW)
- Y: Years(0~9)
- WW: Week



### Important Notice and Disclaimer

Jingdao Microelectronics reserves the right to make changes to this document and its products and specifications at any time without notice. Customers should obtain and confirm the latest product information and specifications before final design, purchase or use.

Jingdao Microelectronics makes no warranty, representation or guarantee regarding the suitability of its products for any particular purpose, not does Jingdao Microelectronics assume any liability for application assistance or customer product design.

Jingdao Microelectronics does not warrant or accept any liability with products which are purchased or used for any unintended or unauthorized application.

No license is granted by implication or otherwise under any intellectual property rights of Jingdao Microelectronics.

Jingdao Microelectronics products are not authorized for use as critical components in life support devices or systems without express written approval of Jingdao Microelectronics.